

# Metro Area Travel Improvement Study

## Phase 3 – Freeway System Vision and Implementation Plan

September  
2019

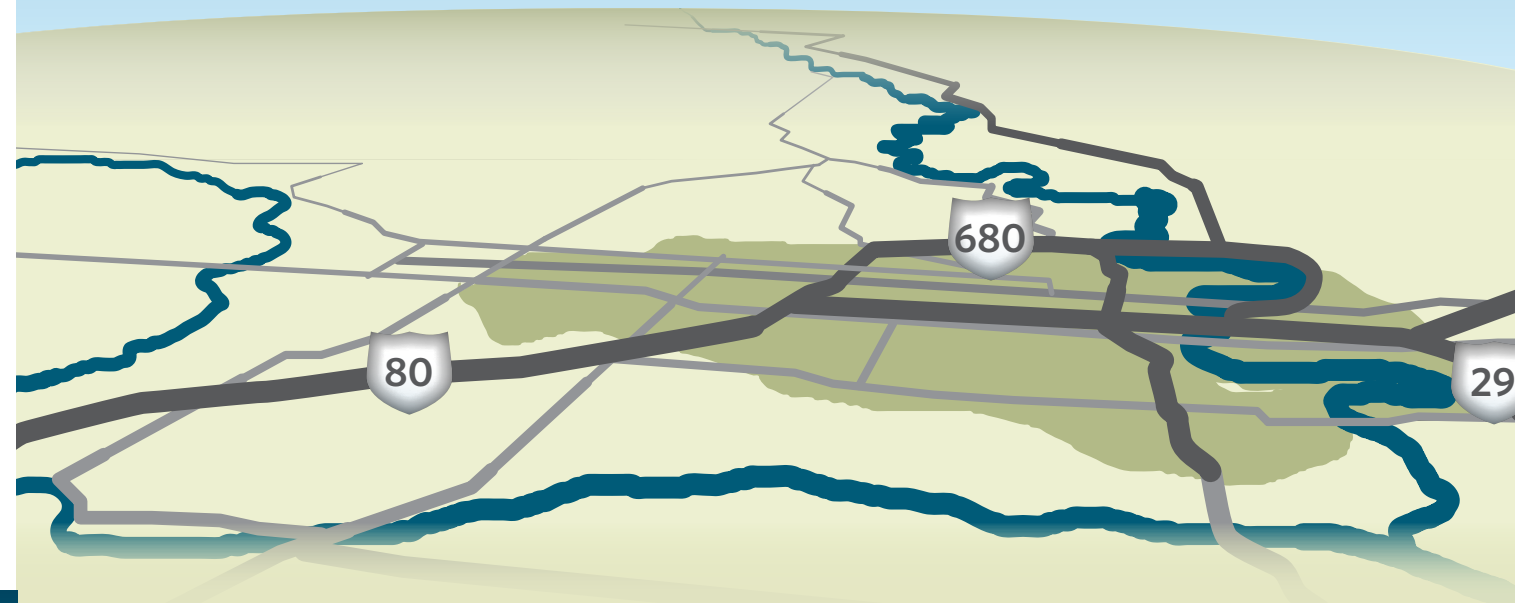

**SYSTEM  
PRESERVATION**



**CONGESTION  
REDUCTION**



**MOBILITY &  
ACCESSIBILITY**



**STEWARDSHIP &  
ENVIRONMENT**



**SAFETY**







## Contents

Chapter 1 - Introduction .....	1	Appendix A - Environmental Resources .....	A
Study Purpose .....	1	Appendix B - I-80 .....	B
Study Goals and Objectives .....	1	Appendix C - I-480 .....	C
Study Approach .....	1	Appendix D - I-680 .....	D
Study Area .....	1	Appendix E - US-75 (Kennedy Freeway) .....	E
Study Background .....	2	Appendix F - US-6 (West Dodge Road) .....	F
Summary of MTIS Phases .....	2		
Chapter 2 - Concept Proofing and Evaluation Methodologies .....	3		
Guiding Principles .....	3		
Methodologies .....	3		
Chapter 3 - Corridor Summaries .....	6		
I-80 Corridor .....	6		
I-480 Corridor .....	10		
I-680 Corridor .....	11		
US-75 (Kennedy Freeway) Corridor .....	13		
US-6 (West Dodge Road) Corridor .....	15		
Other Strategy Considerations .....	19		
Chapter 4 – Implementation Plan .....	22		
System Preservation Projects .....	22		
Expansion Projects .....	22		
Implementation Plans .....	22		
Expansion Project Sheets .....	26		
Chapter 5 - Outreach .....	60		
MTIS Management Committee Meetings .....	60		
MTIS Executive Committee Meetings .....	60		
Concept Proofing and Implementation Plan Workshops .....	60		
Regulatory Agency Meeting .....	60		
MAPA MPO Certification Review .....	60		
Stakeholder Meeting .....	60		
NDOT Leadership Meeting .....	60		
Public Involvement .....	60		
Coordination with Other Studies and Projects .....	60		
Chapter 6 - Summary .....	61		

## List of Tables

Table 2.1. Unit Costs for Expansion and System Preservation Projects .....	5
Table 3.1. Advantages and Disadvantages of Parclo and DDI Configurations .....	8
Table 3.2. Summary of I-80 Concepts and Sub-Options .....	9
Table 3.3. Summary of I-480 Concepts and Sub-Options .....	11
Table 3.4. Summary of I-680 Concepts and Sub-Options .....	13
Table 3.5. Summary of US-75 (Kennedy Freeway) Concepts and Sub-Options .....	15
Table 3.6. Summary of US-6 (West Dodge Road) Concepts and Sub-Options .....	18
Table 3.7. Queue Storage Analysis – Eastbound West Dodge Road .....	21
Table 3.8. Queue Storage Analysis – Westbound West Dodge Road .....	21
Table 4.1. Project Sheet Directory .....	26

## List of Figures

Figure 1.1. Study Area and Roadways .....	1
Figure 1.2. Omaha Interstate Reconstruction Projects (1989–1999) .....	2
Figure 4.1. Needs-Based Implementation Plan .....	24
Figure 4.2. Constrained Implementation Plan .....	25



# Chapter 1 - Introduction

## Study Purpose

The Metro Area Travel Improvement Study (MTIS) is a collaboration between the Nebraska Department of Transportation (NDOT) and the Omaha-Council Bluffs Metropolitan Area Planning Agency (MAPA). MTIS is a comprehensive transportation study that recognizes that future interstate and freeway system needs are linked with arterial, local road, and transit system needs and investment decisions in the MAPA region. This approach provides the opportunity for identifying an optimum area-wide, multimodal transportation system where investment decisions are made understanding the comprehensive travel network and leveraging available strategies and options to efficiently meet community needs. The purpose of the study was to:

- develop a comprehensive, multimodal, multisystem plan;
- prioritize projects for the short term, mid-term, and long term;
- consider funding constraints and Transportation Improvement Program (TIP) shortfalls.

## Study Goals and Objectives

The following performance goals, initially developed from the priorities identified at the study kick-off meeting, were discussed and vetted by workshop participants to ensure that these goals provided an accurate expression of transportation priorities for the region while supporting the study purpose:

- **System Preservation:** Achieve a state of good repair by prioritizing projects that address timely and cost-beneficial asset rehabilitation.
- **Congestion Reduction:** Reduce the growth of peak-period delay on freeways, and improve system reliability and overall performance.
- **Mobility and Accessibility:** Reduce the growth of peak-period travel times for all modes, and increase transit access and ridership.
- **Stewardship and Environment:** Address air quality concerns, consider land use in all improvements, and incorporate economic, social, and environmental criteria in project selection and programming decisions.
- **Safety:** Reduce fatalities and serious injuries.

## Study Approach

The study used a phased approach. The study phases included the following:

- **Phase 1:** Existing/Future No-Build Conditions Review (companion report)
- **Phase 2:** Strategy/Alternative Development and Evaluation (companion report)
- **Phase 3:** Freeway System Vision and Implementation Plan (this report)

## Study Area

The first phase of the study defined the study area boundary and roadways based on discussions with NDOT, MAPA, and jurisdictional stakeholders. The MTIS study area is shown in **Figure 1.1** and includes the following elements:

- The study area boundary was based on MAPA’s designated Transportation Management Area (TMA), which includes all of Douglas and Sarpy Counties in Nebraska, western parts of Pottawattamie County in Iowa, and a small segment of Cass County along US-75 northwest of Plattsmouth in Nebraska. The study area was expanded slightly into the northwest corner of Mills County, Iowa, between the Missouri River and I-29, to include the US-34 connection between I-29 and US-75.
- All MAP-21 National Highway System (NHS) routes are included in the study area. Non-NHS routes that were considered priority corridors by NDOT and MAPA were included as well.
- The freeway system in Iowa was not evaluated in MTIS because the Council Bluffs Interstate System is currently undergoing a multi-year reconstruction and expansion that will address long-term mobility and safety needs. The Council Bluffs Interstate System projects contained in the current TIP were included in the “existing-plus-committed” (E+C) future regional system assumed to be in place for the baseline conditions analysis.

**Figure 1.1. Study Area and Roadways**

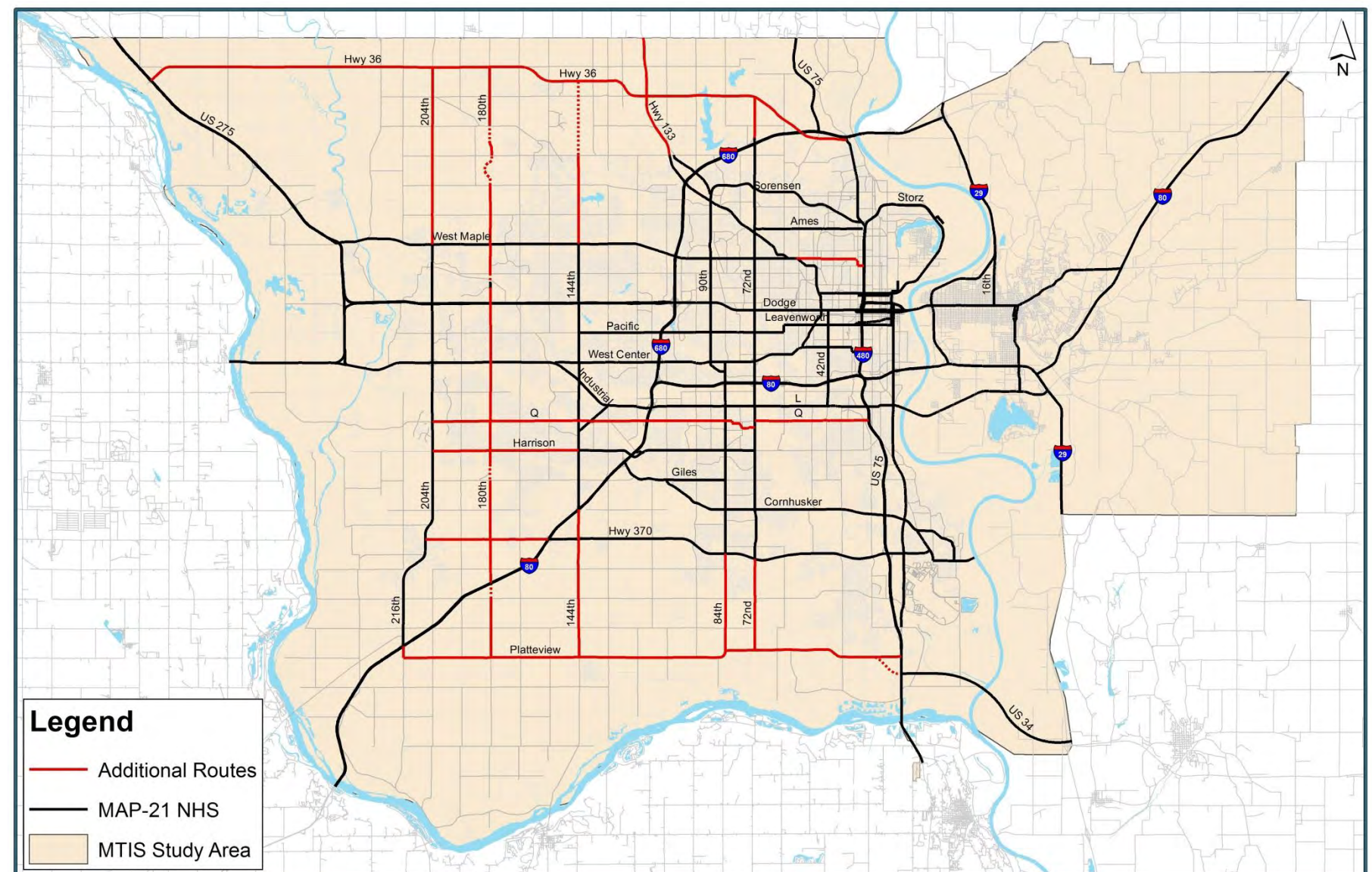

## Study Background

### Previous Freeway Master Plan and Reconstruction Projects

The previous freeway master plan for the Omaha metropolitan area was completed in 1985. The objective of the study was to develop a rehabilitation plan that corrected the existing geometric and operational deficiencies and accommodated future traffic requirements in the year 2000 and beyond. The plan also included a construction phasing plan for rehabilitation within the framework of the long-range plan. Reconstruction projects recommended by the master plan have been completed over the last 20+ years and are shown in **Figure 1.2**.

The preferred ultimate plan from 1985 is nearing the end of its useful life. NDOT addressed a series of bottlenecks on the freeway system with a series of construction projects in 2014. These bottleneck-reduction projects addressed localized congestion issues, but will not address the system-wide congestion issues expected in the future. A primary goal of MTIS was to provide NDOT with a new freeway vision for the Omaha metropolitan area.

**Figure 1.2. Omaha Interstate Reconstruction Projects (1989–1999)**

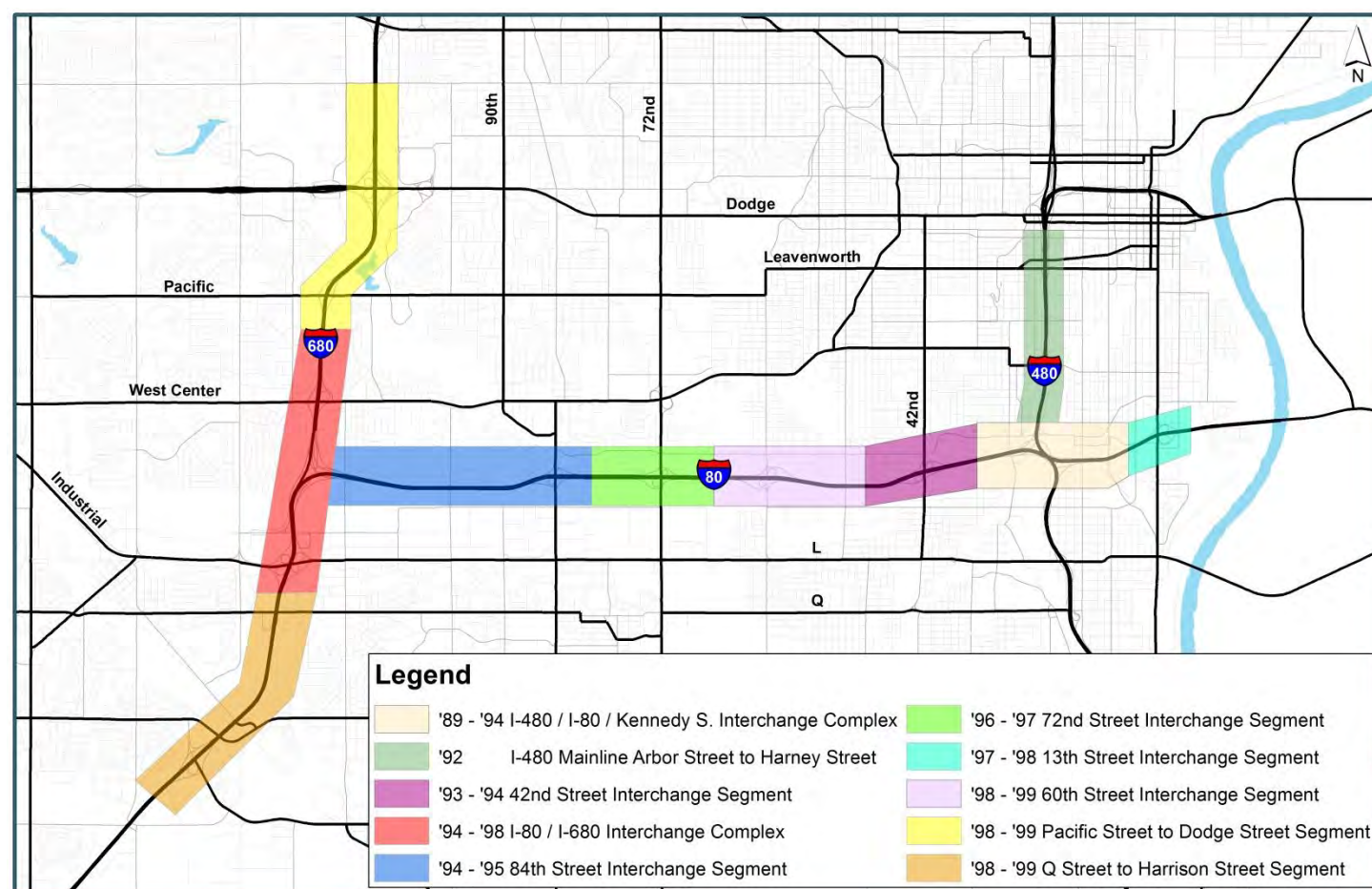

### Long-Range Transportation Plan Process

As part of its role as the Omaha-Council Bluffs metropolitan area's Metropolitan Planning Organization (MPO), MAPA receives federal funding for transportation projects and programs. MAPA is required to update its Long-Range Transportation Plan (LRTP) every 5 years. The LRTP is a document that identifies:

- a regional transportation vision for the community;
- current and future transportation system needs;
- a reasonably fundable list of projects, programs, and strategies to implement over the next 20+ years.

The 2040 LRTP, adopted in 2015, is considered an interim document that builds off of the products and vision provided by the 2035 LRTP. The technical analyses completed as a part of the MTIS will help drive development of successor metropolitan transportation plans, including a 2050 LRTP.

### Summary of MTIS Phases

MTIS Phase 1 included a comprehensive planning effort that established the framework for later study investment decisions. It included an area-wide travel assessment of existing and future no-build conditions, ensuring that the Study Team had a solid base condition for Phase 2 and Phase 3.

Phase 2 included development and testing of corridor-level and location-specific strategies to meet the needs identified in Phase 1. The corridor-level and location-specific strategies and alternatives were developed to a level where comparisons could be made in order to identify viable and feasible improvement strategies. These strategies were then combined into comprehensive regional-level packages and evaluated against MTIS goals and performance measures. From this evaluation, an overall package (Strategy Package 7) was selected. Subsequently, focused concepts for the freeway corridors in the study area were developed and evaluated to identify concepts to be carried forward to Phase 3.

Phase 3 focused solely on the freeway corridors of the MTIS network to address the following questions:

- What is the "vision" for the freeway system in the Omaha metropolitan area?
- How are we going to get there?

Phase 3 included further development, though limited in scope, of critical areas of the freeway corridor-level concepts and sub-options from Phase 2 to provide reasonable proof of concept feasibility as well as an evaluation of the concepts relative to various criteria (see **Chapter 2**). From this effort, the recommended vision for freeway improvements was developed (see **Chapter 3**). Phase 3 also included identifying two alternative implementation plans for the freeway vision (see **Chapter 4**). These plans include projects for addressing the operational needs of the freeway system as well as projects for addressing the system preservation needs of the freeway system.

For clarity, the term "alternatives" used in MTIS Phase 2 was changed to "concepts" in Phase 3 because the term "alternatives" is typically associated with the National Environmental Policy Act (NEPA) process. MTIS is a pre-NEPA planning study, and the various corridor-level improvement options that are being considered as part of MTIS have not yet been through the NEPA process.



## Chapter 2 - Concept Proofing and Evaluation

### Methodologies

This chapter summarizes the guiding principles and methodologies used in concept proofing and evaluation of the freeway concepts and sub-options carried forward from Phase 2. Concept proofing involved the development of conceptual alignments, profiles, and/or cross sections in limited locations to the extent necessary to establish a reasonable level of confidence in concept feasibility and to permit identification of right-of-way impacts.

#### Guiding Principles

A number of guiding principles were applied during the development of freeway improvement concepts in Phase 2 and during the concept proofing and evaluation in Phase 3. Some of these principles were articulated by NDOT early in the process while others “emerged” during ongoing coordination with NDOT as the improvement concepts were developed and evaluated. The guiding principles included the following:

- The corridors in the Omaha metropolitan area freeway system were prioritized as follows, and that priority was considered in evaluating the relative importance of maintaining traffic flow in accordance with operational criteria (for example, level of service):
  - I-80 (highest priority)
  - I-480 and I-680 (next highest priority)
  - West Dodge Road and US-75 (lowest priority)
- For the West Dodge Road corridor (US-6), a higher emphasis is placed on expanding US-6 in the westbound (WB) direction to move traffic away from I-680 to minimize the potential for traffic to back onto I-680. A lesser emphasis is placed on expanding US-6 in the eastbound (EB) direction, which would likely result in pushing more traffic toward I-680.
- A *Highway Capacity Manual 2010 Edition* (HCM 2010) Level of Service (LOS) ‘D’ or better is desirable.
- Potential improvements with high costs or right-of-way impacts must show significant improvements in operations to be carried forward for consideration. In most cases, traffic operations would need to improve to LOS ‘C’. Some preliminary concepts were eliminated based on traffic operations criteria before further development of the concept.
- If desired LOS cannot be provided on both the mainline and adjacent collector-distributor (CD) road, traffic operations on the mainline is a higher priority than traffic operations on the CD road.
- Barriers that would restrict or redirect access to the freeway system from service interchanges during peak periods are not desirable because they also would restrict such access during off-peak periods when entering traffic is reduced and traffic operations are acceptable.
- Where partial cloverleaf (parclo) interchange configurations are preserved but impacted by mainline widening, existing loop ramp radii should be maintained if possible.
- Selective ramp metering may be employed to control the amount of traffic entering the freeway system, which may require that traffic use alternative routes or alternative interchanges.
- The closure of select service interchanges and/or service interchange ramps (permanent or peak-period only) may be employed to maintain freeway operations.
- Based on the study horizon traffic forecasts (year 2040), major system interchange improvements are not needed within the MTIS planning period.

### Methodologies

#### Roadway Methodology

Specific locations were particularly important in terms of providing proof of concept feasibility. In these locations, conceptual alignments and profiles were established and modeled for localized segments. This was generally limited to locations where interchange ramp modifications could create right-of-way impacts or a need to estimate the extent of mainline widening impacts on ramp alignment. Conceptual cross sections were extracted from the modeling and reviewed to check concept feasibility and to support determining whether a right-of-way impact would be necessary or could be avoided through application of retaining walls.

#### Bridge Methodology

Locations requiring bridge modifications were investigated and summarized. This effort captured the bridge location, expected bridge action (that is, replace, widen both sides, or widen one side), length of bridge improvements, width of bridge improvements, total area of bridge improvements, expected bridge type (for example, steel girder, prestressed girder, concrete slab), square foot unit cost, and total estimated bridge construction cost. Multipliers were developed to mitigate factors that may impact total construction cost, such as staging, work over railroad, and complex bridges (for example, curved, variable width). This effort also included a review to determine if complex phasing would be anticipated and/or if impacts to vertical clearances are expected (16’-6” vertical clearance desired, 16’-0” vertical clearance minimum for roadway over roadway bridges).

#### Utilities Methodology

Utility permits for utilities within interstate right-of-way were provided by NDOT. For areas within the study area but outside of the interstate right-of-way, the Study Team coordinated with utility companies and local governments to obtain locations of major utilities. Utilities included water main, sanitary sewer, storm sewer, fiber optics, electrical transformers, pipelines, and major electrical transmission lines.

#### Right-of-Way Methodology

Locations where the freeway concepts may require additional right-of-way were identified using the representative cross sections and based on a review of geographic information system (GIS) property/parcel data. Impacted properties were identified as a “partial take” or a “full take”.

#### Environmental Methodology

In MTIS Phase 2, natural and human environment resources in the Environmental Study Area (ESA) were identified. The ESA consisted of the existing right-of-way plus an additional 250 feet beyond the right-of-way for most resources. The exceptions were hazardous materials, which extended 0.10 mile beyond the right-of-way, and Section 4(f), which extended 0.25 miles beyond the right-of-way. The existing conditions for each resource were assessed to determine the presence of the resource and its general quality. The following resources were identified:

- Wetlands and waters of the US
- Threatened and endangered species
- Floodplains and water resources
- Hazardous materials
- Historical resources

- Section 4(f) and Section 6(f) resources
- Farmland
- Environmental justice
- Noise-sensitive receivers

In Phase 3, the potential impacts of the freeway concepts and sub-options on the environmental resources listed above were identified. Resources directly impacted by the project alternatives were quantified when possible, and in other instances, qualitative assessments were applied. The review was intended to identify potential fatal flaws or defensible reasons to reject specific actions and to identify issues warranting further environmental study during future project development phases. A matrix summarizing the potential impacts on relevant environmental resources can be found in **Appendix A**.

### **Traffic Methodology**

Additional traffic analysis and review was conducted in Phase 3 to aid in the identification of the recommended concept in each freeway corridor.

### **Updated Traffic Volumes and Forecasts**

Available traffic counts that have been collected by other agencies since the initial data collection task that occurred in 2014 were obtained from NDOT and the City of Omaha. These volumes were used to check if any freeway segments, system ramps, or ramp terminals experienced any significant traffic growth since the initial data collection effort. It was determined that for a majority of the locations, the traffic analysis did not need to be adjusted due to minor levels of growth.

One location, I-80 west of I-680, has experienced significant traffic growth at the Automatic Traffic Recorder (ATR) on I-80 between N-50 and Giles Road. Historical data were reviewed, and it was determined that mainline traffic volume adjustments were warranted. These adjustments were used in the traffic analysis that is discussed later in this chapter.

### **Origin-Destination Data**

Enhanced travel data were obtained from StreetLight Data, Inc. in Phase 3 for the I-80, I-680, and West Dodge Road corridors. These data included origin-destination data for estimating weaving volumes at spot locations and select-link data for estimating travel routes and paths. This type of data cannot be obtained or derived from traditional traffic volume counts and is critical for determining the appropriate lane configuration and the resulting weaving that could be expected with various improvement concepts. StreetLight develops these data from information created every second by mobile phones, GPS devices, connected vehicles, fitness trackers, and commercial fleet management systems as their users move. When these devices ping cell towers and satellites, they create records of the device's location. StreetLight transforms trillions of these anonymized records into useful travel information using proprietary algorithms (<https://www.streetlightdata.com>).

### **Traffic Volume Development**

Refined traffic volumes were developed for the specific purpose of evaluating the freeway improvement concepts. In Phase 2, the freeway concepts were evaluated using a single set of traffic forecasts that represented the Preferred Regional Strategy Package (Strategy Package 7) and relied on MAPA's travel demand model for weaving percentages or any origin-destination traffic data. In Phase 3, updated traffic volumes that are unique to each specific freeway concept were developed using a combination of travel demand modeling and manual reassignments, and using the origin-destination data obtained from StreetLight. A majority of these updates were focused on locations where CD roads

were introduced or new system interchange ramps were proposed. The updated volumes allowed the Study Team to analyze how much demand would shift to a CD road or a new system ramp if it were to be introduced.

### **Traffic Analysis**

Additional traffic analysis of each freeway corridor was conducted in Phase 3 to allow evaluation of the traffic service provided by the various concepts and sub-options. These analyses were conducted using both TransModeler (microsimulation) and the procedures from HCM 2010. TransModeler allowed the Study Team to analyze complex freeway geometries and interactions between system interchanges and closely spaced service interchanges. TransModeler also allowed the team to pinpoint potential localized congestion issues that may occur, and the potential upstream or downstream impacts of a concept or sub-option. Detailed traffic analysis findings can be found in the Phase 2 report and are summarized by corridor in **Chapter 3**.

The Study Team also conducted a "year of need" analysis for all freeway corridors to aid in the prioritization of freeway expansion projects. The year of need analysis consisted of estimating the year that a roadway segment will degrade from LOS 'D' to LOS 'E' operations. Analysis results for each expansion project can be found in the Project Sheets in **Chapter 4**.

### **Constructability Methodology**

The recommended concept for each freeway corridor is, in part, based on consideration of significant differences in the anticipated impacts on traffic operations between concepts or sub-options. Differences in the anticipated number of mainline traffic lanes that could be maintained during construction of a concept or sub-option, and locations of extended-duration lane or ramp closures were also considered. Comprehensive construction phasing concepts were not developed for the concepts and sub-options.

The narratives of recommended concepts for each freeway corridor in **Chapter 3** mention constructability findings, and constructability comments for individual projects can be found in the Project Sheets in **Chapter 4**.

### **Cost Estimates Methodology**

Conceptual-level construction and right-of-way cost estimates were developed for the individual proposed MTIS expansion projects for each freeway corridor, incorporating findings from the Phase 3 concept proofing. Project estimates were also developed for the system preservation projects in each corridor that were identified by NDOT. Where the MTIS expansion projects are proposed for implementation in conjunction with a system preservation project, the project cost estimates reflect a pavement methodology that combines the expansion widening with the system preservation work.

The components of the cost estimating approach are as follows:

- Development of mainline driving lane and shoulder pavement areas (square feet) for each proposed project, divided by 12-foot lane and shoulder widths, and converted to mileage to derive mainline lane-miles for each proposed project. Ramp lane and shoulder pavement areas estimated to need realignment or reconstruction for interchanges impacted by mainline widening, or to be reconfigured per the proposed expansion projects, were similarly quantified and converted to mileage to derive ramp lane miles for each affected interchange.
- Identification of relevant construction cost factors per lane-mile for mainline and ramp pavement, sub-base, grading and subgrade preparation, drainage elements, and miscellaneous other features, such as street lighting and signage from reasonably recent, similar freeway reconstruction and widening projects in the Omaha and Lincoln metropolitan areas (eight as-let projects considered).





- Identification of per-lane-mile cost factors for the following types of NDOT system preservation construction:
  - Minor system preservation (crack sealing, joint sealing and repair, and pavement panel repair)
  - Diamond grinding
  - First overlay
  - Second overlay
- For instances of expansion project widening in conjunction with system preservation work, development of adjustment factors for the mainline lane-mile cost factors based on number of adjacent lanes of widening and type of system preservation work.
- Identification of cost factors for the following expansion project features:
  - Bridge widening and replacement (per square foot of bridge deck)
  - Traffic signals (per location)
  - Walls – retaining and noise (per square foot of estimated exposed and buried face area)
  - Right-of-way acquisition (per NDOT-provided estimates for specific locations; otherwise, per square foot for assumed urban developed land)
- Calculation of construction and right-of-way costs for each MTIS expansion project and NDOT-identified system preservation project for the freeway corridors, applying the estimated mainline lane miles and adding in the interchange ramp lane miles and other expansion project features noted above, applying the developed cost factors. Costs for individual interchange modifications not associated with mainline expansion or system preservation were calculated in the same way, using the interchange ramp lengths and cost factors.

Construction cost estimates were independently developed by NDOT for nearly all of the proposed MTIS expansion projects. Although the level of estimating detail and the estimating approach were not made available, these estimates were compared against the Study Team developed estimates and for projects where the estimates had a significant variance. An effort was made to identify the cause for the variance and adjust the final estimate as appropriate.

As noted above, NDOT provided cost estimates for specific locations of right-of-way impact for many of the individual MTIS expansion projects. Where an NDOT estimate was not provided, a per-square-foot unit cost for developed urban land was applied to the estimated right-of-way impact area to generate a cost amount.

The cost factors used in developing the construction and right-of-way estimates for expansion and system preservation projects are shown in **Table 2.1**.

**Table 2.1. Unit Costs for Expansion and System Preservation Projects**

	Type	Cost	Unit
Expansion	New construction	\$ 1,100,000	12-foot-wide pavement lane per mile
	Bridge widening or replacement	\$ 155	Per square foot deck area
	Right-of-way	\$ 10	Per square foot
	Traffic signals	\$ 300,000	Per location
	Walls (noise / retaining)	\$ 65 / \$ 55	Per square foot
System Preservation	Minor system preservation*	\$ 4,000–\$ 23,000	12-foot-wide pavement lane per mile
	Diamond grinding	\$ 28,301	12-foot-wide pavement lane per mile
	First overlay	\$ 274,654	12-foot-wide pavement lane per mile
	Second overlay	\$ 212,683	12-foot-wide pavement lane per mile

\* Minor system preservation activities include crack sealing, joint sealing and repair, and panel repair.

## Chapter 3 - Corridor Summaries

This chapter presents the recommended concepts for each freeway corridor and notes the findings from the concept proofing process. Where deemed appropriate, it also summarizes comparative factors considered in evaluating the concepts. For the purposes of this report, concepts are defined as strategies applied to an entire corridor or substantial length of a corridor, while sub-options are defined as strategies applied to a specific area within a corridor.

### I-80 Corridor

The recommended concept and relevant findings from concept proofing for the I-80 corridor are described below, beginning at the west end. The recommended concept figures and typical sections are included in **Appendix B**. Considerations pertaining to roadway, bridge, and traffic operations, as well as the input provided by NDOT that affected the recommended concept, are also noted. No mainline operational needs were identified west of the N-31 interchange, so the discussion begins at the N-31 interchange.

#### N-31 Interchange

- A Diverging Diamond Interchange (DDI) is recommended at the N-31 interchange to accommodate future traffic volumes.
- The DDI could be constructed using the existing N-31 bridge over I-80.
- A retaining wall would likely be needed in the northeast quadrant of the interchange for the DDI conversion.
- The widening of N-31 north of I-80 to a six-lane section is recommended and was included in the Preferred Regional Strategy Package in Phase 2.
- Phase 2 also included a more detailed look at the potential traffic benefits (in terms of traffic diversion from existing interchanges) if a new interchange were to be built on I-80 in the vicinity of 186<sup>th</sup> Street. The analysis concluded that a DDI at the N-31 interchange and the widening of N-31 to the north of I-80 would not be needed if (1) a new interchange in the vicinity of 186<sup>th</sup> Street were to be constructed, and (2) capacity improvements were made to the east-west arterial network in the Gretna area, including Capehart Road and Schram Road.

#### I-80 Mainline, N-31 to N-370

- No mainline widening needs were identified as part of MTIS.

#### N-370 Interchange

- A DDI is recommended at the N-370 interchange to accommodate future traffic volumes regardless of whether or not a new interchange is constructed in the vicinity of 186<sup>th</sup> Street.
- The DDI could be constructed using the existing I-80 bridge over N-370.
- A two-lane entrance ramp to EB I-80 would be necessary to serve the high traffic volume on this ramp and to provide balanced lane utilization for EB N-370 traffic destined for EB I-80.
- NDOT considered constructing an EB N-370 to EB I-80 loop ramp as an interim project to address identified operational needs. However, the addition of a loop ramp alone would not provide an acceptable LOS throughout the interchange for year 2040 traffic volumes.
- The widening of N-370 to a six-lane section east and west of I-80 was included in the Preferred Regional Strategy Package in Phase 2 and is also included in the current list of Build Nebraska Act (BNA) projects.
- Additional right-of-way is not expected to be needed for the DDI conversion.

#### I-80 Mainline, N-370 to N-50

- For EB I-80, one additional mainline lane is needed between N-370 and N-50 to provide enough mainline lanes for a two-lane entrance ramp from N-370 to EB I-80. One entrance lane would add one basic lane that would be carried all the way to the I-80/I-680 system interchange. The other entrance lane would be an auxiliary lane that would extend to the N-50 interchange and be terminated with a two-lane exit ramp.
- No additional mainline lanes are recommended for WB I-80.

#### N-50 Interchange

- A DDI is recommended at the N-50 interchange to accommodate future traffic volumes.
- Due to the age of the existing bridge (S080 44066) and the need for additional lateral clearance for the I-80 recommended concept, new bridge(s) over I-80 would be constructed as part of the interchange reconfiguration. These bridges could be constructed off alignment for improved constructability and maintenance of traffic.
- The widening of N-50 north and south of I-80 to a six-lane section is recommended and was included in the Preferred Regional Strategy Package in Phase 2.

#### I-80 Mainline, N-50 to Giles Road

- Phase 2 identified the need for one additional basic lane (four lanes total) in each direction of I-80. However, NDOT requested that the section between N-50 and Giles Road also provide an additional auxiliary lane (five lanes total) between interchanges.
- The EB auxiliary lane would be terminated with a two-lane exit ramp at Giles Road.
- The WB auxiliary lane would be terminated with a two-lane exit ramp at N-50.
- The WB widening will impact the existing noise wall located along a short segment of residential parcels that abut I-80 to the north, approximately midway between N-50 and Giles Road, and will require acquisition of right-of-way.

#### Giles Road Interchange

- An expansion of the existing parcel configuration is recommended for the following reasons:
  - The City of La Vista recently completed a study for a future sports complex east of 120<sup>th</sup> Street. One recommendation from that study was that a two-lane entrance ramp be provided from northbound (NB) Giles Road to EB I-80. This would improve NB lane utilization on Giles Road approaching I-80. This ramp would taper to one lane before merging with EB I-80.
  - DDI options were considered. With a DDI, however, it would be undesirable to signalize the location where the dual right-turn lanes from NB Giles Road and the dual left-turn lanes from southbound (SB) Giles Road converge. Similarly, it would not be practical to provide these movements with their own lanes (four lanes total) before merging to a single lane prior to merging with EB I-80.
- Retaining walls may be needed along segments of the WB entrance ramp and the EB exit ramp to fit the adjusted ramp alignments through the existing right-of-way pinch points on the south and north sides of I-80 just west of Giles Road.
- The widening of Giles Road north and south of I-80 to a six-lane section is recommended and was included in the Preferred Regional Strategy Package in Phase 2.
- NDOT recommended adding an additional fourth SB lane on Giles Road from Harrison Street to the entrance ramp to WB I-80 to provide an outer bypass lane for vehicles destined for WB I-80 to get around queues extending back from the north ramp terminal intersection.

#### I-80 Mainline, Giles to ILQ

- For EB I-80, one additional mainline lane (five lanes total) is recommended between Giles Road and the I Street, L Street, and Q Street interchange area (ILQ).



- For WB I-80, two additional mainline lanes (five lanes total) are recommended between ILQ and Giles Road. One of the additional lanes would be a basic lane that would be carried all the way through the N-50 interchange. The other additional lane would be an auxiliary lane that would extend to the Giles Road interchange and be terminated with a two-lane exit ramp. This two-lane expansion may require significant fill, retaining walls, and drainage ramifications that will need to be investigated during project development.
- A retaining wall will be needed along the north side of I-80 where the widened WB lanes abut the Oak Hills Golf Course.

### ILQ Interchanges

- Due to the age of the existing bridges over I-80 at L Street (S080 44507 and S080 44508) and at I Street (S080 44537), and the need for additional mainline lanes and lateral clearance for the I-80 recommended concept, new two-span bridge(s) will be constructed at these locations.
- The only change required at the Q Street bridge over I-80 (S080 44459) to accommodate mainline expansion is replacement of the existing bridge abutment berm slopes with retaining walls to allow for the widening under the bridge. No changes are necessary to the existing Q Street interchange configuration to accommodate future traffic volumes.
- At L Street, a DDI is the recommended concept for the following reasons:
  - During full pavement replacement, constructing a majority of the DDI off alignment would provide major benefits from a constructability standpoint compared to rebuilding the full cloverleaf configuration. The bridges at L Street could be constructed off alignment for additional constructability and maintenance of traffic (MOT) benefits during the interchange reconfiguration.
  - From a traffic operations and safety perspective, a DDI reduces the amount of weaves and conflict points that exist in the current full cloverleaf configuration. Although there may be slightly more delay at the ramp terminals themselves with a DDI, other operational benefits on the CD road outweigh the additional delay at ramp terminals.
  - NDOT prefers to have a DDI interchange at this location.
- No changes are necessary to the existing I Street interchange configuration to accommodate future traffic volumes. The bridge at I Street will need to be replaced to accommodate additional mainline lanes and lateral clearance for the recommended concept.

### I-80 CD Road at ILQ

- NDOT wants to keep the EB CD road under L Street even though it would not be needed to serve future traffic volumes once a DDI is constructed at L Street. A minimum of two lanes on the CD road is recommended so that the CD road system could be used for traffic incident management (TIM), during bridge or pavement rehabilitation, or for other emergency situations. When the CD road is not in use for the above purposes, it could be gated similar to the existing NB I-680 CD road over West Center Road.
- The remainder of the CD road system would be similar to the existing configuration except for the weave areas that would be removed as part of the DDI reconfiguration of L Street.

### I-80 / I-680 System Interchange

- No changes to the configuration of the I-80 / I-680 system interchange are recommended.
- An increase in the number of lanes approaching the I-80 / I-680 system interchange or the number of lanes provided through the I-80 / I-680 system interchange is recommended at the following locations:
  - For the EB I-80 approach, one additional mainline lane (four lanes total) is recommended. These four lanes would split to two lanes to EB I-80 and two lanes to NB I-680. Lane balance would not be provided at this split.
  - For the WB I-80 approach, two additional mainline lanes (seven lanes total) are recommended. These seven lanes would split to three lanes to ILQ / West Center Road and five lanes continuing to the

I-80 / I-680 split. The five lanes would split to two lanes to WB I-80 and three lanes to NB I-680. Lane balance would not be provided at this split.

- For the SB I-680 approach, two additional mainline lanes (five lanes total) are recommended. These five lanes would split to three lanes to EB I-80 and two lanes to WB I-80. Lane balance would not be provided at this split.
- For the SB I-680 CD road approach, one additional lane (three lanes total) is recommended. These three lanes would split to two lanes to EB I-80 and two lanes to ILQ. The two lanes to EB I-80 would need to taper to one lane prior to merging with the two-lane ramp from the EB CD road (ILQ) to EB I-80. Multiple options for this merge were conceptually developed. NDOT preferred the option of using a 60:1 taper with a 12-foot-wide outside shoulder under the 108<sup>th</sup> Street bridge.
- NDOT does not have any major concerns with not providing lane balance at any of the locations noted above. However, special attention should be given to the signing layout due to the horizontal curvature of roadways within the interchange.

### I-80 Mainline, I-680 to 42<sup>nd</sup> Street

- Two concepts were developed and evaluated for the I-80 mainline.
- The first concept, referred to as the mainline widening concept, would add two additional basic lanes (six lanes total) and include auxiliary lanes between service interchanges (seven lanes total).
- The second concept would provide a CD road system from west of 84<sup>th</sup> Street to west of 42<sup>nd</sup> Street. Options for the number of lanes provided on the mainline versus the number of lanes provided on the CD road were evaluated. It was determined that providing three lanes on the mainline and three lanes plus auxiliary lanes on the CD road was operationally superior due the number of lane changes required for certain movements and the weaving sections created between the termini of the CD road system and the adjacent system interchanges.
- The mainline widening concept is recommended over the CD road system for the following reasons:
  - A CD road system does not offer significant operational advantages over the mainline widening concept. Additionally, there are significant unknowns and risks associated with the CD road system with respect to weaving operations between the termini of the CD road system and the adjacent system interchanges.
  - A schematic guide sign layout was developed for the CD road concept. Although adequate spacing exists to meet the requirements of the Manual of Uniform Traffic Control Devices (MUTCD), the CD road concept may be difficult to navigate for unfamiliar drivers who may wish to make fewer lane changes (as opposed to a typical everyday commuter).
  - At the CD road / mainline split at either end, lane balance cannot be provided.
  - During microsimulation analysis of the CD road concept, large vehicle queues were observed resulting from vehicles “setting themselves up” to make a weave maneuver between the CD road system and the adjacent system interchanges.
  - A CD road system would have higher costs and a larger footprint when compared to the mainline widening concept due to additional stormwater drainage elements and the dividing barriers that would be needed.
- Retaining walls will be needed at various locations. The locations identified through the process of localized concept -proofing are as follows:
  - Along the north side of the WB CD road in the vicinity of the 108<sup>th</sup> Street overpass.
  - Starting just west of 102<sup>nd</sup> Street to near 87<sup>th</sup> Street; in the vicinity of the EB 72<sup>nd</sup> Street ramp terminal; from near 61<sup>st</sup> Street to 60<sup>th</sup> Street; and from east of 52<sup>nd</sup> Street to approximately 42<sup>nd</sup> Street (Retaining walls may be needed at these locations in order to stay within the current right-of-way and easements with Union Pacific Railroad (UPRR) along the south side of I-80 and interchange ramps [as preferred by NDOT]).
  - Between EB I-80 and the D Street frontage road, beginning from just west of the Big Papillion Creek crossing to the end of the ramp taper for the EB exit ramp to 72<sup>nd</sup> Street.

- Along WB I-80 from the Little Papillion Creek crossing to the beginning of the ramp taper for the WB entrance ramp from 60<sup>th</sup> Street.
- Along WB I-80 west and east of the 50<sup>th</sup> Street underpass.
- Noise wall impacts (relocation / reconstruction) will occur along the WB exit ramp to 84<sup>th</sup> Street, east of the Big Papillion Creek.
- Additional right-of-way will be required at the following locations:
  - Approximately 12 residences between Nina Street and WB I-80, just east of the Big Papillion Creek crossing.
  - Partial acquisition of the Metro Self Storage Units property between the EB 84<sup>th</sup> Street entrance ramp and the Big Papillion Creek crossing.

### 84<sup>th</sup> Street, 72<sup>nd</sup> Street, and 60<sup>th</sup> Street Interchanges

- Phase 3 compared a DDI versus a parclo configuration for the 84<sup>th</sup> Street, 72<sup>nd</sup> Street, and 60<sup>th</sup> Street interchanges. The advantages and disadvantages of both configurations are summarized in **Table 3.1**.

**Table 3.1. Advantages and Disadvantages of Parclo and DDI Configurations**

	Parclo	DDI
Advantages	<ul style="list-style-type: none"> <li>• Splits entrance ramp traffic into two ramps (a loop ramp plus a diagonal ramp).</li> <li>• Ramp terminal LOS for parclo at all locations is slightly better than the DDI configuration based on volume of through traffic at each interchange.</li> <li>• City of Omaha cost share would be less than for a DDI.</li> </ul>	<ul style="list-style-type: none"> <li>• More evenly distributes traffic approaching each interchange across all lanes, allowing better lane utilization at upstream signals.</li> <li>• Offers potential safety benefits compared to a parclo.</li> <li>• Offers cost savings because the existing bridge width can be utilized for additional mainline lanes once the loop ramps are removed.</li> <li>• Is more ramp-meter friendly.</li> <li>• Is unlikely to require new right-of-way.</li> </ul>
Disadvantages	<ul style="list-style-type: none"> <li>• Requires that all traffic destined for either direction of I-80 be in the right-most lane, resulting in long queues on some approaches.</li> <li>• Offers fewer potential safety benefits compared to a DDI.</li> <li>• Will require more bridge widening to accommodate additional mainline lanes.</li> <li>• Is not as ramp-meter friendly.</li> <li>• May require additional right-of-way.</li> </ul>	<ul style="list-style-type: none"> <li>• Single ramp must serve all of the entrance ramp traffic. This may be a problem for 72<sup>nd</sup> Street traffic destined for WB I-80.</li> <li>• City of Omaha cost share would be more than for a parclo.</li> <li>• Ramp terminal LOS for DDI at all locations is slightly worse than the parclo configuration based on volume of through traffic at each interchange.</li> </ul>

- Based on **Table 3.1** and input from NDOT and the City of Omaha, a parclo configuration is recommended at the 84<sup>th</sup> Street, 72<sup>nd</sup> Street, and 60<sup>th</sup> Street interchanges.
- Reconstruction of the ramp tapers and gore areas for all of the existing diagonal entrance and exit ramps and the loop entrance ramps will be necessary to accommodate the added mainline lanes on I-80. At the 84<sup>th</sup> Street interchange, reconstruction of the entire WB diagonal entrance, WB loop entrance, WB exit, EB loop entrance, and EB diagonal entrance ramps are anticipated. A retaining wall may be needed between the WB exit ramp and the WB loop entrance ramp. At the 72<sup>nd</sup> Street interchange, ramps expected to require reconstruction are the WB exit, the WB loop entrance, the EB loop entrance, and the EB diagonal entrance. The 60<sup>th</sup> Street interchange ramps anticipated to require reconstruction are the WB loop and diagonal entrances, and the ramps anticipated to require partial reconstruction are the WB exit ramp, the EB exit ramp, and the EB loop ramp and diagonal entrance ramps.
- The widening of 72<sup>nd</sup> Street south of I-80 to a six-lane section is recommended and was included in the Preferred Regional Strategy Package in Phase 2.

### 42<sup>nd</sup> Street Interchange

- Phase 3 also compared a DDI and a parclo configuration for the 42<sup>nd</sup> Street interchange. The advantages and disadvantages summarized in **Table 3.1** apply to this location as well.
- NDOT has concerns about the proximity of the 42<sup>nd</sup> Street interchange to the I-480 / US-75 system interchange and the weaving conditions that may result. NDOT would prefer that all of the traffic entering EB I-80 not be served by a single diagonal ramp because this would shorten the weaving distance for traffic from SB 42<sup>nd</sup> Street to EB I-80.
- The closure of some or all of the ramps at 42<sup>nd</sup> Street was considered. However, previous commitments from NDOT to retain this interchange, given its importance to the University of Nebraska Medical Center (UNMC) to the north and the industrial areas to the south, led to the elimination of this option.
- Based on the above and input from the City of Omaha, a parclo configuration is recommended at 42<sup>nd</sup> Street.
- To accommodate the six mainline lanes needed for EB I-80 through the 42<sup>nd</sup> Street interchange (see next section), the SB 42<sup>nd</sup> Street to EB I-80 loop entrance ramp would be modified to allow it to merge onto the EB I-80 mainline (rather than adding a lane). The NB 42<sup>nd</sup> Street to EB I-80 ramp would also merge onto the EB I-80 mainline.
- Widening of the I-80 mainline and the ramp alignment modifications noted above will necessitate reconstruction of ramp tapers and gore areas for all of the interchange ramps, and reconstruction of the EB exit and EB loop entrance, and the WB loop entrance ramps. Partial reconstruction of the WB exit and EB diagonal entrance ramps is anticipated.

### I-80 Mainline, 42<sup>nd</sup> to I-480 / US-75 System Interchange

- For EB I-80, six basic lanes over 42<sup>nd</sup> Street are recommended to avoid significant congestion in year 2040 during the AM and PM peak periods. As noted in the previous section, the parclo interchange at 42<sup>nd</sup> Street would be modified such that six lanes would be provided on the EB I-80 approach to the I-80 / I-480 / US-75 system interchange (as is provided today). From an operational perspective, providing seven lanes on the EB I-80 approach to the I-80 / I-480 / US-75 system interchange would be preferred. However, the drawbacks to this include the following:
  - No lane balance would be provided at the NB I-480/SB US-75 split.
  - Adding a seventh lane between 42<sup>nd</sup> Street and I-480 would impact a building on the National By Products property just west of the I-80 bridge over 32<sup>nd</sup> Avenue (S080 45252).
  - NDOT has right-of-way and easement concerns regarding the adjacent UPRR tracks in this area. A retaining wall is likely to be necessary between EB I-80 and the UPRR right-of-way from 42<sup>nd</sup> Street to about 36<sup>th</sup> Street.
- For WB I-80, one additional lane (eight lanes total) is recommended between the I-80 / I-480 / US-75 system interchange and 42<sup>nd</sup> Street to accommodate the second lane that is recommended for the NB US-75 flyover ramp to WB I-80. The additional WB I-80 lane would be dropped with a two-lane exit to 42<sup>nd</sup> Street. The following two options were considered to avoid carrying eight lanes to 42<sup>nd</sup> Street but were eliminated:
  - Provide a dynamic/managed interior lane merge for the merge of the NB US-75 to WB I-80 movement with the SB I-480 to WB I-80 movement. However, NDOT did not support this option.
  - Taper out the eighth WB I-80 lane prior to 42<sup>nd</sup> Street. During microsimulation analysis, this was observed to result in major backups on the NB US-75 flyover ramp to WB I-80.



### I-80 / I-480 / US-75 System Interchange

- No changes to the configuration of the I-80 / I-480 / US-75 system interchange are recommended.
- An increase in the number of lanes approaching the I-80 / I-480 / US-75 system interchange or the number of lanes provided through the I-80 / I-480 / US-75 system interchange is recommended at the following locations:
  - For the SB I-480 approach, one additional mainline lane (five lanes total) is recommended. These five lanes would split to three lanes to WB I-80 and three lanes to the EB I-80 / SB US-75 split. At this split, two lanes would be provided to SB US-75 and one lane would be provided to EB I-80. Lane balance would not be provided at this split.
  - For the NB US-75 approach, one additional mainline lane (five lanes total) is recommended. These five lanes would split to two lanes to EB I-80 and four lanes to the WB I-80 / NB I-480 split. At this split, two lanes would be provided to WB I-80 and two lanes would be provided to NB I-480. Lane balance would not be provided at this split.

### I-80 Mainline, I-480 / US-75 System Interchange to Missouri River

- This section of I-80 is currently being expanded to match the Iowa Department of Transportation's Council Bluffs Interstate System improvements. The mainline expansion as part of this project will accommodate year 2040 traffic volumes.
- This expansion includes a short stretch of I-80 that will require shoulder exceptions to allow three lanes in each direction near the 24<sup>th</sup> Street bridge over I-80.

### 24<sup>th</sup> Street Interchange

- NDOT's long-term vision is to remove the 24<sup>th</sup> Street ramps for the following reasons:
  - Removal of the 24<sup>th</sup> Street ramps would allow 12-foot-wide shoulders to be constructed in the area of the shoulder exceptions noted above.
  - The interchange is currently configured as a half interchange with no future plans by NDOT to make it a full interchange.
  - Current peak hour ramp volumes are relatively low.
  - A road diet (conversion of the existing four-lane section to a three-lane section) on 24<sup>th</sup> Street is included in MAPA's TIP.

### 13<sup>th</sup> Street Interchange

- The 13<sup>th</sup> Street interchange is currently being modified to match the Council Bluffs Interstate System improvements. This project will accommodate year 2040 traffic volumes.

### Summary of I-80 Concepts and Sub-Options

The concepts and sub-options considered for the I-80 corridor during Phase 3 are summarized in **Table 3.2**.

**Table 3.2. Summary of I-80 Concepts and Sub-Options**

I-80			
Concept	Name	Description	Phase 3 Decision
1	Mainline Widening	Addition of 1 or 2 mainline lanes plus auxiliary lanes depending on location. DDIs at N-31, N-370, N-50.	Selected
2	Collector-Distributor System	Equal to Concept 1 except CD road section instead of additional mainline lanes from west of 84 <sup>th</sup> Street to west of 42 <sup>nd</sup> Street. Inside = 3 lanes, Outside = 3 lanes + auxiliary lanes.	Not Selected – Uncertainty regarding traffic operations at CD road origin/terminus and additional right-of-way impacts
<b>Sub-Option</b>			
A	8-lane Widening WB from US-75 to 42 <sup>nd</sup> Street; 7-lane Widening over 42 <sup>nd</sup> Street (EB/WB)	Widen WB I-80 to 8 lanes from US-75 with 7 lanes over 42 <sup>nd</sup> Street. Widen EB I-80 to 7 lanes over 42 <sup>nd</sup> Street.	WB: Selected EB: Not Selected – Additional lane changes required for 42 <sup>nd</sup> Street to EB I-80 traffic and additional right-of-way impacts
B	EB I-80 5-lane Diverge to I-480 / US-75	7 lanes to 3 lanes and 5 lanes at I-80 / I-480 diverge. 5 lanes to 3 lanes and 2 lanes at I-480 / US-75 diverge.	Not Selected – Additional lane changes required for 42 <sup>nd</sup> Street to EB I-80 traffic and additional right-of-way impacts
C	SB I-480 / NB US-75 Dynamic Merge to WB I-80	Interior merge with dynamic lane assignment.	Not Selected – Uncertainty of interior merge operations resulting from non-compliant users
D	Ramp Closures	Permanently close 42 <sup>nd</sup> Street ramps to/from the east and/or 24 <sup>th</sup> Street ramps to/from the west.	42 <sup>nd</sup> Street: Not Selected – Not supported by Stakeholder Committee 24 <sup>th</sup> Street: Selected – Identified by NDOT as part of its long-term vision
E	Ramp Metering	Candidate locations (AM & PM): All entrance ramps at 84 <sup>th</sup> Street, 72 <sup>nd</sup> Street, 60 <sup>th</sup> Street, and 42 <sup>nd</sup> Street.	Retained for further consideration
F	Additional DDI Interchanges	DDIs at Giles Road, L Street, 84 <sup>th</sup> Street, 72 <sup>nd</sup> Street, 60 <sup>th</sup> Street, and 42 <sup>nd</sup> Street.	L Street: Selected Giles Road, 84 <sup>th</sup> Street, 72 <sup>nd</sup> Street, 60 <sup>th</sup> Street, and 42 <sup>nd</sup> Street: Not Selected – No significant mainline operations advantage for DDI versus parclo.

## I-480 Corridor

The recommended concept and relevant findings from concept proofing for the I-480 corridor are described below, beginning at the north end. The recommended concept figures and typical sections are included in **Appendix C**. Considerations pertaining to roadway, bridge, and traffic operations, as well as the input provided by NDOT that affected the recommended concept, are also noted. No mainline operational needs exist on the east-west portion of I-480, so the discussion begins at the I-480 / US-75 system interchange (including the Cuming Street and Hamilton Street ramps to the south).

### I-480 / North Freeway (US-75) System Interchange

- The existing system interchange configuration is recommended at the I-480 / North Freeway system interchange.
- The Study Team looked at potential options to remove the left-hand merge from Cuming Street to SB I-480. The current configuration does not have an operational issue, but NDOT has concerns over the speed differential with heavy trucks. The entrance ramp has a significant upgrade that does not allow heavy trucks to reach freeway speeds before they need to merge. The following options would mitigate this issue:
  - Cuming Street entrance ramp lane addition instead of merge: This option would add a lane with the Cuming Street entrance ramp to SB US-75. This option was removed because it has adverse impacts downstream. It would require a lane drop from five lanes to four before the Harney Street entrance ramp and the replacement of the Harney and Farnam Street bridges.
  - Cuming Street entrance ramp lane addition with SB US-75 taper: This option would add a lane with the Cuming Street entrance ramp to SB US-75, followed by a right-hand lane drop before SB US-75 connects with SB I-480. This option was removed because it effectively reduces US-75 to one lane. This lane configuration is not consistent with the traffic volumes for SB US-75 and Cuming Street to SB I-480.
- The Study Team reviewed the potential reconfiguration of the 30<sup>th</sup> Street ramps on the west side of the system interchange. Due to a potential new development on the east side of 30<sup>th</sup> Street and north of Dodge Street, it is possible that the 30<sup>th</sup> Street to SB I-480 ramp would be removed. If that were to happen, it was determined that a two-lane entrance ramp from Harney Street would need to be provided to accommodate traffic diverted from 30<sup>th</sup> Street. Because this development is in early planning stages, MTIS recommends that the existing ramp reconfiguration be retained until more information is available.
- The weave between NB I-480 to NB North Freeway and WB I-480 to NB North Freeway may become an issue by year 2040. It is important to note that the higher volume movement (NB I-480 to NB North Freeway) has a lane that drops at Hamilton Street. There is the potential to taper the WB I-480 to NB North Freeway movement to one lane and change the NB exit ramp at Hamilton Street to a single-lane diverge.

### I-480 Mainline, North Freeway to Farnam Street / Harney Street Interchange Ramps

- No NB mainline widening needs were identified as part of MTIS.
- An additional SB mainline lane is recommended just north of the SB Harney Street entrance ramp to remove the existing lane drop.

### Farnam Street / Harney Street Interchange

- An additional SB entrance ramp lane that tapers back to one lane before connecting with the SB I-480 mainline is recommended to relieve some of the localized congestion along Farman and 29<sup>th</sup> Streets during the PM peak hour.
- The City of Omaha expressed concerns over the ramp terminal operations at Harney and Farnam Streets during Phase 2. The addition of a second (choice) entrance ramp lane to better distribute volume on 29<sup>th</sup> Street, as well as improved signal timing, addresses this issue.

### I-480 Mainline, Farnam Street / Harney Street to Leavenworth Street / St. Mary's Avenue Ramps

- No NB mainline widening needs were identified as part of MTIS. It is anticipated that the NB mainline section will operate at LOS 'E' during the AM peak hour in year 2040. The Study Team reviewed the option to provide a five-lane section, but lane balance would not be maintained at the NB Farnam / Harney Street exit ramp. NDOT ultimately chose the option that provides lane balance and that will occasionally have minor slowdowns during the AM peak hour.
- The SB Farnam Street / Harney Street entrance ramp will become the fifth basic lane that is carried all the way to the WB I-80 / SB US-75 split.
- The need for the reconstruction and widening of I-480 will require replacement of structures crossing over I-480 with insufficient horizontal clearance for the improvements. Bridges that cross over I-480 at St. Mary's Avenue, Leavenworth Street, and Woolworth Avenue will be replaced.
- The SB widening of I-480 may require retaining walls through this segment.

### Leavenworth Street / St. Mary's Avenue Interchange

- No interchange needs were identified as part of MTIS.
- To maintain lane balance, a two-lane NB exit ramp is recommended at the Leavenworth Street / St. Mary's Avenue interchange.

### I-480 Mainline, Leavenworth Street / St. Mary's Avenue to Martha Street

- An additional lane in both directions (five lanes total) is recommended.
- Between Leavenworth Street and Martha Street, I-480 has horizontal curves within its existing alignment while local roads (28<sup>th</sup> Street and 29<sup>th</sup> Street) that border I-480 do not have curves in the alignment. Early in the study, an effort was made to straighten the I-480 alignment. However, the concept proofing task for this segment revealed that removing the curves resulted in the need for much higher retaining walls, as high as 23 feet on the west side near Woolworth Avenue. This analysis resulted in keeping the horizontal alignment in its current location.
- The widening of both NB and SB lanes through this depressed segment of I-480 may require retaining walls on both sides of the alignment.

### Martha Street Interchange

- No interchange needs were identified as part of MTIS.
- The NB exit ramp changes from a two-lane exit ramp (with lane balance) to a single-lane diverge to allow for the recommended number of NB mainline lanes through the interchange.
- Retaining walls may be required from the Martha Street bridge to the NB entrance ramp.

### I-480 Mainline, Martha Street to I-80

- No NB mainline widening needs were identified as part of MTIS. Currently, the right-most lane is underutilized because it drops at the NB Martha Street exit ramp. Once the NB Martha Street exit ramp is modified to a single-lane diverge, lane use will be improved across the three-lane ramp from EB I-80 to NB I-480, which will improve NB operations from I-80 to Martha Street.
- An additional SB lane will continue through the SB I-480 to WB I-80 ramp while providing lane balance. This results in a SB three-lane section after the SB I-480 to WB I-80 ramp. The right-most lane will drop at the "to EB I-80" system ramp. A closely spaced pier at the Vinton Street Bridge (S480 00022) may require the SB three-lane section to have a shoulder exception.
- The additional lane added to SB I-480 may require retaining walls to avoid right-of-way impacts on residences that border the west side of the corridor.



### Summary of I-480 Concepts and Sub-Options

The concepts and sub-options considered for the I-480 corridor during Phase 3 are summarized in **Table 3.3**.

**Table 3.3. Summary of I-480 Concepts and Sub-Options**

I-480			
Concept	Name	Description	Phase 3 Decision
1	Mainline Widening	Addition of 1 mainline lane.	Selected
<b>Sub-Option</b>			
A	Martha Street Ramp Closure	Permanently close Martha Street ramps to/from the south.	Not Selected – Not supported by Stakeholder Committee
B	Ramp Metering	Candidate locations: AM: NB entrance ramp at Martha Street. PM: SB entrance ramps at Cuming Street, 30 <sup>th</sup> Street, Harney Street, Leavenworth Street, and Martha Street.	Retained for further consideration

### I-680 Corridor

The recommended concept and relevant findings from concept proofing for the I-680 corridor are described below, beginning at the north end. The recommended concept figures and typical sections are included in **Appendix D**. Considerations pertaining to roadway, bridge, and traffic operations, as well as the input provided by NDOT that affected the recommended concept, are also noted. No mainline operational needs exist east of Blair High Road (N-133), so the discussion begins at the Blair High Road interchange.

#### Blair High Road and Fort Street Interchanges

- An Interchange Justification Report (IJR) was completed in 2013 for the Fort Street and Blair High Road interchanges. The recommendations from the IJR were used as the I-680 recommended concept for MTIS. Per NDOT's direction, no other concepts were considered for these interchanges as part of MTIS.
- At the Fort Street interchange, the EB Fort Street to NB (EB) I-680 loop will not be constructed as part of the initial improvements, but the NB (EB) exit ramp will be offset for future expansion. For purposes of showing the recommended concept, the loop ramp was assumed to be constructed and is shown in **Appendix D**.

#### I-680 Mainline, Blair High Road to West Maple Road

- As part of the IJR, mainline improvements (one additional basic lane with auxiliary lanes between interchanges) were also recommended. The recommendations from the IJR were used as the I-680 recommended concept for MTIS. Per NDOT's direction, no other mainline capacity concepts were considered as part of MTIS.
- Due to the age of the existing bridge structures (S680 00604L and S680 00604R) and the need for additional mainline lanes, new bridges will be constructed as part of the recommended concept at Fort Street.

#### West Maple Road Interchange

- NDOT recommended a SB two-lane exit ramp at West Maple Road, the WB West Maple Road to SB I-680 loop adding a fourth lane to SB I-680, and the EB West Maple Road to SB I-680 ramp adding the fifth lane to SB I-680. The three-lane basic freeway section that results from the SB two-lane exit ramp between the SB exit ramp and the loop ramp will operate at a high LOS 'D' in year 2040.
- NDOT recommended retention of the existing NB I-680 configuration north of the NB exit ramp through the West Maple Road interchange. The three-lane basic freeway section between the NB exit ramp and the loop ramp will operate at a high LOS 'D' in year 2040.

#### I-680 Mainline, West Maple Road to West Dodge Road (US-6)

- One additional basic lane (five lanes total) is recommended in both directions between West Maple Road and West Dodge Road.
- NB mainline considerations include the following:
  - Due to the NDOT recommendations at the West Maple Road interchange, NB I-680 approaching West Maple Road will not provide lane balance in the recommended concept. This would result in a two-lane entrance ramp from West Dodge Road followed by a two-lane exit ramp at West Maple Road with no lane balance.
  - The Study Team elected to modify the Phase 2 concept by increasing the NB weaving distance between West Dodge Road and West Maple Road. This is achieved by staggering the entrance ramps at West Dodge Road instead of adding them as a two-lane entrance ramp to NB I-680. The WB West Dodge Road to NB I-680 ramp would be added approximately 1,500 feet south of its current location, and the EB West Dodge Road to NB I-680 ramp would be added near the location where the West Dodge Road ramps enter NB I-680 today.

- SB mainline considerations include the following:
  - SB I-680 approaching the I-680 / West Dodge Road split will not provide lane balance in the recommended concept.
  - The Study Team considered providing lane balance at the West Dodge Road / I-680 split with a five to three and three split, but this option was removed for the following reasons:
    - The exit ramp volume to West Dodge Road does not require three lanes from a capacity standpoint.
    - Providing a three-lane exit ramp to West Dodge Road does not provide a significant operational advantage. It does not change the number of lane changes that West Maple Road users need to make to continue on SB I-680.
    - The successive lane drops required with a three-lane exit ramp would be tightly spaced, and all would not provide lane balance.

### ***I-680 / West Dodge Road (US-6) System Interchange***

- SB I-680 needs were identified in Phase 2 at the WB West Dodge Road to SB I-680 merge.
- NDOT does not support a dynamic merge option (Phase 2 Sub-Option A). Another potential option would be to ramp meter the WB West Dodge Road to SB I-680 loop ramp to improve the merge. Ramp metering is discussed in detail in the Other Strategy Considerations section later in this chapter.
- The West Dodge Road ramps to and from the west are discussed in detail in the West Dodge Road section.

### ***I-680 Mainline, West Dodge Road (US-6) to Pacific Street***

- SB mainline considerations include the following:
  - NDOT directed the Study Team to provide six lanes under Pacific Street if the system ramp from EB West Dodge Road was expanded to three lanes. Through microsimulation, it was determined that providing six SB lanes under Pacific Street would cause a bottleneck at the weave between Pacific Street and the West Center Road / ILQ CD road.
  - Based on the freeway system priorities that were established, NDOT would prefer to have localized congestion on West Dodge Road ramps instead of the I-680 mainline. Therefore, the recommended concept retains the two-lane ramp section of the EB West Dodge Road to SB I-680 ramp. This concept would keep the existing SB number of lanes (five lanes total) but would provide better lane utilization from the expansion to five lanes under Pacific Street.
- NB mainline considerations include the following:
  - NDOT did not support the expansion of the I-680 CD road system between I-80 and West Dodge Road. NDOT did not want to restrict traffic from making a standard freeway movement during off-peak hours. It was determined that mainline widening (without CD roads) would be the recommended concept for this section of I-680.
  - The Study Team considered providing six lanes under Pacific Street to improve NB throughput and travel speeds. Through microsimulation, it was determined that there was minimal difference between the expansion to five or six lanes under Pacific Street. The six-lane concept under Pacific Street would improve speeds slightly during the peak hour, but has a few drawbacks, including the additional cost. Additional considerations are as follows:
    - The six-lane concept would require users on the NB Pacific Street entrance ramp to make an additional lane change to continue on NB I-680.
    - The six-lane concept would also reduce the NB Pacific Street exit ramp to a single-lane diverge. This exit ramp is heavily used during both peak hours and would not operate as well as a two-lane ramp.

### ***Pacific Street Interchange***

- NDOT supported the sub-option that removed the Pacific Street ramps to the north to improve mainline operations due to the proximity of the Pacific Street interchange to the West Dodge Road system interchange ramps. However, the Stakeholder Committee was generally opposed to closing the Pacific Street ramps. It was determined that the removal of the Pacific Street ramps would not be included in the recommended concept.
- The existing diamond configuration at Pacific Street does not provide acceptable LOS in the year 2040. NDOT recommended that any concepts developed should minimize the impacts on the recently constructed (2008) bridge. It was determined that a DDI would be able to provide acceptable LOS. It is anticipated that there will be a cost-share component of the DDI reconfiguration between NDOT and the City of Omaha.
- A concept proofing exercise was undertaken to determine if the existing Pacific Street bridge over I-680 has enough horizontal clearance to accommodate six lanes in each direction under the structure. The exercise showed that there is sufficient distance to accommodate the 12-lane section; however, shoulder widths would be substandard. No stopping sight distance issues were discovered. It was also determined that the structure would not require widening to accommodate the reconfiguration of the Pacific Street diamond interchange to a DDI.

### ***I-680 Mainline, Pacific Street to I-80***

- Two options were considered to improve operations between Pacific Street and I-80: (1) mainline widening and (2) expansion of the CD road system.
- NDOT did not support expansion of the CD road system in the NB or SB direction for the following reasons:
  - NDOT did not want to restrict traffic from making a standard freeway movement and force traffic to a CD road during off-peak hours.
  - The CD road concept has a larger footprint and has potential right-of-way impacts between Pacific Street and West Center Road.
  - The CD road concept has higher construction costs.
- The Study Team noted in Phase 2 that the CD road option provided better mainline operations and improved travel speeds when compared to the mainline widening concept. This is mostly due to the removal of LOS 'F' weave locations between Pacific Street and West Center Road.
- It was determined that the mainline widening concept would be the recommended concept for the remainder of the concept proofing task due to the support of NDOT and the cost savings of the mainline widening concept compared to the CD road concept (~\$12 Million [M]).
- The recommended concept option would provide the following expansions to the mainline:
  - NB: Two additional through lanes from I-80 to West Center Road (six lanes total)
  - NB: One additional lane from West Center Road to Pacific Street (six lanes total)
  - SB: One additional lane from Pacific Street to the West Center Road / ILQ CD road ramp (six lanes total)
  - SB: One additional lane from the West Center Road / ILQ CD road ramp to the West Center Road bridge (five lanes total)
  - SB: Two additional lanes from the West Center Road bridge to I-80 EB/WB split (five lanes total)
- The recommended concept will require the replacement of the CD road bridges (S680 00083A and S680 00083B) over West Center Road to allow enough lateral clearance to fit the recommended number of mainline lanes. Additional considerations are as follows:
  - The SB bridge will be constructed off alignment before the SB mainline expansion for constructability and maintenance of traffic benefits during the expansion.
  - The NB bridge serves only the loop ramp to WB West Center Road, so it can be reconstructed on or off alignment with minimal impacts on traffic. Reconstruction on alignment is shown in the concept figures in **Appendix D**. The widening of NB I-680 may require both retaining walls and right-of-way acquisitions from, and including, the West Center Road entrance ramp to, and including, the Pacific Street exit ramp.





### I-680 / I-80 CD Roads, West Center Road to I-80

- The existing CD road configuration will be incorporated into the recommended mainline widening concept.
- The SB CD road section between the West Center Road entrance ramp and the CD road split to I-80 EB/WB will have a LOS 'F' weave during the peak hours if the existing configuration is used as the recommended concept. These backups could potentially spill back onto SB I-680 during AM and PM peak periods.
- The Study Team considered moving the West Center Road entrance ramp to enter the CD road on the left side to help with the weave. This option removed the LOS 'F' weave because a majority of the users from West Center Road are destined for EB I-80. Putting users on the left side of the CD road as a lane add effectively reduced the weaving volume from 75 to 25 percent in that section of roadway. The following two options could accomplish this:
  - Option 1: Shift the CD road to the west and provide a SB single-lane diverge to West Center Road directly off of SB I-680. This exit ramp would align with the West Center Road to SB CD road entrance ramp that would enter as a lane add on the left side of the CD road.
  - Option 2: Shift the CD road to the west and provide a left-hand exit off the CD road to West Center Road. The left-hand exit ramp would align with the West Center Road to SB CD road entrance ramp that would enter as a lane add on the left side of the CD road.
- Both of these options greatly improve the problem weaving segment noted. During the study, NDOT expressed concern over having the West Center Road exit ramp (Option 1) exit directly from I-680 instead of the CD road. Based on this concern, the Study Team selected Option 2 for the recommended concept.
- Retaining walls may be needed for the CD road just north of the split for the West Center Road exit ramp to avoid right-of-way impacts on homes. Noise walls are already provided in this segment.

### West Center Road Interchange

- The existing configuration is expected to provide acceptable LOS in year 2040. The change to the recommended location of the CD road and the SB exit ramp from the CD road, mentioned above, will not adversely impact the LOS of the West Center Road interchange.

### Summary of I-680 Concepts and Sub-Options

The concepts and sub-options considered for the I-680 corridor during Phase 3 are summarized in **Table 3.4**.

**Table 3.4. Summary of I-680 Concepts and Sub-Options**

I-680			
Concept	Name	Description	Phase 3 Decision
1	Mainline Widening	Addition of 1 or 2 mainline lanes. Follows NDOT's IJR recommendation from West Maple Road through Blair High Road (with parclos at Fort Street and Blair High Road). DDI at Pacific Street.	Selected
2	Mainline Widening plus Expanded CD Road	Reconfiguration of CD road from I-80 to Pacific Street.	Not Selected – NDOT decision to avoid full-time restriction on traffic movements to the CD road and additional right-of-way impacts
<b>Sub-Option</b>			
A	SB I-680 Dynamic Merge at West Dodge Road	Improve PM merge operations by shifting I-680 SB traffic to left 2 lanes to provide gaps for merging traffic through Dynamic Message Signs.	Not Selected – Uncertainty of effectiveness resulting from non-compliant users
B	Pacific Street Ramp Closure	Permanently close Pacific Street ramps to/from the north.	Not Selected – Not supported by Stakeholder Committee
C	Ramp Metering	Candidate locations: AM & PM: All entrance ramps at West Center Road and Pacific Street. AM Only: Potentially WB West Dodge Road to I-680 SB.	Retained for further consideration

### US-75 (Kennedy Freeway) Corridor

The recommended concept and relevant findings from concept proofing for the US-75 corridor are described below, beginning at the north end. The recommended concept figures and typical sections are included in **Appendix E**.

Considerations pertaining to roadway, bridge, and traffic operations, as well as the input provided by NDOT that affected the recommended concept, are also noted. No mainline operational needs exist on the North Freeway (Ames Avenue to Hamilton Street) or south of N-370, so the discussion begins at the I-80 / I-480 / US-75 system interchange and ends at the N-370 interchange.

### I-80 / I-480 / US-75 System Interchange

- No changes to the configuration of the I-80 / I-480 / US-75 system interchange are recommended.
- For the NB US-75 approach, one additional mainline lane (five lanes total) is recommended. These five lanes would split to two lanes to EB I-80 and four lanes to the WB I-80/NB I-480 split. At this split, two lanes would be provided to WB I-80 and two lanes would be provided to NB I-480. Lane balance would not be provided at this split. For the flyover to WB I-80, two lanes would be provided without widening the existing structure (S080 45308). This would result in a typical section of two 12-foot-wide lanes with 6-foot-wide shoulders (inside and outside).
- The NB widening may require minor right-of-way acquisitions and retaining walls along US-75 between E Street and C Street.
- The following two options were considered for the NB US-75 approach but were ultimately dropped from consideration:
  - Add one NB lane to the approach (four lanes total) to the I-80 EB split with two lanes to I-80 (existing) and three lanes to I-80 WB and I-480 (existing). The three lanes would split with two lanes to I-480 and two lanes to WB I-80 (existing). This option was originally preferred by NDOT because it provided lane balance at the WB I-80 / NB I-480 split but was later dropped due to unacceptable future traffic operations.
  - Provide a new CD road split approaching the interchange where four lanes would split three lanes on the outside to I-80 and two lanes to I-480. The three lanes to I-80 would split with two lanes to EB I-80 and two lanes to WB I-80. This concept provides acceptable traffic operations but also requires the reconstruction of the WB I-80 flyover and would require some additional right-of-way on the east side of the interchange. Because of the additional bridge and right-of-way costs for this option, it was dropped from consideration.

### F Street Interchange

- The Study Team investigated multiple options to keep the F Street interchange open, but the closure of the F Street interchange is recommended for the following reasons:
  - The interchange is close to the I-80 / I-480 / US-75 system interchange.
  - Current peak hour volumes are relatively low, with minimal growth expected in the area.
  - The interchange does not fit with the proposed mainline recommendations.
- The following options were investigated to keep the F Street Interchange open:
  - Tapering in the NB entrance ramp, followed by a two-lane exit ramp (with lane balance) to EB I-80. The interchange spacing was too close to provide adequate taper distances.
  - Adding the NB entrance ramp, followed by a two-lane exit ramp (without lane balance) to EB I-80.
- With the closure of the F Street interchange, improvements to Dahlman Avenue are recommended to provide truck access to US-75 via the L Street interchange. This includes the replacement of the rail bridge (U1825D5305) near the H Street intersection to improve both vertical and horizontal clearances.

### **US-75 Mainline, I-80 to L Street**

- Five lanes are recommended on the US-75 mainline between L Street and I-80.
- NB mainline considerations include the following:
  - The L Street entrance ramp would add one mainline lane (five lanes total). These five lanes would split to four and two at the ramp to EB I-80 (with lane balance). The remaining four mainline lanes would split to two and two at the NB I-480 and WB I-80 split. Lane balance would not be provided at this split.
  - Retaining walls may be required for the L Street entrance ramp to the J Street bridge and near the intersection of I Street and 28<sup>th</sup> Street to accommodate the widening of US-75. Right-of-way may also be required near the 28<sup>th</sup> Street and I Street intersection.
- SB mainline considerations include the following:
  - The CD road would no longer be necessary with the F Street interchange removal. Two lanes from EB I-80, two lanes from SB I-480, and one lane from WB I-80 would be provided (five lanes total). The fifth SB lane would be an auxiliary lane that would extend under F Street and be terminated with a two-lane exit ramp at L Street.
  - The existing retaining wall along 29<sup>th</sup> Street between I Street and J Street will likely require replacement with taller walls.
- The F Street bridge (S075 08766) would be replaced in order to operate as an overpass maintaining east-west traffic circulation and to provide sufficient lateral clearance for the recommended number of lanes.

### **L Street and Q Street Interchanges**

- For the Q Street interchange, a reconfiguration to a diamond interchange is recommended to improve the existing geometrics at Q Street. The diamond design would be completed with the addition of a NB entrance ramp near O Street.
- The new Q Street NB entrance ramp and the relocated SB exit ramp may require short walls between the frontage roads (25<sup>th</sup> Street and 26<sup>th</sup> Street).
- The L Street interchange would be reconfigured as a half interchange, with ramps oriented to the north, to improve US-75 mainline operations. This would remove the poor weaving operations between the L Street and Q Street interchanges in the existing configuration.
- Retaining walls may be required on SB US-75 south of L Street where existing walls may require replacement near 26<sup>th</sup> Street. Some minor right-of-way may be required in this area as well.
- Improvements along 25<sup>th</sup> Street and 26<sup>th</sup> Street are recommended to provide access to/from US-75 south of Q Street. Two-way traffic flow would be maintained on 25<sup>th</sup> Street between O Street and L Street, and 26<sup>th</sup> Street would be converted to a two-way facility from O Street and extended to L Street. South of O Street, 25<sup>th</sup> Street and 26<sup>th</sup> Street would maintain their current operation as one-way roadways.

### **US-75 Mainline, L Street to Q Street**

- Four lanes are recommended on the US-75 mainline between L Street and Q Street.
- The L Street and Q Street bridges (S275 18910 and S075 08663) would be replaced in order to provide sufficient lateral clearance for the recommended number of lanes.
- The O Street bridge (S075 08682) would be removed and will not be replaced.

### **US-75 Mainline, Q Street to Chandler Road**

- Four lanes are recommended on the US-75 mainline between Q Street and Chandler Road.
- Potential widening of the UPRR bridges was reviewed by others. It was determined that the bridges (S075 08580L and S075 08580R) could be widened to the inside to fit four 12-foot-wide lanes in each direction, with 2-foot-wide inside shoulders and 4-foot-wide outside shoulders. Concept proofing options were developed to widen the bridges

on the inside and outside to accommodate 6.5-foot-wide inside shoulders and 10-foot-wide outside shoulders, but these options were dropped from consideration by NDOT.

- To maintain the 40-foot-wide median north of Childs Road, the bridges at Chandler Road (S075 08495L and S075 08495R) will need to be widened on both sides.
- Retaining walls may be needed in both directions on the outside of US-75 from Gilmore Avenue (UPRR bridges) to the Q Street ramps to accommodate widening.
- Retaining walls may also be needed on SB US-75 from the south side of the UPRR viaduct to the Chandler Road exit ramp.

### **Chandler Road Interchange**

- Additional turn bay storage is recommended at the Chandler Road interchange on the SB exit ramp to accommodate queues during the PM peak period.

### **US-75 Mainline, Chandler Road to Cornhusker Road**

- Four lanes are recommended on the US-75 mainline between Chandler Road and Cornhusker Road.
- The typical section south of Childs Road would be changed from a 60-foot-wide median to a 40-foot-wide median with a high-tension cable barrier down the center of the median. The new typical section will run from Childs Road through the N-370 interchange.
- In the SB direction, the fourth basic lane would be terminated as a two-lane exit ramp at Cornhusker Road.
- In the NB direction, the fourth basic lane would begin as a lane add at Cornhusker Road.
- The US-75 bridges over the railroad and 15<sup>th</sup> Street (S075 08248L and S075 08248R) would require widening on the inside of the structures.
- Retaining walls may be required SB US-75 north and south of the Childs Road overpass.

### **Cornhusker Road Interchange**

- A DDI is recommended at the Cornhusker Road interchange to accommodate future traffic volumes.
- The DDI could be constructed using the existing Cornhusker Road bridge over US-75.
- The existing pedestrian bridge, located on the north side of Cornhusker Road, would also be maintained as part of the new DDI.
- No right-of-way will be required to convert this diamond interchange to a DDI.

### **US-75 Mainline, Cornhusker Road to N-370**

- Three basic lanes and a fourth auxiliary lane are recommended on the US-75 mainline between Cornhusker Road and N-370.
- In the SB direction, the auxiliary lane would be added as a one-lane entrance ramp from Cornhusker Road and would be terminated as a two-lane exit ramp at N-370.
- In the NB direction, the third basic lane would be added with the existing loop ramp from EB N-370 to NB US-75. The auxiliary lane would be added as a one-lane entrance ramp from WB N-370 to NB US-75. The auxiliary lane would be terminated as a two-lane exit ramp at Cornhusker Road.
- The widening of N-370 west of US-75 to a six-lane section is recommended and was included in the Preferred Regional Strategy Package in Phase 2.

### **N-370 Interchange**

- The widening of N-370 through the interchange is recommended to accommodate future traffic volumes. There is enough horizontal clearance under the existing US-75 bridges to accommodate necessary widening.
- The SB US-75 bridge over N-370 will require widening to accommodate both the third through lane with the loop ramp taper and merge.



- It is recommended that additional turn bay storage and lanes be provided on the SB exit ramp to accommodate future volumes and queues during the PM peak period. The existing US-75 structures over N-370 will be maintained.

### Summary of US-75 (Kennedy Freeway) Concepts and Sub-Options

The concepts and sub-options considered for the I-480 corridor during Phase 3 are summarized in **Table 3.5**.

**Table 3.5. Summary of US-75 (Kennedy Freeway) Concepts and Sub-Options**

US-75 (Kennedy Freeway)			
Concept	Name	Description	Phase 3 Decision
1	Kennedy Freeway Recommended Plan	Follows recommendations from the 2001 Kennedy Freeway Planning Study except for the following: - Full interchange at Q Street with minor side street reconfiguration. - DDI at Cornhusker Road.	Selected
<b>Sub-Option</b>			
A	F Street Interchange Closure	Permanently close F Street interchange.	Selected
B	Ramp Metering	Candidate locations: AM: NB entrance ramps at Chandler Road, Q Street, and L Street. PM: SB entrance ramps at Q Street.	Retained for further consideration

### US-6 (West Dodge Road) Corridor

The recommended concept and relevant findings from concept proofing for the US-6 corridor are described below, beginning at the west end. The recommended concept figures and typical sections are included in **Appendix F**. Considerations pertaining to roadway, bridge, and traffic operations, as well as the input provided by NDOT that affected the recommended concept, are also noted. No mainline operational needs were identified west of the N-31 Interchange (204<sup>th</sup> Street), so the discussion begins at the N-31 Interchange.

#### N-31 (204<sup>th</sup> Street) Interchange

- The existing single-point urban interchange (SPUI) configuration is expected to provide the best overall LOS in year 2040, with various LOS 'E' and 'F' movements during peak hours. It is recommended that additional turn bay storage and lanes be provided on the WB exit ramp to accommodate queues during the PM peak period.
- The widening of N-31 south of West Dodge Road and through the interchange itself to a six-lane section is recommended and was included in the Preferred Regional Strategy Package in Phase 2. The one additional NB/SB through lane on N-31 will allow more green time for turning movements at the N-31 interchange.
- A two-lane entrance ramp from N-31 to EB West Dodge Road would be provided to improve the SB dual left-turn lanes utilization approaching the interchange and is recommended because the existing one-lane entrance ramp would be over capacity.

#### West Dodge Road Mainline, N-31 to 192<sup>nd</sup> Street

- The West Dodge Road mainline currently transitions from a four-lane section (two lanes in each direction) to a six-lane section (three lanes in each direction) within the N-31 interchange. The third EB lane is added on the left, upstream of the entrance from N-31. The third WB lane is dropped on the left, downstream of the exit ramp to N-31. Revisions to this configuration are recommended to improve ramp operations at the N-31 interchange while minimizing the need for additional mainline lanes east of the N-31 ramps.
- In the EB direction, the two mainline lanes over N-31 would shift to the left. The existing entrance ramp from N-31 that begins as a two-lane ramp and tapers to a one-lane ramp upstream of the ramp gore would be widened to the outside to provide two lanes through the ramp gore area and ramp taper, becoming two added mainline lanes, for a total of four EB lanes east of the N-31 interchange (one more than the existing configuration). The right-most lane would become an auxiliary lane and would drop at 192<sup>nd</sup> Street as a two-lane exit ramp. The widening may involve a retaining wall along a portion of its length to avoid channel and right-of-way impacts.
- In the WB direction, no additional mainline lanes are needed to serve year 2040 traffic volumes. However, the existing three mainline lanes approaching N-31 would split to two lanes to N-31 and two lanes continuing on WB West Dodge Road. The two-lane exit ramp to N-31 is needed to serve year 2040 traffic volumes. Widening along the north side of West Dodge Road will be necessary beginning east of the ramp taper and extending to west of the ramp gore to allow the outer WB through lane to become a second exit ramp lane. The widening may include a length of retaining wall along the ramp shoulder to avoid right-of-way impacts.

#### 192<sup>nd</sup> Street Interchange

- The proposed reconstruction of the 192<sup>nd</sup> Street interchange was included in the BNA, announced in September 2016, to accommodate new development along the 192<sup>nd</sup> Street corridor.
- It is anticipated that 192<sup>nd</sup> Street will be widened to a four-lane section and that the interchange will be reconfigured as a DDI. The configuration shown in **Appendix F** is included as a representative illustration of the interchange reconfiguration.

### West Dodge Road Mainline, 192<sup>nd</sup> Street to 156<sup>th</sup> Street

- One additional basic lane (four lanes total) is recommended in both directions of West Dodge Road between 192<sup>nd</sup> Street and 156<sup>th</sup> Street. In the EB direction, the fourth basic lane would be added with the 192<sup>nd</sup> Street entrance ramp. In the WB direction, the fourth basic lane would be terminated with a two-lane exit ramp to 192<sup>nd</sup> Street.
- The four-lane section under the bridges at 180<sup>th</sup> Street, 168<sup>th</sup> Street, and 156<sup>th</sup> Street will require a shoulder exception to avoid replacement of the bridges. From a safety perspective, Phase 2 determined that providing four 12-foot-wide lanes with narrow shoulders would be better than providing four 11-foot-wide lanes and slightly wider shoulders.
- An auxiliary lane (five lanes total) is recommended in both directions of West Dodge Road between 180<sup>th</sup> Street and 168<sup>th</sup> Street. The EB auxiliary lane would be terminated with a two-lane exit ramp at 168<sup>th</sup> Street. Widening for the EB auxiliary lane may involve a retaining wall between EB West Dodge Road and Chicago Street, extending from the 180<sup>th</sup> Street entrance ramp gore and the 168<sup>th</sup> Street exit ramp gore. Several segments of retaining wall may be needed along the WB auxiliary lane between West Dodge Road and adjacent properties. The WB auxiliary lane would be terminated with a two-lane exit ramp at 180<sup>th</sup> Street.
- An auxiliary lane (five lanes total) is recommended in both directions of West Dodge Road between 168<sup>th</sup> Street and 156<sup>th</sup> Street. The EB auxiliary lane would be terminated with a two-lane exit ramp at 156<sup>th</sup> Street. The WB auxiliary lane would be terminated with a two-lane exit ramp at 168<sup>th</sup> Street.
- The WB widening may involve segments of retaining wall between the West Dodge Road bridges over the UPRR tracks and West Papillion Creek, and along the West Dodge Road frontage road between the West Papillion Creek bridge and 156<sup>th</sup> Street. The EB widening will involve retaining walls between West Dodge Road and the adjacent neighborhood properties to the south.
- The widening of West Dodge Road by two lanes in each direction between 168<sup>th</sup> Street and 156<sup>th</sup> Street will likely impact the vertical clearance provided at the West Dodge Road bridge (S006 35999) over the UPRR tracks, just east of 168<sup>th</sup> Street. It is assumed that simple widening of the existing bridge, which already has deficient clearance over the railroad (23.11 feet), would further drive down the low steel elevation and would not be permitted by UPRR. Options identified to mitigate the clearance issue that appear to be feasible are summarized as follows:
  - Re-profile West Dodge Road – Modify the profile of West Dodge Road to allow full vertical clearance over the UPRR. Full reconstruction of the bridge over the UPRR as well as the adjacent bridge over the West Papillion Creek would be required.
  - New steel superstructure with modified piers – Remove and replace the existing concrete superstructure and deck with steel girders on a modified pier cap and a new deck. Replacement steel girders could be thinner than the existing girders and spacing between girders reduced to less than optimal to achieve the needed clearance over the UPRR.
  - New IT900 superstructure with modified or rebuilt piers – Remove and replace the existing concrete superstructure and deck with concrete IT900 girders on a modified pier cap and a new deck. The IT900 girders would be 1.50 feet thinner than the existing girders to allow widening the bridge section while providing 23.33 feet of clearance over the UPRR. Existing pier foundations would need analysis to confirm ability to support the heavier girders.
  - New post-tensioned superstructure with modified piers – Remove the existing superstructure, modify pier caps and install a post-tensioned concrete girder superstructure and new deck. The replacement superstructure is anticipated to be thin enough to allow deck widening and provide necessary clearance over the UPRR.
  - Separate ramp bridges – Modify the existing UPRR Bridge to carry four basic lanes in each direction and place the ramps on the east side of 168<sup>th</sup> Street on structures separate from the mainline bridge. Separation of the ramps would provide flexibility in the ramp profiles and structure type/depth. The ramp

gores would need to be moved further east, reducing the weaving distance between 168<sup>th</sup> Street and 156<sup>th</sup> Street interchanges.

- The recommended concept figures in **Appendix F** reflect the option of reconstructing the bridge superstructure with shallow girders to provide minimum vertical clearance over the UPRR tracks and avoid the need to reconstruct the bridge over West Papillion Creek.

### 180<sup>th</sup> Street, 168<sup>th</sup> Street, and 156<sup>th</sup> Street Interchanges

- The existing SPU configurations at 180<sup>th</sup> Street, 168<sup>th</sup> Street, and 156<sup>th</sup> Street are expected to provide acceptable overall LOS in year 2040. It is recommended that additional turn lanes and turn bay storage be provided on the WB exit ramp approaches to the ramp terminal intersections at each interchange to accommodate queues during the PM peak period.
- Retaining walls will typically be needed between the widened West Dodge Road mainline and the SPU ramps at each of the interchanges to avoid the need to reconstruct the ramps between the gore area and the terminal intersection.
- The widening of 156<sup>th</sup> Street north and south of West Dodge Road to a four-lane section is included in the City of Omaha's 2019–2024 Capital Improvement Program.

### West Dodge Road Mainline, 156<sup>th</sup> Street to 132<sup>nd</sup> Street

- For WB West Dodge Road, five basic lanes plus one auxiliary lane between interchanges (six lanes total) are recommended from 132<sup>nd</sup> Street to 156<sup>th</sup> Street. The fifth basic lane would terminate at 156<sup>th</sup> Street with a two-lane exit ramp. Lane balance would not be provided at this split. Auxiliary lanes would be terminated with two-lane exits at the interchanges. The following structures would be impacted with the addition of two WB basic lanes:
  - 144<sup>th</sup> Street Bridge over West Dodge Road (S006 36192): This structure would need to be reconstructed in order to provide five 12-foot-wide lanes underneath 144<sup>th</sup> Street.
  - West Dodge Road Bridge over 137<sup>th</sup> Street (S006 36240): The widening of this structure with beams sized to match the existing beams would reduce the vertical clearance from the 14.00 feet provided today. Therefore, it has been assumed that this bridge would need to be reconstructed with shallow depth beams to maintain the current vertical clearance.
- For EB West Dodge Road, four basic lanes plus one auxiliary lane between interchanges (five lanes total) are recommended from 156<sup>th</sup> Street to 132<sup>nd</sup> Street. This will result in an imbalance in the number of EB travel lanes compared to WB travel lanes. The imbalance is attributed to the following two key decisions made during MTIS:
  - Hierarchy of the Freeway System: Providing additional capacity on EB West Dodge Road would likely result in additional traffic growth and congestion on I-680. NDOT would prefer that localized congestion occur on EB West Dodge Road so as to “meter” the amount of traffic getting to I-680 and thus maximize the quality of traffic flow on I-680.
  - EB Expressway Bridge: NDOT does not support the provision of four lanes on the EB West Dodge Expressway bridge due to the potential safety issues associated with the downgrade approaching the West Dodge Road / I-680 split. Discussion regarding the WB Expressway bridge is provided later in this West Dodge Road corridor summary.
- Along both EB and WB West Dodge Road between 156<sup>th</sup> Street and 144<sup>th</sup> Street, between 144<sup>th</sup> Street and 137<sup>th</sup> Street, and between 137<sup>th</sup> Street and 132<sup>nd</sup> Street, the recommended widening will involve retaining walls along portions of the interchange ramps and the mainline shoulders to avoid right-of-way impacts.

### 150<sup>th</sup> Street Interchange

- The 150<sup>th</sup> Street interchange has been reconstructed as part of a new development south of West Dodge Road between 150<sup>th</sup> Street and 144<sup>th</sup> Street. An EB exit ramp has been added, resulting in a full-access interchange.
- A new 150<sup>th</sup> Street bridge over West Dodge Road was included with the interchange reconstruction. This bridge will allow for the ultimate mainline configuration under 150<sup>th</sup> Street (four EB lanes and five WB lanes).



- Retaining walls will be needed between the widened WB lanes and the 150<sup>th</sup> Street WB ramps.

### 144<sup>th</sup> Street Interchange

- The 144<sup>th</sup> Street interchange is currently being expanded as part of a new development south of West Dodge Road between 150<sup>th</sup> Street and 144<sup>th</sup> Street. The expansion, to be completed in 2019, will provide acceptable operations at the 144<sup>th</sup> Street interchange through year 2040.
- Additional through lanes on 144<sup>th</sup> Street and dual right-turn lanes at the ramp terminal intersections have been constructed as part of this expansion.
- Retaining walls will typically be needed between the widened West Dodge Road mainline and the SPUI ramps at the 144<sup>th</sup> Street interchange to avoid the need for additional right-of-way.

### 137<sup>th</sup> Street Interchange

- Improvements to the 137<sup>th</sup> Street interchange configuration are not required to serve 2040 traffic volumes.

### 132<sup>nd</sup> Street Interchange

- Interchange needs for the 132<sup>nd</sup> Street interchange were identified in Phase 2. However, retention of the existing interchange configuration is recommended for reasons similar to those discussed in the West Dodge Road Mainline, 192<sup>nd</sup> Street to 156<sup>th</sup> Street section. Any interchange improvement will allow more traffic onto EB West Dodge Road, which will make future operations worse at the weave between 132<sup>nd</sup> Street and 120<sup>th</sup> Street.
- Improvements to the 132<sup>nd</sup> Street interchange configuration are not required to serve year 2040 traffic volumes. However, it is recommended that dual right-turn lanes and dual left-turn lanes be provided on the WB exit ramp approach to 132<sup>nd</sup> Street to accommodate queues during the PM peak period.

### West Dodge Road Mainline, 132<sup>nd</sup> Street to 120<sup>th</sup> Street

- Options that were considered for the West Dodge Road mainline between 132<sup>nd</sup> Street and 120<sup>th</sup> Street were greatly influenced by the presence of the two-way frontage roads that are located immediately adjacent to both sides of West Dodge Road (separated by barrier rail). These frontage roads provide local access to numerous commercial properties, office buildings, apartment buildings, and school facilities.
- The need for improvements on the West Dodge Road mainline between 132<sup>nd</sup> Street and 120<sup>th</sup> Street are driven largely by poor weaving operations between 132<sup>nd</sup> Street and 120<sup>th</sup> Street. For both EB and WB West Dodge Road, options were considered that would eliminate this weave by channelizing ramp movements (Phase 2 sub-options C1 and C2, in which traffic to and from 132<sup>nd</sup> Street and 120<sup>th</sup> Street would be kept separated from the West Dodge Road Expressway), as follows:
  - For WB West Dodge Road, access to 132<sup>nd</sup> Street would be provided only from WB local West Dodge Road (that is, lower West Dodge Road via the entrance ramp from 120<sup>th</sup> Street) and not from the upper WB West Dodge Road Expressway.
  - For EB West Dodge Road, traffic on the 132<sup>nd</sup> Street entrance ramp would be able to get to EB local West Dodge Road but not to the upper EB West Dodge Road Expressway. To access I-680, users would need to travel through the 120<sup>th</sup> Street and 114<sup>th</sup> Street intersections and utilize the Old Mill entrance ramp at the I-680 / West Dodge Road system interchange.
  - For both directions, additional barriers and shoulders would be necessary.
  - These options were eliminated for two reasons: (1) because of right-of-way impacts; and (2) because NDOT does not support restricting access 24 hours per day to solve a peak period problem.
- For WB West Dodge Road, five basic lanes plus one auxiliary lane (six lanes total) are recommended between 120<sup>th</sup> Street and 132<sup>nd</sup> Street (four lanes from the WB West Dodge Expressway bridge and two lanes from the 120<sup>th</sup> Street entrance ramp). The auxiliary lane would be terminated with a two-lane exit ramp to 132<sup>nd</sup> Street. Providing six WB lanes in this section will have the following impacts:

- Additional right-of-way will be necessary along the WB frontage road from just west of 129<sup>th</sup> Street to the Menards property.
- The north side West Dodge Road frontage road will require reconstruction for approximately the same limits as the right-of-way impacts described above.
- For EB West Dodge Road, the provision of additional lanes is not recommended because, as discussed previously, NDOT does not support having four lanes on the EB West Dodge Road Expressway bridge. To maintain the existing four lanes in this section, the entrance ramp from 132<sup>nd</sup> Street would taper, with the four basic lanes carried under the 132<sup>nd</sup> Street bridge. The option to add an additional auxiliary lane (five lanes total) did not have a significant improvement to EB operations or volume throughput during the AM peak period.

### West Dodge Road Mainline, Expressway Bridges

- Widening the West Dodge Road Expressway bridges is neither feasible nor practical based on the type, size, and location of the support piers.
- Phase 3 investigated converting the existing West Dodge Road Expressway bridges from three lanes to four lanes. These bridges typically have a 47.24-foot clear roadway width between faces of the bridge barrier rails. The conversion would provide four 11-foot-wide lanes and 1.62-foot shy distance from the outside lanes to the existing barrier rails.
- NDOT eliminated further consideration of four lanes on the EB West Dodge Road Expressway bridge due to potential safety issues associated with the downgrade on the bridge deck between approximately 120<sup>th</sup> Street and 114<sup>th</sup> Street.
- Four lanes on the WB West Dodge Road Expressway bridge is recommended. Additional considerations include the following:
  - The alignment goes through reverse curvature near 120<sup>th</sup> Street. The existing cross section crown line is located 8.22 feet from the right edge of the roadway. From this point, the pavement slopes 0.034 foot/foot downward toward the interior barrier and slopes 0.02 foot/foot downward toward the outside barrier, resulting in a cross slope break over of 5.4 percent. With a four-lane configuration, a vehicle in the right-most lane would be straddling this crown line. NDOT conducted a field analysis using a ball bank indicator for a vehicle in this lane at various speeds and concluded that this condition would not create a safety risk or cause driver discomfort.
  - Hard Shoulder Running (HSR) was considered as a means to provide four lanes on the WB West Dodge Road Expressway bridge only during peak congestion times or during construction and incidents. This would require special attention to signing and pavement markings. NDOT did not support this concept. HSR is discussed later in this chapter.
- The addition of overhead lane use signs or signal indications for TIM or weather events to the WB West Dodge Road Expressway bridge could be feasible, but would require structural analysis and detailing for confirmation and development of location and attachment restrictions.

### I-680 / West Dodge Road (US-6) System Interchange

- The following two options were developed to improve the EB West Dodge Road weave east of the Old Mill entrance ramp at the I-680 / West Dodge Road system interchange:
  - Ramp Reconfiguration and Channelization: This option would remove the weave by adding an exit ramp for the EB West Dodge Road Expressway to NB I-680 movement while adding barriers to channelize specific movements (see Phase 2 sub-option B). This option was ultimately eliminated from further consideration for the following reasons:
    - NDOT does not support a freeway-to-freeway (West Dodge Road to I-680) movement that would be directed off of the freeway system and then back onto the freeway to make the movement.
    - NDOT does not support a left-hand merge on the EB West Dodge Road to SB I-680 ramp.

- NDOT does not support four lanes on the EB West Dodge Road Expressway (noted previously). A three-lane expressway would restrict the flow rate of traffic from the West Dodge Road Expressway into the I-680 / West Dodge Road system interchange, inhibiting traffic growth in this area. Sub-option B would be justified only if four lanes were provided on the West Dodge Road Expressway.
  - Existing Configuration with Localized One-Lane Expansion: This option would expand the EB West Dodge Road Expressway bridge to four lanes in a portion of the EB West Dodge Road Expressway just east of 114<sup>th</sup> Street, where right-of-way would allow for potential bridge widening and related pier modifications. The four-lane widened section would provide a third lane on the EB ramp to I-680 while maintaining two lanes to West Dodge Road. This option was ultimately eliminated from further consideration for the following reasons:
    - Similar to the first option, a three-lane expressway upstream of the expansion would inhibit traffic flow into the expansion area. Expanding the EB West Dodge Road Expressway to four lanes for the localized portion of the bridge does not improve EB throughput for the West Dodge Road corridor. There would be a moderate improvement only in the weaving area.
    - This option would require six lanes to be provided on SB I-680 through the Pacific Street interchange. The alternative of dropping the sixth SB I-680 lane at the SB Pacific Street exit ramp (1.5 miles downstream) would not provide a significant operations benefit.
- For the reasons described previously, and to maintain the hierarchy of the freeway system (I-680 over West Dodge Road), the existing configuration was selected as the recommended concept.
- Two options were developed to improve the WB West Dodge Road weaving section at the I-680 / West Dodge Road system interchange. Both options include a three-lane NB I-680 to WB West Dodge Road directional ramp. Adding the third ramp lane would require widening the NB to WB ramp bridge over I-680 along its north side. The two options are as follows:
  - SB I-680 to WB West Dodge Road Expressway Merge: This option would relocate the SB I-680 ramp and braid it underneath the NB I-680 to WB West Dodge Road directional ramp. Barriers would be used to restrict traffic movements to the West Dodge Road Expressway or to local West Dodge Road and the Old Mill area, and eliminate the weaving section. The SB I-680 ramp to the expressway would merge with traffic from local West Dodge Road to the West Dodge Road Expressway. NDOT did not support the SB I-680 ramp merging with ramp traffic from local West Dodge Road, so the option was ultimately eliminated (see Phase 2 sub-option A1).
  - SB I-680 Split Directional Ramps: This option would keep the existing SB I-680 ramp alignment, but would limit traffic on that ramp to only access the WB West Dodge Road Expressway. An additional ramp would be braided underneath the NB I-680 to WB West Dodge Road directional ramp to provide SB I-680 access to local West Dodge Road and the Old Mill area. With a four lane WB West Dodge Road Expressway bridge, this option provides acceptable LOS at the I-680 interchange. NDOT supports this configuration because it gives NDOT some flexibility with a phased implementation of the ultimate lane configuration, as follows:
    - Interim: One lane from WB West Dodge Road and two lanes from I-680.
    - Full-Build Option A: Two lanes from WB West Dodge Road and two lanes from I-680. This option is the recommended concept and is shown in **Appendix F**.
    - Full-Build Option B: One lane from WB West Dodge Road and three lanes from I-680 (one from SB I-680 and two from NB I-680). This option would require some localized widening on the West Dodge Road Expressway bridges (S006 36484B and S006 36428B) in the gore area of the connection between I-680 ramps and WB West Dodge Road to the West Dodge Road Expressway.
- For the reasons described previously, the SB I-680 Split Directional Ramps – Full-Build Option A configuration was selected as the recommended concept.

### Summary of US-6 (West Dodge Road) Concepts and Sub-Options

The concepts and sub-options considered for the US-6 (West Dodge Road) corridor during Phase 3 are summarized in **Table 3.6**.

**Table 3.6. Summary of US-6 (West Dodge Road) Concepts and Sub-Options**

US-6 (West Dodge Road)			
Concept	Name	Description	Phase 3 Decision
1	Mainline Widening West of 120 <sup>th</sup> Street with 4-Lane WB Expressway Bridge	Addition of 1 lane in each direction plus auxiliary lanes depending on location. Narrow lanes and shoulders to provide 4 WB lanes on elevated portion of West Dodge Road Expressway (2 lanes from West Dodge Road, 2 lanes from I-680). DDI at 192 <sup>nd</sup> Street.	Selected
2	Mainline Widening West of 120 <sup>th</sup> Street Only	Equal to Concept 1 but retains current 3 WB lanes on elevated portion of West Dodge Road Expressway (1 lane from West Dodge Road, 2 lanes from I-680 per NDOT interim project).	Not Selected – A 4-lane configuration on the West Dodge Road Expressway bridge is needed to provide acceptable traffic operations.
3	Mainline Widening in WB Direction Only	No improvements in the EB direction. Equal to Concept 1 for WB.	Not Selected – NDOT concurred that a 4-lane basic freeway section is needed for EB West Dodge Road at a minimum based on traffic operations.
<b>Sub-Option</b>			
A1	I-680 / WB West Dodge Road System Interchange Weave Improvement	Eliminate weaving section and provide 4 WB lanes on elevated portion.	Selected
A2	I-680 / WB West Dodge Road System Interchange Weave Improvement	Eliminate weaving section and provide 3 WB lanes on elevated portion.	Not Selected – Not compatible with recommended concept (#1)
B	I-680 / EB West Dodge Road System Interchange Weave Improvement	Eliminate existing weaving section.	Not Selected – Minimal traffic volume growth expected in this location due to the EB Expressway bridge remaining a 3-lane section.
C1	West Dodge Road Channelization between 132 <sup>nd</sup> Street and 120 <sup>th</sup> Street	EB entrance ramp traffic from 132 <sup>nd</sup> Street is channelized to local West Dodge Road.	Not Selected – NDOT decided to avoid full-time restriction of traffic movements to the CD road and additional right-of-way impacts
C2		WB traffic from elevated West Dodge Road Expressway to 132 <sup>nd</sup> Street WB exit ramp not allowed (barrier).	
D	WB West Dodge Road Mainline Expansion (2 Lanes) from 132 <sup>nd</sup> Street to 156 <sup>th</sup> Street	Additional lanes to mitigate poor LOS operations in WB direction only.	Selected
E	150 <sup>th</sup> Street and 137 <sup>th</sup> Street Ramp Closures	Permanent or peak hour closures at 0.5 mile interchanges at 150 <sup>th</sup> Street and 137 <sup>th</sup> Street.	Not Selected – Not supported by Stakeholder Committee
F	Ramp Metering	Candidate locations: AM: All EB entrance ramps from 192 <sup>nd</sup> Street through 132 <sup>nd</sup> Street (and Old Mill Road EB). PM: All WB entrance ramps from 120 <sup>th</sup> Street through 156 <sup>th</sup> Street (and Old Mill Road EB).	Retained for further consideration



## Other Strategy Considerations

The following non-traditional strategies were also evaluated as part of MTIS, either as alternatives to the recommended freeway concepts or as complimentary features of the recommended freeway concepts.

### Hard Shoulder Running

HSR may be an effective strategy for operations reliability of a facility in particular situations. HSR is defined as follows:

- The shoulder is used for travel only during those times of day when the adjoining lanes are likely to be heavily congested (for example, during peak hours, when congestion is detected, or when general purpose lanes are closed for construction or incidents).
- When not needed as an additional travel lane, the shoulder is restored to its original purpose as a “shoulder,” and the basic physical characteristics of the shoulder are retained and recognizable.

Although HSR may be used as an interim treatment while a conventional project (for example, construction of additional lanes) awaits funding or completion, it may also be used indefinitely. Other features include the following:

#### Shoulder Option

- Right shoulder
- Left shoulder

#### Vehicle-Use Options

- Open shoulder to transit vehicles only
- Open shoulder as a high-occupancy vehicle (HOV) lane that permits carpools and transit vehicles to use it
- Open shoulder as a high-occupancy toll (HOT) lane that allows vehicles to pay a toll to use it if they do not meet HOV occupancy requirements
- Open shoulder to all vehicles except trucks
- Open shoulder to all vehicles

#### Operating Options

- Dynamically open shoulder when certain congestion thresholds are reached
- Statically open shoulder during specified historical peak periods (time of day)

#### Speed Control Options

- Same speed limit as other lanes (at posted speed limits)
- Same speed as other lanes (at a reduced speed relative to normal posted speed limits)
- Lower speed limit than other lanes

Based on existing and future congestion levels, consideration of the applicability of HSR in the Omaha metropolitan area was limited to the I-80 and West Dodge Road corridors. A planning-level assessment of the applicability of HSR in these corridors was performed in Phase 2. The following issues were identified as potential obstacles to the implementation of HSR and led to HSR being eliminated from further consideration as a corridor-wide strategy:

#### Design Issues

- The existing shoulder widths on I-80 and West Dodge Road are inadequate to accommodate HSR. The existing width of the right shoulder is generally 10.0 feet in the I-80 and West Dodge Road corridors. The width of the left

shoulder is generally 12.5 feet on I-80 and 9.0 feet on West Dodge Road (measured to the face of the barrier). In both corridors, storm drain inlets are located within the left shoulder.

- HSR on the right shoulder is not compatible with two-lane exit ramps, which are predominate in both corridors.
- Loop entrance ramps that add an auxiliary lane present unique challenges with HSR on the right shoulder.
- Carrying HSR through system interchanges can be difficult, especially if shoulder width is already under 12 feet.
- Clear zone protection may need to be redesigned and reconstructed to accommodate vehicles on the shoulder.
- Shoulder pavement depth must be able to handle normal traffic.

#### Other Potential Issues

- Regular sweeping would be necessary to prevent the accumulation of debris on the shoulders.
- Snow removal methods and policies may need to be modified.
- During HSR operation, disabled vehicles and emergency situations would limit the effectiveness of HSR. Additional systems to detect and clear disabled vehicles would need to be implemented with HSR.
- Law enforcement stops during HSR would need to take place at other locations.
- Potential weaving at the end points of HSR would need to be addressed.

In Phase 3, additional consideration was given to the application of HSR as a means to providing additional capacity on the WB West Dodge Road Expressway bridge. A permanent conversion of the existing three travel lanes to four travel lanes would result in 11-foot-wide lanes and a 1.62-foot-wide shy distance from the outside lanes to the existing barrier rails. Alternatively, three 11-foot-wide travel lanes and a 12-foot-wide outside shoulder could be provided, and the shoulder could be used as a travel lane during peak congestion times or during incidents. This would require special attention to signing and pavement markings, particularly at the transition areas. Although this concept would appear to be feasible, NDOT prefers to implement a permanent conversion of the existing three travel lanes to four travel lanes at some point in the future.

#### Bus on Shoulder

Bus on Shoulder (BOS) operation allows authorized transit vehicles to use the shoulder to avoid congestion in the general purpose lanes. This application improves person-throughput along a corridor and incentivizes the use of mass transit. BOS is unique from other part-time shoulder use strategies because low volumes on the shoulder (compared to opening the shoulder to general traffic) minimize the need for updated signing, pavement markings, and Intelligent Transportation Systems (ITS) equipment. BOS also minimizes the impacts for emergency response to incidents and storage of broken-down vehicles. While most BOS applications use the right shoulder, systems in Chicago, Cincinnati, and Columbus use the left shoulder.

MAPA and Metro have expressed interest in BOS operations on I-80 and West Dodge Road. In particular, Metro believes that BOS could make transit very attractive in these corridors and that implementation costs would be relatively low. Left-shoulder running is far more attractive from an operational standpoint to avoid the interference between buses and other vehicles merging and diverging at interchanges. Metro also believes that BOS could be justified during all hours of transit operations as opposed to peak periods only. Although BOS would face similar challenges to those identified for HSR in the previous section, these challenges would be partially offset or mitigated by the relative infrequency of buses using the shoulder and by requiring that bus drivers be trained in the use of BOS.

A BOS strategy has not been directly included in the recommended freeway vision. However, given the strong interest expressed by MAPA and Metro, BOS should continue to be evaluated for possible implementation in the future.

### **Ramp Metering**

Ramp metering is a potential tool to address commonly occurring congestion and safety issues. Despite initial opposition and skepticism from various stakeholders, ramp metering has been deployed, sustained, and even expanded in many metropolitan areas across the United States.

Ramp meters are traffic signals installed on freeway entrance ramps to control the frequency at which vehicles enter the flow of traffic on the freeway. Ramp metering reduces overall freeway congestion by managing the amount of traffic entering the freeway and by breaking up platoons that make it difficult to merge onto the freeway. Vehicles traveling from an adjacent arterial onto the ramp form a queue behind the stop line. The vehicles are then individually released onto the mainline, often at a rate that is dependent on the mainline traffic volume and speed at that time. The configuration can be altered to accommodate transit and HOV policies or existing geometric limitations.

Other typical features of ramp metering are summarized as follows:

#### **Hours of Operation**

- Typically by time of day
- Sometimes based on traffic operations

#### **Metering Rate**

- 240 - 1600 vehicles per hour (vph)

#### **Multi-Lane Release Sequence**

- Typically alternating
- Sometimes both lanes simultaneously

#### **Queue Management**

- Additional queue storage can be provided on the entrance ramp and arterial turn bays.
- Releasing the entire ramp queue at one time is not recommended.
- Spillback detection can be used to increase the metering rate to reduce queuing onto arterial streets.

#### **Criteria for Implementing Ramp Meters**

- Mainline flow of at least 1200 vph per lane
- Ramp flow of at least 240 vph for a one-lane ramp and 400 vph for a two-lane ramp
- Mainline speed of less than 30 miles per hour (mph) in the peak hour
- Accident rate in the vicinity of the ramp in excess of 80 per hundred million vehicle miles

#### **Queue Storage Requirements**

- Minimum of 450 feet length per metered ramp lane
- New ramp construction – Desirable to design to store 10 percent of the design year traffic on the ramp.
- Retrofit – Design to store 5 percent of the current peak hour volume on the ramp.
- Some applications may also require stopping distance for traffic approaching the back of the queue.

### **Mainline Merging**

- Most states require that the traffic on the metered ramp be able to accelerate to a merging speed within 5 mph of the freeway mainline operating speed, to allow ramp meters to be activated before mainline speeds decrease significantly.
- Operating speed is defined as the speed at which vehicles are observed operating during free flow conditions. The 85<sup>th</sup> percentile of the distribution of observed speeds is the most frequently used measure of the operating speed. For MTIS, posted speed was used as a representative operating speed.

Planning-level traffic analyses were conducted in Phase 2 to evaluate the potential benefits of ramp metering in each of the freeway corridors. The analyses showed that all of the freeway corridors could benefit operationally from ramp metering during peak periods and in the peak traffic direction.

In Phase 3, analyses were performed to further evaluate the potential operational benefits of ramp metering and the potential challenges posed by ramp metering in the West Dodge Road corridor. The analysis was limited to the West Dodge corridor because NDOT noted that West Dodge is its highest priority corridor for potential ramp metering implementation, based on recurring existing congestion and because corridor constraints and concerns for downstream corridor impacts will limit the extent of expansion along West Dodge Road. This corridor also presents the greatest challenges to ramp metering due to relatively short ramp lengths and the presence of closely spaced interchanges between 156<sup>th</sup> Street and the west end of the West Dodge Road Expressway bridges.

#### **Queue Storage and Acceleration**

The availability of queue storage space and adequate acceleration distance are primary considerations for determining if a ramp's physical characteristics are suitable for ramp metering. Balancing queue storage space and acceleration distance to the freeway is critical in the placement of the ramp meter stop bar along the ramp. When the meter is in operation, the ramp should satisfy the following requirements:

- Provide sufficient distance between the stop bar and the freeway for vehicles to accelerate to the desired operational speed.
- Provide sufficient storage upstream of the stop bar for queuing vehicles so that the queue does not back up beyond the ramp entrance.

The Phase 3 analysis first determined the required acceleration distance for acceleration from a stop condition from the American Association of State Highway and Transportation Officials' *A Policy on Geometric Design of Highways and Streets* using the posted speed (as of March 2018) on West Dodge Road and specific ramp geometry. This distance was then used to set a preliminary stop bar location on each entrance ramp.

- For a tapering entrance ramp, it was assumed that the entering vehicle will reach mainline operating speed at the point where the ramp taper reaches a 12-foot wide ramp lane.
- For an auxiliary lane entrance ramp, it was assumed that the entering vehicle will reach mainline operating speed at a point 400 feet downstream of the entrance ramp painted gore.

The required queue storage was then determined as a percentage of the existing peak hour ramp volume and an assumed vehicle length of 25 feet. This percentage varies by state but is typically equal to 5, 7, or 10 percent. For ramp meters installed on new or reconstructed ramps, the queue storage should generally provide for 10 percent of the existing peak hour ramp volume. For ramp meters retrofitted onto existing conditions, a minimum storage of 5 percent of the existing peak hour ramp volume may be used.





**Table 3.7** summarizes the queue storage analysis conducted for the EB direction of the West Dodge Road corridor.

**Table 3.8** summarizes the queue storage analysis conducted for the WB direction. The analysis assumed that two queuing lanes would be provided upstream of the ramp meter stop bar for all ramp locations.

**Table 3.7. Queue Storage Analysis – Eastbound West Dodge Road**

Ramp (EB)	Existing Peak Hour Volume (vph)		Max Volume (VPH)	Ramp Type	Queue Storage Provided (ft)	Queue Storage Required		
	AM	PM				5%	7%	10%
204 <sup>th</sup> Street	1305	940	1305	Taper	410	820	1150	1640
192 <sup>nd</sup> Street	955	470	955	Taper	140	600	840	1200
180 <sup>th</sup> Street	1195	1150	1195	Aux	1490	750	1050	1500
168 <sup>th</sup> Street	1025	1090	1090	Taper	0	690	960	1370
156 <sup>th</sup> Street	1010	780	1010	Aux	450	640	890	1270
150 <sup>th</sup> Street	610	230	610	Aux	250	390	540	770
144 <sup>th</sup> Street	1290	820	1290	Aux	550	810	1130	1620
137 <sup>th</sup> Street	105	500	500	Aux	350	320	440	630
132 <sup>nd</sup> Street	880	835	880	Aux	820	550	770	1100
Old Mill Road	880	1845	1600	Aux	810	1000	1400	2000

Red text indicates that adequate storage is not provided

**Table 3.8. Queue Storage Analysis – Westbound West Dodge Road**

Ramp (WB)	Existing Peak Hour Volume (vph)		Max Volume (VPH)	Ramp Type	Queue Storage Provided (ft)	Queue Storage Required		
	AM	PM				5%	7%	10%
120 <sup>th</sup> Street	675	1625	1625	Aux	990	1000	1400	2000
132 <sup>nd</sup> Street	460	680	680	Aux	620	430	600	850
137 <sup>th</sup> Street	50	435	435	Aux	490	280	390	550
144 <sup>th</sup> Street	505	880	880	Aux	480	550	770	1100
150 <sup>th</sup> Street	65	140	140	Aux	360	90	130	180
156 <sup>th</sup> Street	340	460	460	Taper	0	290	410	580
168 <sup>th</sup> Street	435	320	435	Aux	1200	280	390	550
180 <sup>th</sup> Street	175	565	565	Taper	150	360	500	710
192 <sup>nd</sup> Street	70	80	80	Taper	40	50	70	100

Red text indicates that adequate storage is not provided

Both **Table 3.7** and **Table 3.8** show that numerous entrance ramps along West Dodge Road will not provide adequate queue storage for ramp metering even for existing traffic volumes. This situation would be expected to worsen as traffic volumes increase in the future. Although drivers may choose alternative routes to avoid metered ramps, it is possible that ramp meter queues that exceed the available storage may significantly impact arterial street operations. To counter this, several strategies could be considered, as follows:

- Adjust the metering rate to reduce the queue
- Allow platooning (increasing the release rate beyond one vehicle per green)
- Flush the ramp queue onto the freeway by providing an extended green time for the ramp meter

- Provide real-time driver information via dynamic message signs (DMS) on the ramp and along the arterial with specific delay information
- Provide additional storage on the adjacent surface street, upstream of the ramp meter.

### Operational Benefits

The FREEVAL software program was used to estimate the operational benefits of implementing ramp metering in the West Dodge Road corridor. Depending on the metering rate at each interchange, FREEVAL showed a benefit to downstream operations along West Dodge Road. The caveat of these freeway benefits is the additional east-west traffic that will shift onto the arterial network (West Maple Road, Blondo Street, Pacific Street, and West Center Road). It is anticipated that these arterials will need to be re-timed to provide longer green times for east-west travel as well as improved signal progression if ramp metering is implemented on West Dodge Road.

Although the Phase 3 analyses identified potential operational benefits associated with ramp metering in the West Dodge Road corridor, ramp metering has not been directly included in the recommended freeway plan for the West Dodge Road corridor or any other freeway corridor based, in part, on the queue storage issues. However, this strategy should be considered as “under ongoing consideration for future implementation”, pending (1) significant further degradation of safety or operations, (2) perceptions of those issues, or (3) the advantages of ramp metering increase.

### Dynamic Lane Assignment

Dynamic Lane Use / Merge Control was investigated as a means to address congestion in areas where adding additional lanes may be challenging. This concept is applicable to situations where the peaking characteristics of two merging traffic streams are opposed to one another. That is, one traffic stream may exhibit high traffic volumes in the AM peak period but not in the PM peak period, while the other traffic stream exhibits high traffic volumes in the PM peak period but not in the AM peak period.

The concept involves “passively” closing lanes that are not needed during peak periods to allow heavier movements to merge easily with traffic stream. Because passive control will not physically prevent a vehicle from using the closed lane, it is possible that some vehicles may continue to use the closed lane. This would result in some merging maneuvers, which could be unexpected by traffic correctly using the lane subject to dynamic assignment.

This concept was considered at the following two locations on the freeway system:

- Merge of the ramp from NB US-75 to WB I-80 with the ramp from SB I-480 to WB I-80
- Merge of the WB West Dodge Road to SB I-680 ramp with southbound I-680

Per direction from NDOT, Dynamic Lane Assignment has not been directly included in the recommended freeway plan. However, given the potential operational benefits and potential construction cost savings, this strategy should continue to be evaluated for possible implementation in the future.

## Chapter 4 – Implementation Plan

This chapter summarizes the implementation plan for the recommended freeway system improvements within the MTIS study area. This plan includes projects that address the system preservation needs of the freeway system as well as expansion projects that address the operational needs of the freeway system.

### System Preservation Projects

System preservation projects are projects that are recommended to improve or sustain the condition of the freeway system in a state of good repair. System preservation projects generally do not add capacity or structural value, but are intended to restore the overall condition of the transportation facility.

Various system preservation data for the freeway system were provided by NDOT from the following sources:

- 2017 Interstate Task Force Book – This publication is prepared by NDOT's Interstate Task Force. The Task Force conducts a field inspection of the Interstate Highway System each spring, reviews existing strategies for the various interstate segments for possible changes, updates the cost and life of strategies, prioritizes and develops 1-year and 5-year plans, and provides an estimate of the Interstate needs for the next 20 years.
- Risk Assessment Model runs prepared by NDOT's Materials and Research Division.
- Estimation of a system preservation work schedule on the interstates in the Omaha metropolitan area prepared by staff from NDOT's Roadway Division, NDOT's Materials and Research Division, and NDOT District 2.
- Limited bridge system preservation data provided by NDOT's Bridge Division.

In general, the implementation plan for system preservation projects was determined by NDOT. Specifically, NDOT identified the type and time frame for each system preservation project. The HDR Project Team provided input into the cost estimates for the system preservation projects and assisted in the identification of opportunities to combine system preservation projects with capacity expansion projects.

The following types of system preservation projects were included in the implementation plan:

- Full reconstruction
- Mill and overlay
- Diamond grinding
- Minor maintenance activities such as joint sealing, crack sealing, chip sealing, and joint and panel repair

The following general assumptions and guiding principles were applied in the development of the implementation plan for system preservation projects:

- First overlay – 35 years after year of construction
- Second overlay – 15 years after first overlay for doweled concrete pavement (otherwise 12 years)
- Replacement – 15 years after second overlay
- Joint repair and sealing – 5 and 10 years after overlay projects
- Major bridge rehabilitation or replacement – generally assumed to occur in conjunction with roadway pavement replacement; for bridges not within expansion project limits, assumed to occur when the bridges are approximately 75 years old

The implementation plan for the system preservation projects is shown graphically later in this chapter. The system preservation projects were identified for a period beginning in the year 2025 and extending out to the year 2080 so as to

include the next total reconstruction of each of the freeway corridors. The total cost for the recommended system preservation projects within the Omaha metropolitan area freeway system for the years 2025 through 2080 is estimated to be \$1.87 Billion (B) in today's dollars and \$6.23B in Year of Expenditure dollars.

### Expansion Projects

Expansion projects are projects that are recommended to address the operational deficiencies of the freeway system that were identified in Phase 2. These projects would generally add capacity to the freeway corridors through the addition of mainline general purpose lanes and/or auxiliary lanes or would address weaving or other operational issues through the reconfiguration of interchanges and/or ramps.

The expansion projects developed during Phase 3 represent the incremental steps necessary to implement the overall recommended concepts presented in Chapter 3 and shown in the plans provided in **Appendix B** through **Appendix F**. These projects were developed jointly by NDOT and the Study Team.

The implementation plan for the expansion projects is shown graphically later in this chapter. Expansion project sheets, providing additional details about each expansion project, are also provided later in this chapter. For consistency with the system preservation projects, the expansion projects were identified for a period beginning in the year 2025 and extending out to the year 2080. However, all of the expansion projects necessary to implement the recommended concepts are assumed to be constructed prior to the year 2045. The total cost for the recommended expansion projects within the Omaha metropolitan area freeway system for the years 2025 through 2080 is estimated to be \$396M in today's dollars and \$633M in Year of Expenditure dollars.

### Implementation Plans

Two alternative implementation plans were developed in Phase 3. The first implementation plan, referred to as the Needs-Based Implementation Plan, provides a strategy focused on addressing the operational needs of the freeway system when the operational needs are expected to occur (or as soon as possible thereafter), without regard to funding capacity. The second implementation plan, referred to as the Constrained Implementation Plan, provides a more balanced strategy that considers other variables in addition to when the expansion projects are needed. These two implementation plans are discussed further in the following sections.

Both implementations plans are presented for the years 2025 through 2080. The year 2025 was identified as the first year for expansion projects based, in part, on the assumption that funding will not be available for these projects prior to the year 2025 and the assumption that design, environmental studies, and right-of-way acquisition will need to be performed prior to construction of these projects. Projects expected to occur prior to the year 2025 are shown. However, costs for these projects are not included because these projects are already programmed and/or are expected to be funded through the BNA.



### Needs-Based Implementation Plan

The Needs-Based Implementation Plan is shown in **Figure 4.1**. A legend for **Figure 4.1** is provided below:

First Overlay
Second Overlay
Full Reconstruction
Diamond Grinding
Minor System Preservation
Expansion Project (Not in Conjunction with a System Preservation Project)
Bridge Replacement Project

★ - Year of need, based on traffic operations, where applicable

In **Figure 4.1**, the projects are grouped first by corridor and then by type of project (that is, system preservation project versus expansion project). Information provided for each project includes the Project ID Number (S1-S32 for system preservation projects and E1-E33 for expansion projects), a brief project description, companion projects if a project is expected to occur simultaneously with another project, and the total cost of the project for the years 2025 through 2080 reported in today's dollars and Year of Expenditure dollars. The years are noted across the top and bottom of the figure. Yearly cost totals in today's dollars and Year of Expenditure dollars are reported across the bottom. The shading darkness of these cells increases as costs increase.

Within the schedule portion of the figure, the time frame and duration of each project is shown. The color of the bar indicates the type of project, as shown in the legend above. For expansion projects, the color of the bar indicates whether or not the project will coincide with a major system preservation project. If an expansion project does not coincide with an overlay, full reconstruction, or diamond grinding, it is shown in green. The cost of each project by year is noted in today's dollars. The year that the project is needed, based on traffic operations and where applicable, is noted with a star. This year of need was defined as the year when traffic operations will degrade to LOS 'E'.

As noted previously, the Needs-Based Implementation Plan focuses on when the expansion projects are needed based on traffic operations and without regard to funding capacity. Given that many of the expansion projects are needed today, these projects are generally front-loaded in the schedule. Several other expansion projects, although needed today, are shown later in the schedule if it was believed that other projects should be constructed first to maximize the efficiency of the system. All of the expansion projects are assumed to be completed prior to the year 2040.

The Needs-Based Implementation Plan results in yearly cost totals that range from \$27M to \$68M in today's dollars and from \$37 to \$87 in Year of Expenditure dollars between the years 2025 and 2040. Beyond the year 2040, only system preservation projects are expected to occur. Yearly costs for this period range from \$0 to \$104M in today's dollars and from \$0 to \$407 in Year of Expenditure dollars.

### Constrained Implementation Plan

The Constrained Implementation Plan is shown in **Figure 4.2**. The legend and format for the Constrained Implementation Plan are identical to that for the Needs-Based Implementation Plan discussed in the previous section and shown in **Figure 4.1**.

Recognizing that the Needs-Based Implementation Plan results in yearly costs that will likely exceed NDOT's funding capacity, the following considerations were provided by NDOT for the development of the Constrained Implementation Plan:

- **Funding capacity** – The Constrained Implementation Plan should consider the funding capacity of NDOT for any individual year, for any multi-year period, and for the overall program. The initial objective, as directed by NDOT, was to cap the costs for the years 2025 through 2030 in the range of \$25M to \$35M per year in today's dollars, for a total of \$150M using an average of \$30M per year. For the years 2030 through 2045, the objective was to cap the costs in the range of \$45M to \$65M per year in today's dollars, for a total of \$825M using an average of \$55M per year.
- **Combining system preservation and expansion projects** – The Constrained Implementation Plan should consider combining system preservation projects with expansion projects where it makes sense. This could be achieved by delaying or by advancing either type of project within any given freeway segment.
- **Operational considerations** – The Constrained Implementation Plan should consider when operational improvements are needed and the impacts of delaying these operational improvements (for example, Is LOS 'F' acceptable during peak hours? Is LOS 'F' acceptable for longer periods of the day?).
- **Limiting disruptions to the traveling public** – The Constrained Implementation Plan should consider the impacts of project construction on the users of the system (for example, Should there be a minimum number of years between major projects in any corridor? Once major construction is started in a corridor, should it be completed in a certain time frame?).
- **Prioritized corridors** – The Constrained Implementation Plan should give priority to certain freeway corridors over others. NDOT identified the I-80 corridor as the highest priority.
- **Core area versus fringe area projects** – The Constrained Implementation Plan should give priority to projects in the core areas of the freeway system over projects in the fringe areas of the freeway system.
- **Phased expansion projects** – The Constrained Implementation Plan should consider phasing the expansion projects where it makes sense to reduce the fiscal impacts and to minimize disruptions to the traveling public.

Compared to the Needs-Based Implementation Plan, the Constrained Implementation Plan generally spreads the expansion projects across the years 2025 through 2045. More consideration was also given to predecessor and successor relationships between expansion projects. Additional information regarding these relationships is included in the expansion project sheets provided later in this chapter. In some cases, these relationships resulted in expansion projects being scheduled much longer after the project is needed based on operations. However, all of the expansion projects are assumed to be completed by the year 2043.

The Constrained Implementation Plan results in yearly cost totals that range from \$25M to \$44M in today's dollars and from \$32M to \$60M in Year of Expenditure dollars between the years 2025 and 2030. Yearly cost totals range from \$23M to \$70M in today's dollars and from \$49M to \$116M in Year of Expenditure dollars between the years 2030 and 2045. Beyond the year 2045, only system preservation projects are expected to occur. Yearly costs for this period range from \$0M to \$104M in today's dollars and from \$0 to \$407M in Year of Expenditure dollars.

These yearly costs generally fall within the assumed funding capacities provided by NDOT. For the years 2025 through 2030, the total cost of the Constrained Implementation Plan is \$158M in today's dollars, which is slightly over the cap of \$150M provided by NDOT. For the years 2030 through 2045, the total cost of the Constrained Implementation Plan is \$703M in today's dollars, which is considerably below the cap of \$825M. For the years 2025 through 2045, the total cost of the Constrained Implementation Plan is \$861M in today's dollars, which is considerably below the cap of \$975M.



INTERSTATES

Table of Interstate projects (S1-S24, E1-E19) including System Preservation, Expansion, and System Interchanges. Columns include ID, Project Name, Companion Project, Current/Future Cost (\$M), YR, and Yearly funding from 17 to 80.

Summary rows for Interstates showing Current Interstate Total (1.73 B \$M) and Future Interstate Total (5.55 B \$M). Includes monthly breakdowns for current and future years.

FREEWAYS

Table of Freeway projects (S25-S33, E20-E33) including System Preservation, Expansion, and Dodge. Columns include ID, Project Name, Companion Project, Current/Future Cost (\$M), YR, and Yearly funding from 17 to 80.

Summary rows for Freeways showing Current Freeway Total (0.54 B \$M) and Future Freeway Total (1.32 B \$M). Includes monthly breakdowns for current and future years.

Figure 4.2. Constrained Implementation Plan

## Expansion Project Sheets

Expansion project sheets that provide additional details about each expansion project are provided beginning on the next page. The expansion project sheets include the following, where applicable:

- A location map that highlights the expansion area as well as bridge impacts for each expansion project
- A detailed description of each project
- Year of need based on operations
- Year of implementation based on the Constrained Implementation Plan
- A lane schematic
  - Where applicable, a schematic is provided for projects that include widening of the freeway mainline.
  - These schematics depict the existing freeway configuration and the proposed expansion project, which is shown in yellow in each schematic.
  - If any expansion projects may occur in the interim, or are closely tied with the expansion project in focus, the secondary projects are shown in a green, blue, or pink color and called out with their project ID.
- Correlation with other expansion projects
- Potential overlap with system preservation projects
- Potential impacts on bridges
- Breakdown of costs by mainline paving, interchange work, bridge, walls, right-of-way, and miscellaneous
- Total project cost
  - If unrelated to a system preservation project, the total project cost is the same as the value provided in **Figure 4.2** for the Constrained Implementation Plan.
  - If coordinated with a system preservation project, the total project cost is provided with and without system preservation costs.

A directory of the 33 expansion project sheets (E1 - E33) is shown in **Table 4.1**.

**Table 4.1. Project Sheet Directory**

Project ID	Project Name	See Page
E1	I-80 WB Expansion: Q Street to Giles Road	27
E2	I-80 WB Mainline Expansion with N-50 Exit Ramp Capacity Expansion	28
E3	I-80 Interchange Addition: 186 <sup>th</sup> Street	29
E4	I-80 Interchange Expansion: N-370 DDI / I-80 EB Mainline Expansion: N-370 to N-50	30
E5	I-80 Interchange Expansion: N-50 DDI	31
E6	I-80 Interchange Expansion: Giles Road	32
E7	I-80 Mainline Expansion: I-680 to 50 <sup>th</sup> Street	33
E8	I-80 Interchange Modification: 42 <sup>nd</sup> Street / I-80 Mainline Expansion: 50 <sup>th</sup> Street to 40 <sup>th</sup> Street	34
E9	I-80 Mainline Expansion: N-50 to ILQ CD Road	35
E10	I-80 Bridge Replacements: L and I Streets / I-80 Interchange Expansion: L Street DDI	36
E11	I-80 WB Mainline Expansion: I Street to Q Street	37
E12	I-80 EB Mainline Expansion: Q Street to I-680	38
E13	I-80 WB Mainline Expansion: US-75 to 42 <sup>nd</sup> Street	39
E14	I-480 Bridge Replacements: Woolworth Avenue, Leavenworth Street, and St. Mary's Avenue	40
E15	I-480 Mainline Expansion: I-80 to Harney Street	41
E16	I-680 Mainline Expansion: Pacific Street to West Dodge Road	42
E17	I-680 Mainline Expansion: Fort Street to Blair High Road	43
E18	I-680 Mainline Expansion: I-80 to Pacific Street	44
E19	I-680 Mainline Expansion: West Dodge Road to West Maple Road	45
E20	US-75 NB Mainline Expansion: Chandler Road to F Street	46
E21	US-75 Mainline Expansion: N-370 to Chandler Road	47
E22	Dahlman Avenue Expansion: F Street to L Street with Dahlman Avenue Rail Bridge Replacement	48
E23	US-75 Bridge Replacements: Q Street, L Street, and F Street	49
E24	US-75 Mainline Expansion: Q Street to I-80	50
E25	US-75 Mainline Expansion: Chandler Road to Q Street	51
E26	US-75 Mainline Expansion: N-370 to Chandler Road	52
E27	US-75 Interchange Expansion: Cornhusker Road DDI	53
E28	US-6 WB Mainline Expansion: 132 <sup>nd</sup> Street to 144 <sup>th</sup> Street	54
E29	US-6 EB Mainline Expansion: 137 <sup>th</sup> Street to 132 <sup>nd</sup> Street	55
E30	US-6 Interchange Expansion: 192 <sup>nd</sup> Street DDI	56
E31	US-6 Mainline Expansion: 168 <sup>th</sup> Street to 108 <sup>th</sup> Street	57
E32	US-6 Mainline Expansion: 204 <sup>th</sup> Street to 168 <sup>th</sup> Street	58
E33	I-680 / US-6 System Interchange Expansion: WB Weave Improvements	59



# E1

## I-80 WB Expansion: Q Street to Giles Road MP 444.34 – MP 442.75

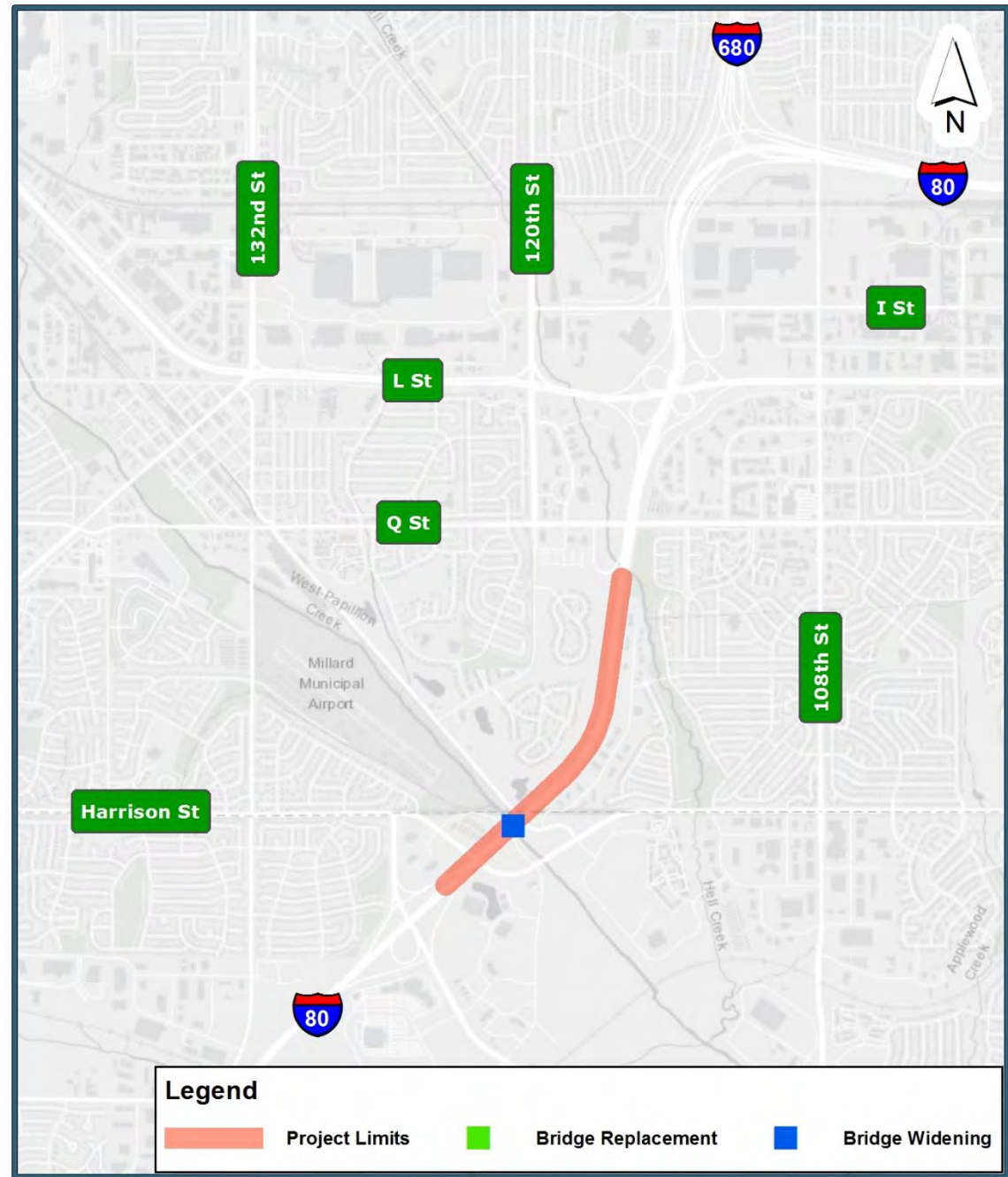

**Description**

This project adds an auxiliary lane from the end of the WB ILQ CD Road to the WB Giles Road exit ramp with a two-lane exit ramp (with lane balance).

**Year of Need**

- The auxiliary lane between the ILQ CD road and Giles Road is a need in 2019.

**Year of Implementation**

- 2025

**Implementation Considerations**

- E1 occurs at the same time as diamond grinding system preservation activities – S4.
- E1 impacts one bridge (S080 44342) that needs to be widened to accommodate one additional WB lane. Piers at S080 44342 were constructed for future bridge widening associated with E1 during a previous expansion project in the area.

**Constructability**

- The WB I-80 cross section can be widened without full-time lane closures.
- Off-peak ramp closures may occur at Giles Road and the ILQ CD road ramp.

**Cost Breakdown (Current Year Dollars)**

The following table includes the costs (in \$ Millions) associated with the expansion:

Total	Pavement	Bridges	Walls / Barriers	Right-of-Way	Miscellaneous
<b>\$5.01</b>	\$1.67	\$0.99	\$0.25	-	\$2.10*

\* Miscellaneous costs include \$2.10M for premium costs associated with grading and drainage on the west side of I-80.

Total cost with diamond grinding on I-80 between Q Street and Giles Road (S4): \$5.53M

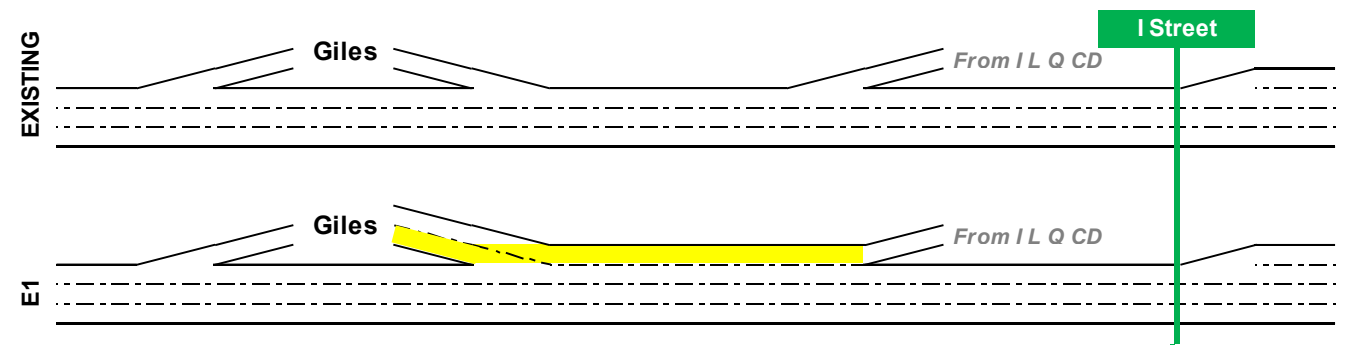

**E2** I-80 WB Mainline Expansion with N-50 Exit Ramp Capacity Expansion  
MP 441.94 – MP 440.66

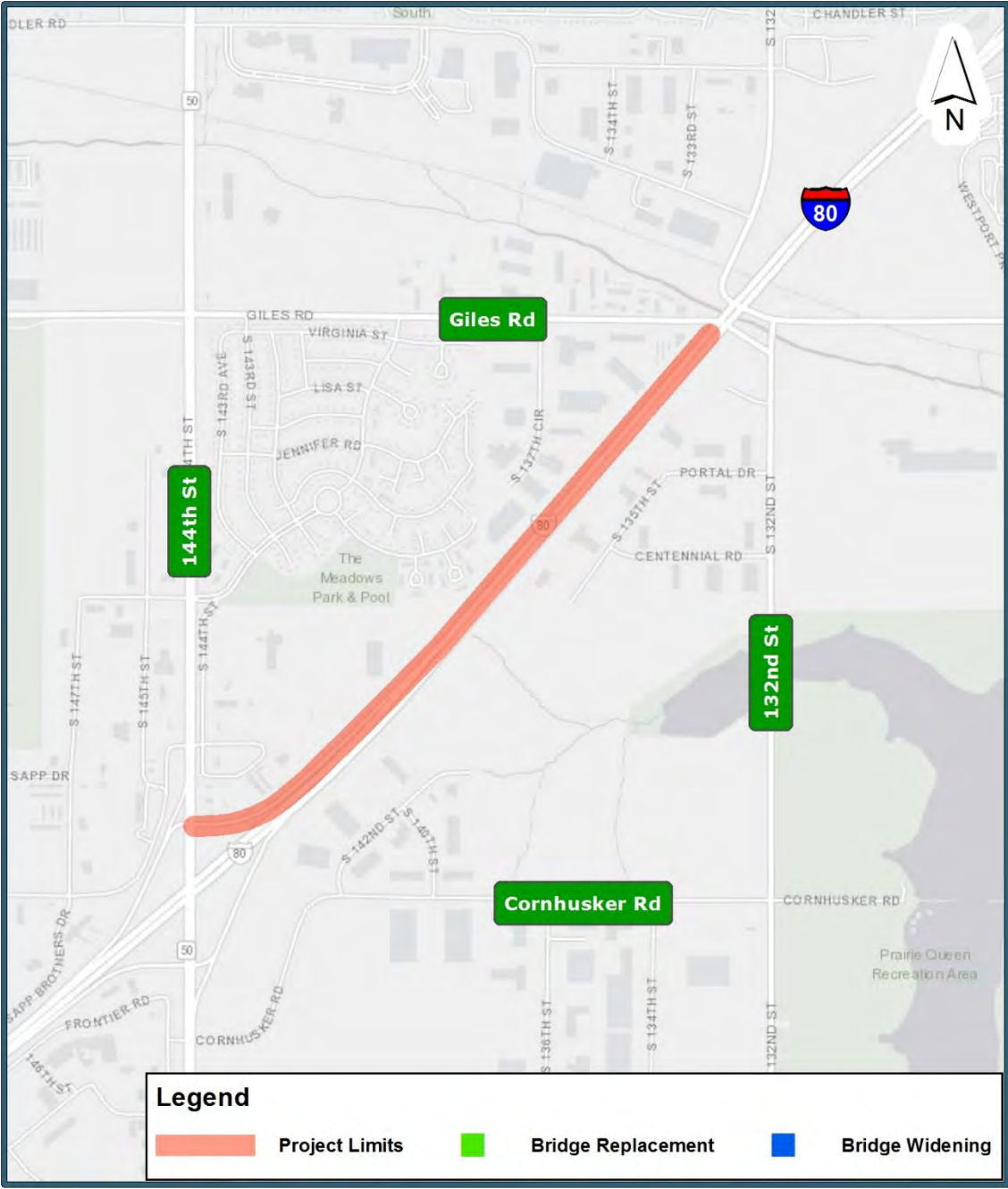

**Description**

This project adds capacity on the WB I-80 exit ramp at N-50 and on WB I-80 as a lengthened deceleration lane. The project is intended to extend the life of the N-50 interchange by providing additional queue storage to minimize backups onto the WB I-80 mainline.

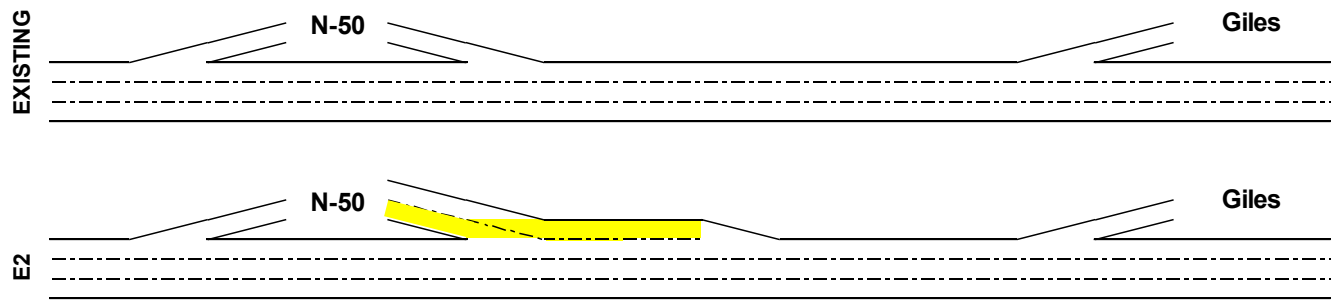

**Year of Need**

- The N-50 interchange is an operational need in 2019.

**Year of Implementation**

- 2026

**Implementation Considerations**

- E2 does NOT occur at the same time as any major system preservation activities.
- E2 does NOT impact the Giles Road bridge by adding the deceleration lane SW of bridge S080 44207.

**Constructability**

- The WB I-80 mainline cross section can be widened without full-time lane closures.
- Lane reductions on the WB I-80 exit ramp at N-50 may occur during expansion with mostly off-peak closures.

**Cost Breakdown (Current Year Dollars)**

The following table includes the costs (in \$ Millions) associated with the expansion:

Total	Pavement	Bridges	Walls / Barriers	Right-of-Way	Miscellaneous
\$1.57	\$1.48	-	-	-	\$0.09*

\* Miscellaneous costs include \$0.09M for signal costs at the WB ramp terminal at N-50.





# E3

## I-80 Interchange Addition: 186<sup>th</sup> Street MP 435.72 – MP 436.38

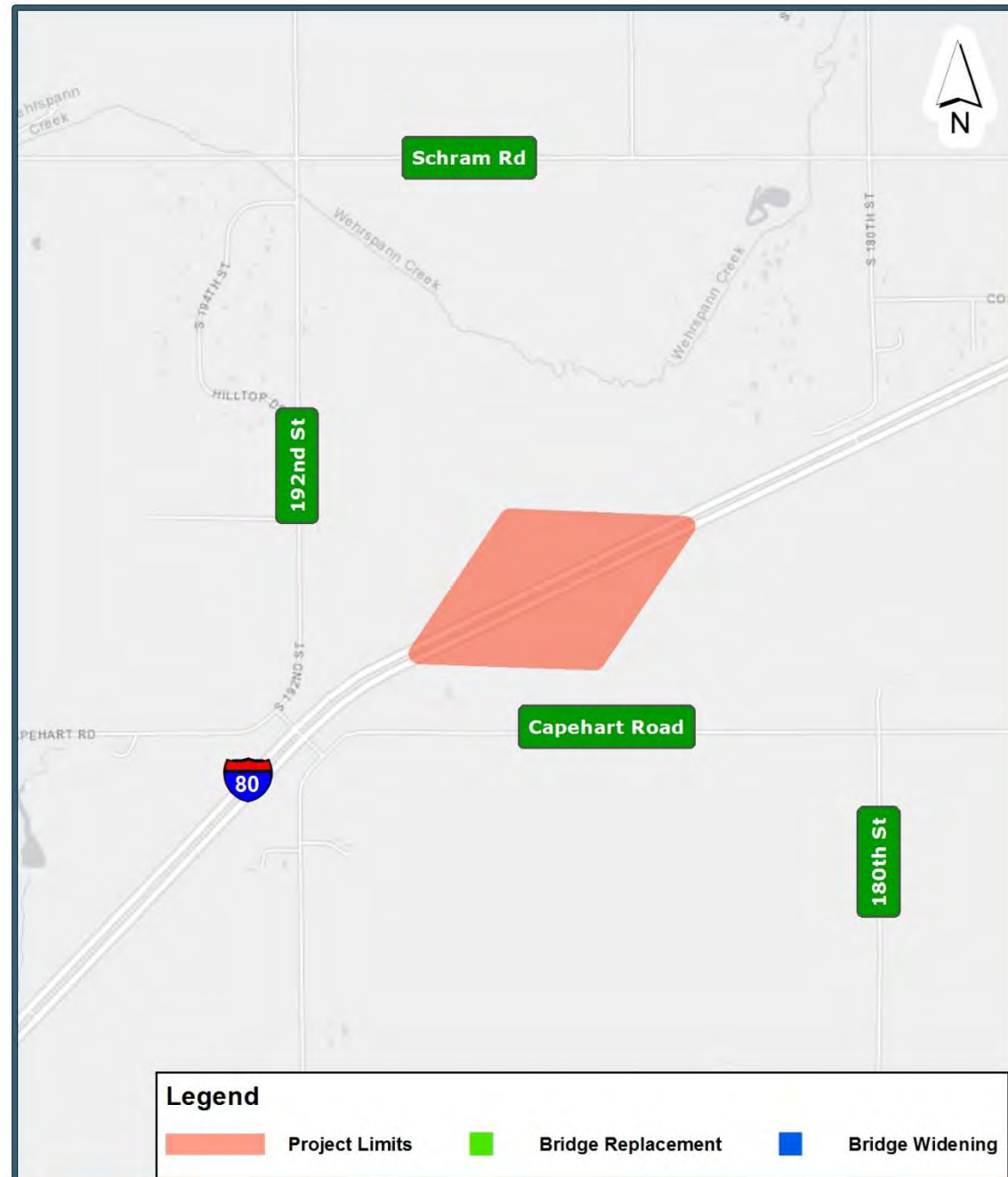

### Description

This project adds a new interchange at 186<sup>th</sup> Street, between 180<sup>th</sup> Street and 192<sup>nd</sup> Street.

### Year of Need

- The year of need is not applicable. This project is a potential new interchange.

### Year of Implementation

- 2025–2026

### Implementation Considerations

- E3 does NOT occur at the same time as any major system preservation activities.
- E3 would require a new structure to be built for the interchange, but the interchange would NOT impact any existing structures directly. The project may require improved east-west connectivity that may impact other bridges over I-80 (that is, Schram Road and Capehart Road bridges).
- E3 would improve adjacent interchange operations through traffic diversion from the N-31 and N-370 interchanges.
  - If constructed with improved east-west connectivity, the 186<sup>th</sup> Street interchange would eliminate the need for a DDI reconfiguration at the N-31 interchange.
  - The N-370 interchange year of need (2019) does not change due to traffic diversion.

### Constructability

- A majority of construction activities will occur outside of the I-80 mainline and will not impact I-80 traffic.
- The 186<sup>th</sup> Street bridge construction may require traffic shifts and/or temporary lane closures for the I-80 mainline.
- If constructed before the N-370 interchange expansion (E4) and the N-370 six-lane expansion (BNA project), the 186<sup>th</sup> Street interchange would provide improve MOT during construction of improvements in the N-370 corridor west of I-80.

### Cost Breakdown (Current Year Dollars)

The following table includes the costs (in \$ Millions) associated with the expansion:

Total	Pavement	Bridges	Walls / Barriers	Right-of-Way	Miscellaneous
TBD*	Costs to be Determined By Others				

\* It is assumed that NDOT will not be responsible for costs associated with the 186<sup>th</sup> Street Interchange.

**E4** I-80 Interchange Expansion: N-370 DDI / I-80 EB Mainline Expansion: N-370 to N-50 MP 439.22 – MP 440.23

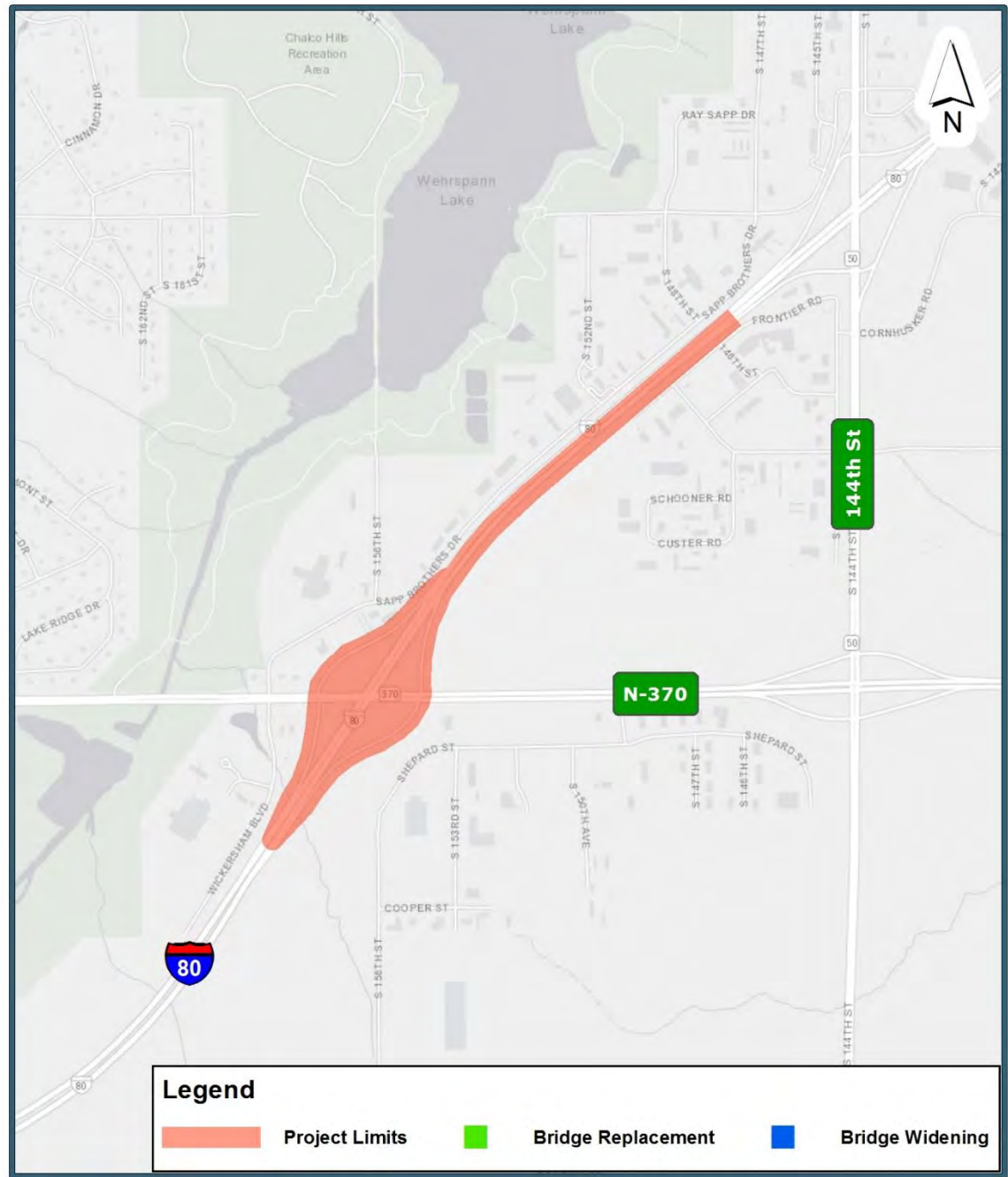

**Description**

This project expands the existing diamond configuration to a DDI at the N-370 interchange. This project also includes the expansion from a one-lane EB entrance ramp to a two-lane EB entrance ramp. On EB I-80, three lanes from EB I-80 will combine with two lanes from N-370 to create five lanes total. The five-lane section will split to three and two (three lanes to EB I-80 and two lanes to N-50). No lane balance will be provided at the N-50 exit ramp.

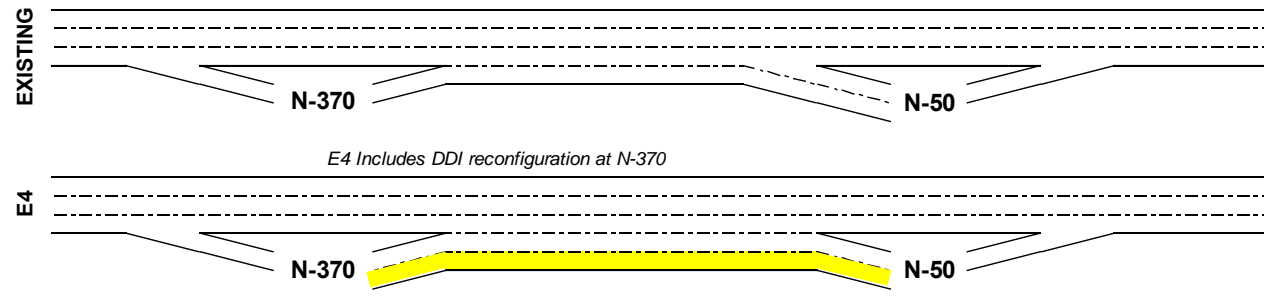

**Year of Need**

- The N-370 interchange is an operational need in 2019.

**Year of Implementation**

- 2027–2028

**Implementation Considerations**

- E4 does NOT occur at the same time as any major system preservation activities.
- E4 does NOT impact any existing structures.
- E4 needs to be coordinated with the N-370 six-lane expansion from Gretna to US-75.

**Constructability**

- A majority of the interchange reconstruction activities will occur outside of the I-80 mainline and will not impact mainline traffic.
- Complex ramp terminal staging at N-370 will be required to maintain full access at the N-370 interchange during reconstruction. Periods of closure for specific ramp movements are possible.
- The completion of the 186<sup>th</sup> Street interchange (E3) prior to N-370 reconstruction will improve MOT, allowing users to and from the Gretna area to avoid congestion during significant lane reduction stages.
- The EB I-80 mainline cross section can be widened without full-time lane closures.

**Cost Breakdown (Current Year Dollars)**

The following table includes the costs (in \$ Millions) associated with the expansion:

Total	Pavement	Bridges	Walls / Barriers	Right-of-Way	Miscellaneous
\$5.40	\$4.80	-	-	-	\$0.60*

\* Miscellaneous costs include \$0.60M for signal costs at the N-370 ramp terminals.



# E5

## I-80 Interchange Expansion: N-50 DDI MP 440.23 – MP 440.10

### Description

This project's primary purpose is to expand the existing diamond configuration to a DDI at the N-50 interchange. This project's secondary purpose is to provide enough lateral clearance for four basic lanes in each direction under the N-50 bridge. Localized widening to a six-lane facility on N-50 between Meadows Boulevard (to the north) and Prairie Corners Road (to the south) is recommended to minimize the potential for arterial backups impacting N-50 interchange operations but is not included in the cost breakdown.

### Year of Need

- The N-50 interchange is an operational need in 2019.
- The additional basic lane under N-50 is needed in 2030.

### Year of Implementation

- 2031–2032

### Implementation Considerations

- E5 does NOT occur at the same time as any major system preservation activities.
- E5 would replace the existing bridge (S080 44066) due to the age and condition of the structure, and because the existing structure does not provide enough lateral clearance for four lanes and 12-foot-wide shoulders.

### Constructability

- A majority of the interchange reconstruction activities will occur outside of the I-80 mainline and will not impact mainline traffic.
- Complex ramp terminal staging along N-50 would be needed to maintain full access at the N-50 interchange during reconstruction. Periods of closure for specific ramp movements are possible.
- The existing bridge will be replaced with two structures offset to either side of the existing bridge to minimize traffic impacts on N-50 and access to ramps during construction.
- N-50 bridge reconstruction may require traffic shifts or lane closures for the I-80 mainline.

### Cost Breakdown (Current Year Dollars)

The following table includes the costs (in \$ Millions) associated with the expansion:

Total	Pavement	Bridges	Walls / Barriers	Right-of-Way	Miscellaneous
\$18.88	\$8.21	\$6.44	\$0.83	\$0.80	\$2.60*

\* Miscellaneous costs include \$2.00M for premium costs associated with grading and utility relocation at N-50 (as directed by NDOT), and \$0.60M for signal costs at the N-50 ramp terminals.

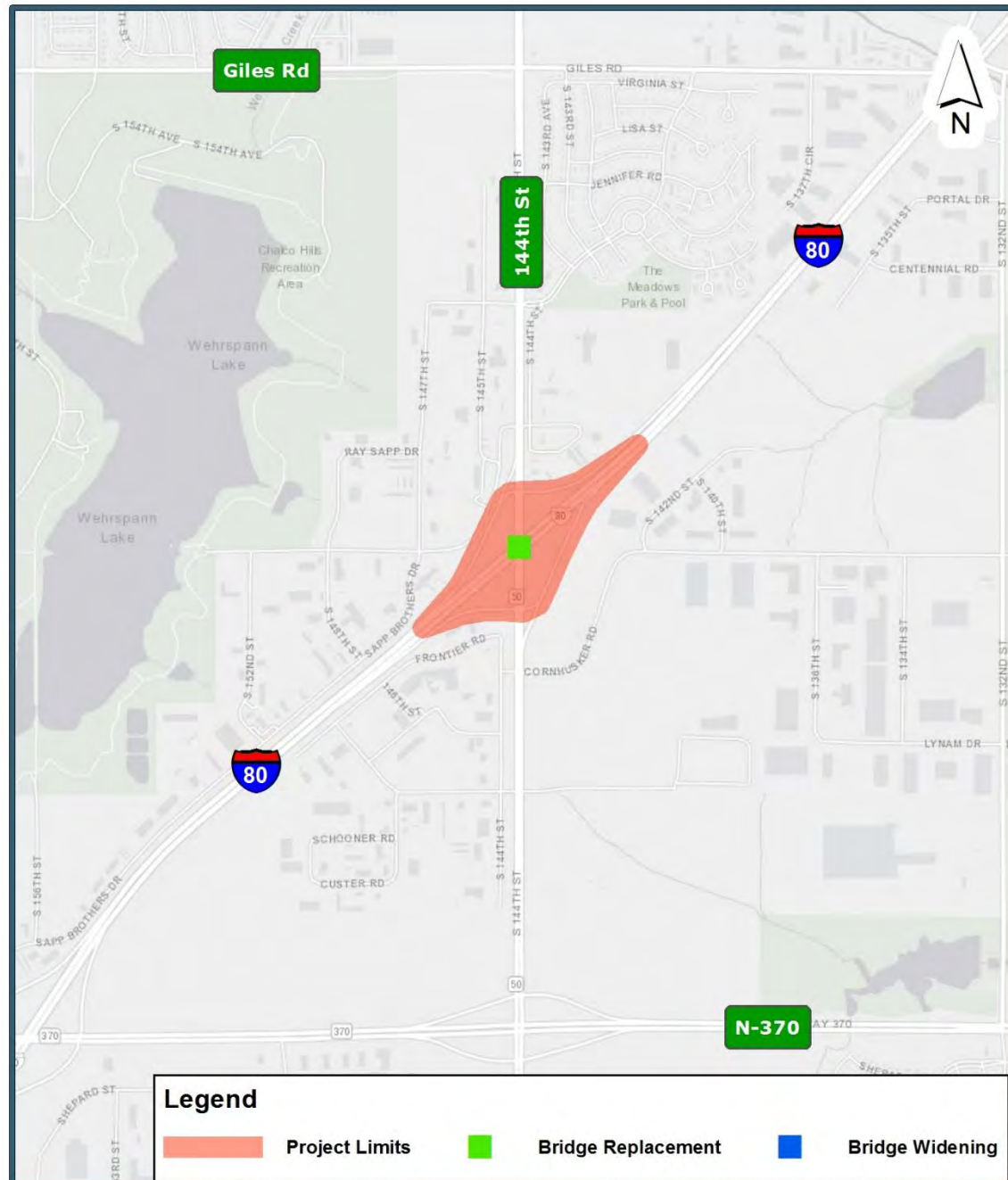

**E6** I-80 Interchange Expansion: Giles Road  
MP 442.56 – MP 443.25

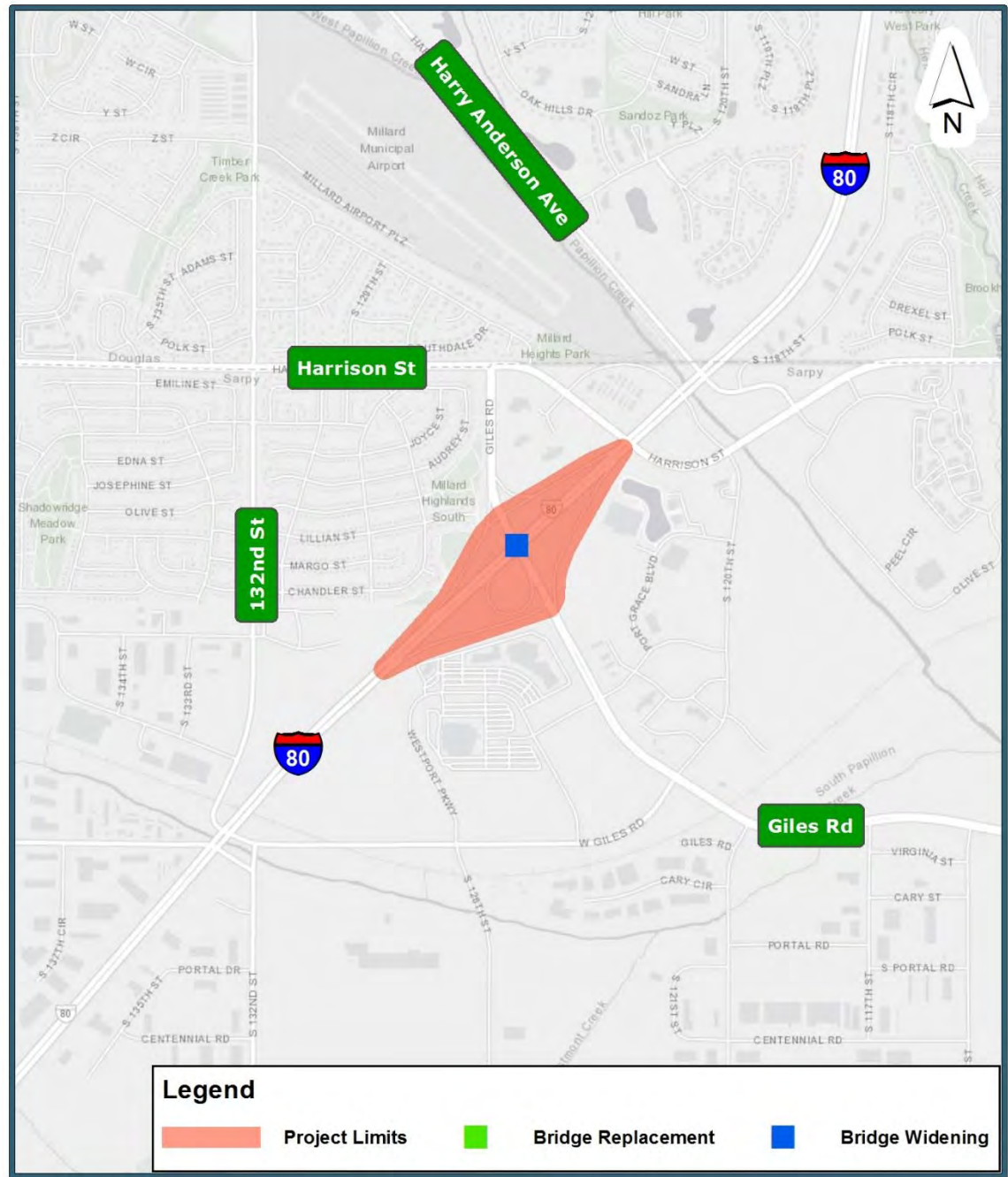

**Description**

This project expands the existing interchange configuration by adding one lane in each direction on Giles Road through the interchange. This project also provides an additional SB lane approaching I-80 to allow a “free right” for users destined for WB I-80. A two-lane EB entrance ramp would be provided to improve NB lane utilization on Giles Road approaching I-80. The two-lane EB entrance ramp would taper to one lane on the entrance ramp prior to I-80. Localized widening to a six-lane facility on Giles Road between Harrison Street (to the north) through Southport Parkway (to the south) is recommended to minimize the potential for arterial backups impacting Giles Road interchange operations but is not included in the cost breakdown.

**Year of Need**

- The Giles Road interchange is an operational need in 2019.

**Year of Implementation**

- 2032–2033

**Implementation Considerations**

- E6 does NOT occur at the same time as any major system preservation activities.
- E6 would widen the existing bridge (S080 44292) to provide enough lateral clearance to fit a six-lane (three lanes in each direction) section on Giles Road.

**Constructability**

- A majority of the interchange reconstruction activities will occur outside of the I-80 mainline and will not impact I-80 mainline traffic.
- Lane reductions on Giles Road through the interchange area may occur during expansion. It should be feasible to limit most of the closure to off-peak times.

**Cost Breakdown (Current Year Dollars)**

The following table includes the costs (in \$ Millions) associated with the expansion:

Total	Pavement	Bridges	Walls / Barriers	Right-of-Way	Miscellaneous
\$2.07*	\$1.00	\$1.07	-	-	-

\* The total of \$2.07M accounts the portion of the interchange expansion assumed to be covered by NDOT.



# E7

## I-80 Mainline Expansion: I-680 to 50<sup>th</sup> Street MP 446.02 – MP 451.00

### Description

This project adds two basic freeway lanes on I-80 between I-680 and 50<sup>th</sup> Street. Auxiliary lanes would be retained between service interchanges. This project includes the reconstruction of the parclo interchanges at 84<sup>th</sup> Street, 72<sup>nd</sup> Street, and 60<sup>th</sup> Street to fit the additional mainline lanes. This project connects with the expansion between 50<sup>th</sup> Street and 42<sup>nd</sup> Street (E8, shown in blue).

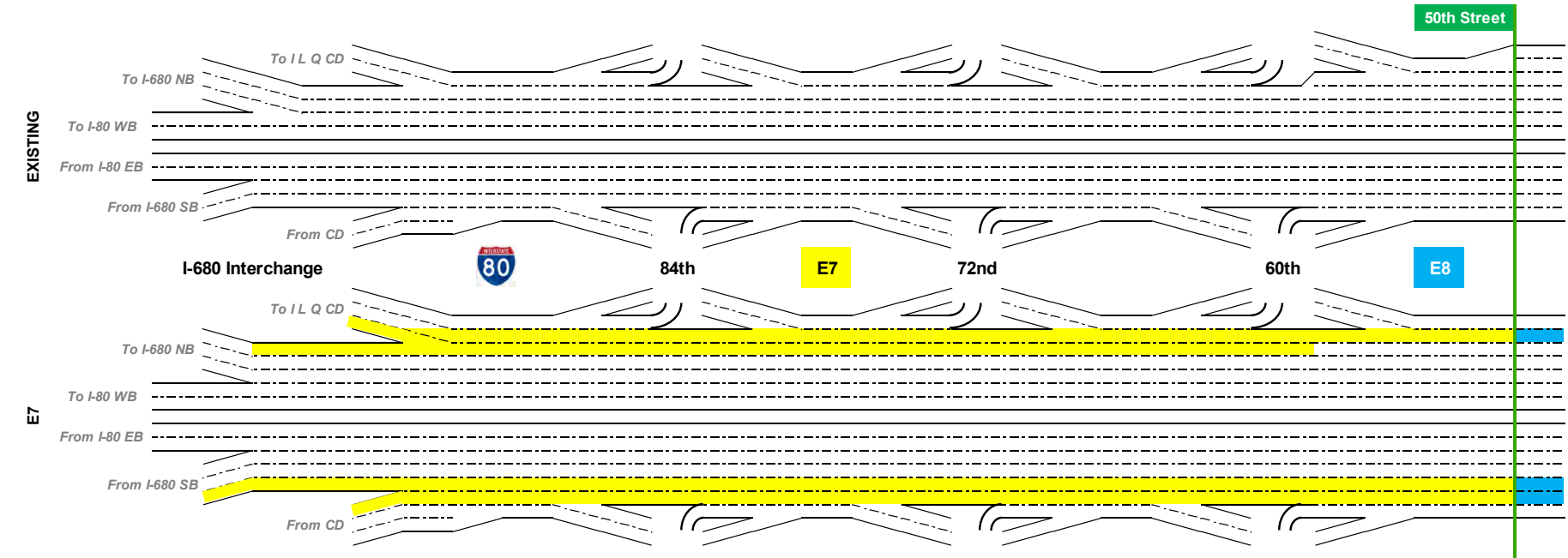

### Implementation Considerations

- E7 occurs at the same time as the first overlay – S6.
- E7 would widen the following 11 bridges to provide enough lateral clearance for two additional lanes with full 12-foot-wide shoulders: S080 44827L, S080 44827R, S080 44846L, S080 44846R, S080 44927L, S080 44927R, S080 44984, S080 45028L, S080 45028R, S080 45103L, and S080 45103R.
- E7 would replace the following bridges:
  - S080 44725 to provide enough lateral clearance for two additional lanes with full 12-foot-wide shoulders.
  - S080 44846A to provide adequate WB exit ramp geometrics at 84<sup>th</sup> Street.

### Constructability

- The I-80 mainline cross section can be widened without full-time lane closures.
- Ramp modifications to accommodate mainline widening through the parclos may require a combination of ramp closures, lane restrictions, temporary surfacing, and traffic shifts. Closures of less than a construction season duration should be achievable at individual ramps.
- Bridge reconstruction at 96<sup>th</sup> Street may require lane closures and/or traffic shifts for the I-80 mainline.
- Bridge replacement at the WB 84<sup>th</sup> Street exit ramp will require full closure of the WB exit ramp.

### Cost Breakdown (Current Year Dollars)

The following table includes the costs (in \$ Millions) associated with the expansion:

Total	Pavement	Bridges	Walls / Barriers	Right-of-Way	Miscellaneous
\$65.89	\$30.58	\$15.52	\$5.32	\$6.47	\$8.00*

\* Miscellaneous costs include \$8.00M for drainage costs associated with the two-lane expansion.

Total cost with an overlay on I-80 between I-680 and 50<sup>th</sup> Street (S6): \$92.04M

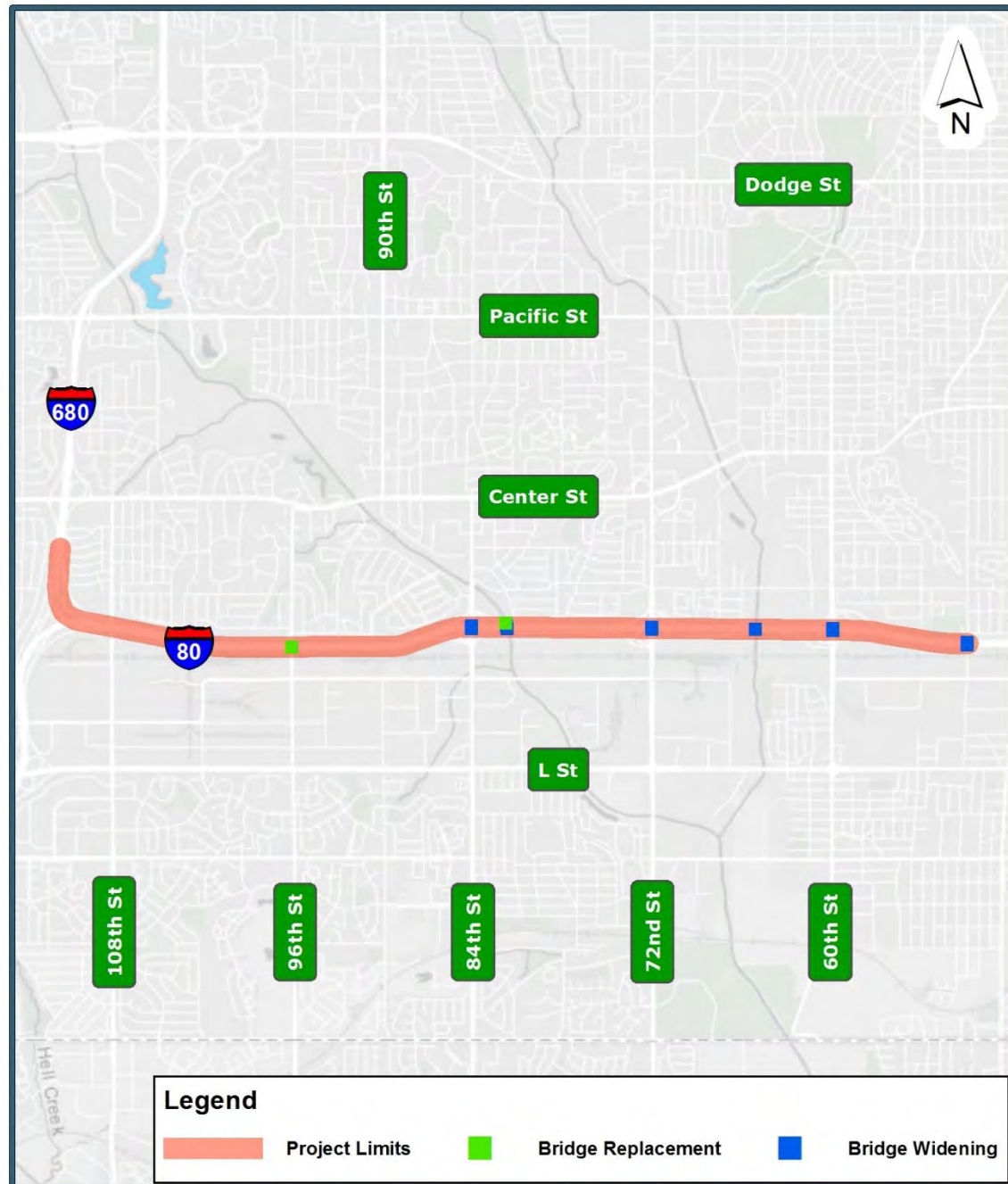

Year of Need	Year of Implementation
One basic lane (five lanes total + Aux) is needed in 2019. Two basic lanes (six lanes total + Aux) are needed in 2031.	2031–2035

**E8** I-80 Interchange Modification: 42<sup>nd</sup> Street / I-80 Mainline Expansion: 50<sup>th</sup> Street to 40<sup>th</sup> Street  
MP 451.00 – MP 452.12

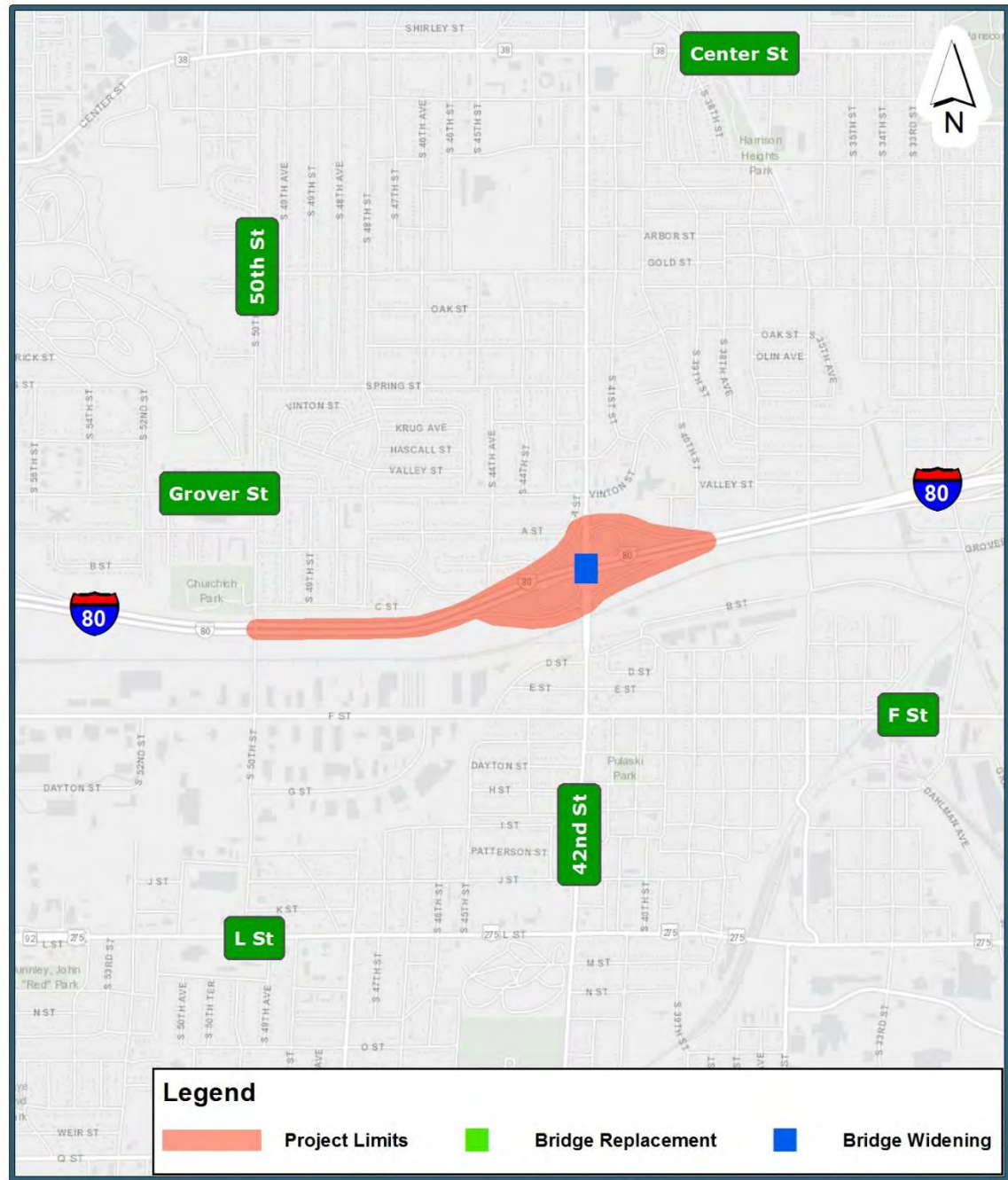

**Description**

This project (shown in yellow) completes the two-lane expansion of I-80 to the west from I-680 to 50<sup>th</sup> Street (E7, shown in green). It also connects the two-lane flyover expansion from NB US-75 to WB I-80 (E13, shown in blue and E24, shown in pink) with E7. It includes the modification of the SB to EB loop ramp to allow the ramp to merge onto I-80 prior to the merge of the NB to EB directional ramp.

**Year of Need**

- The operational need is dependent on the expansion of I-80 to the west. Once the two-lane expansion occurs for E7, there will be an immediate need to complete E8.

**Year of Implementation**

- 2035–2036

**Implementation Considerations**

- E8 does NOT occur at the same time as any major system preservation activities.
- E8 would widen the 42<sup>nd</sup> Street bridges (S080 45180L and S080 45180R) to provide enough lateral clearance for one additional lane over 42<sup>nd</sup> Street.

**Constructability**

- The I-80 mainline cross section can be widened without full-time lane closures.
- Ramp modifications to accommodate the mainline widening and the reconfiguration of the loop ramps and the EB exit ramp may require ramp closures of less than a construction season duration and a combination of temporary surfacing, ramp lane restrictions, and traffic shifts.
- Bridge widening on I-80 over 42<sup>nd</sup> Street may involve lane closures or restrictions on 42<sup>nd</sup> Street. Impacts on 42<sup>nd</sup> Street should be mostly limited to off-peak periods.

**Cost Breakdown (Current Year Dollars)**

The following table includes the costs (in \$ Millions) associated with the expansion:

Total	Pavement	Bridges	Walls / Barriers	Right-of-Way	Miscellaneous
\$8.82	\$6.57	\$0.86	\$0.99	\$0.13	\$0.27*

\* Miscellaneous costs include \$0.27M for signal costs at the 42<sup>nd</sup> Street ramp terminals.

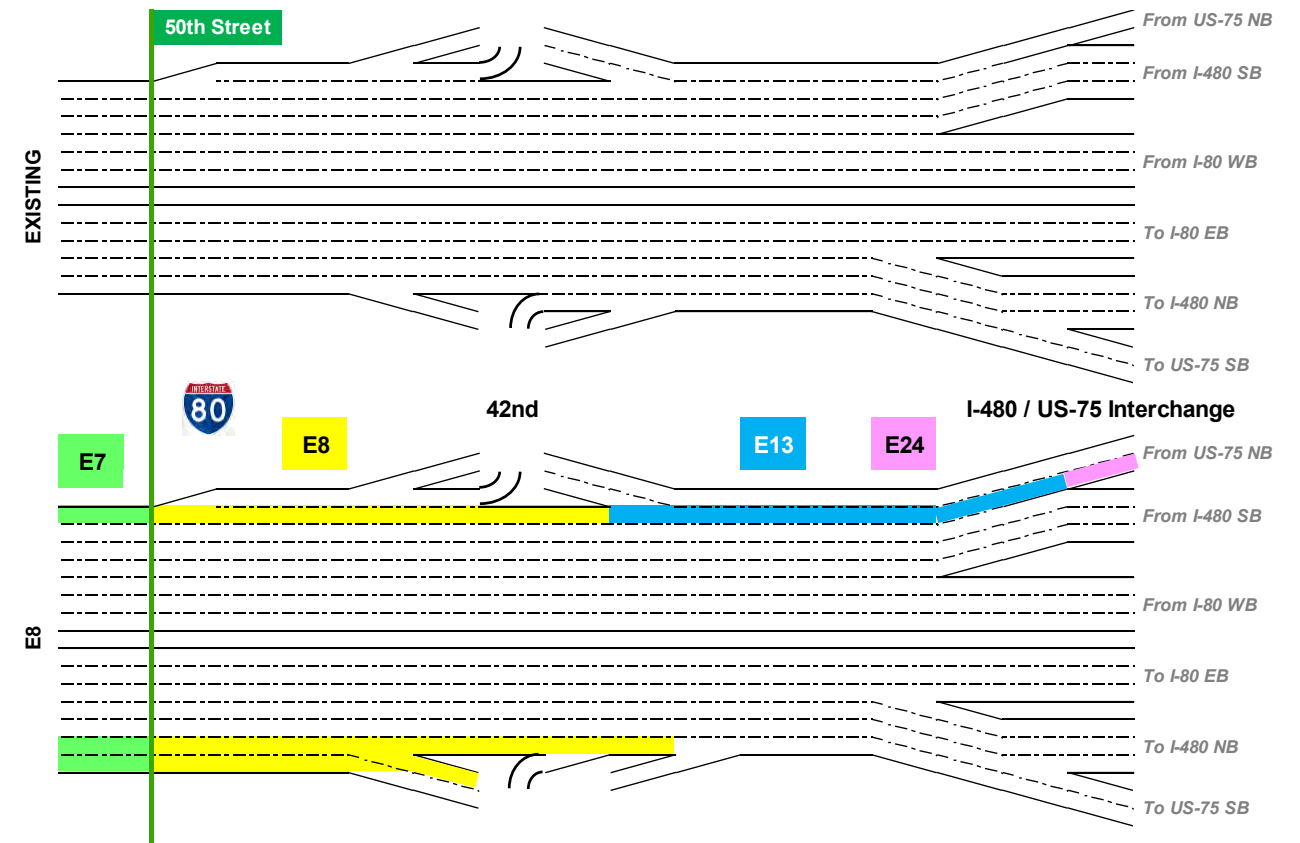



# E9

## I-80 Mainline Expansion: N-50 to ILQ CD Road MP 440.23 – MP 444.45

### Description

This project (shown in yellow) completes the four-lane basic freeway section of I-80 (in each direction) from the I-680 interchange through the N-50 interchange. Auxiliary lanes (five lanes total) are provided between ILQ and Giles Road, and between Giles Road and N-50. The figure below details the four expansion projects that connect with expansion from N-50 to the ILQ CD road (E1, shown in blue; E4, shown in green; E11, shown in red; and E12, shown in pink).

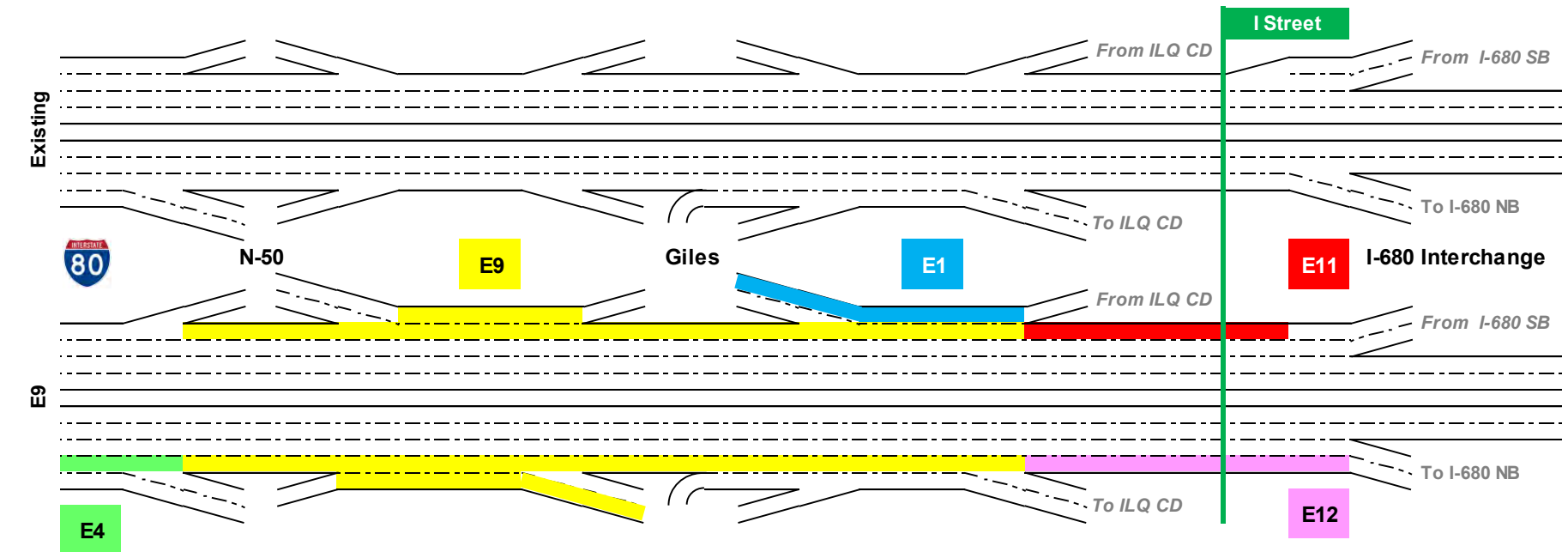

### Implementation Considerations

- E9 occurs at the same time as the first overlay – S3.
- E9 would widen bridges at two locations (S080 44207 and S080 44342) to provide enough lateral clearance for one or two additional lanes.
- The EB portion of E9 occurs at the same time as E12.
- The WB portion of E9 occurs at the same time as E11.

### Constructability

- The I-80 mainline cross section can be widened without full-time lane closures.
- A combination of off-peak ramp closures, lane restrictions, and traffic shifts may occur at the Giles Road and N-50 ramps. Individual ramp impacts should be of less than a construction season duration.

### Cost Breakdown (Current Year Dollars)

The following table includes the costs (in \$ Millions) associated with the expansion:

Total	Pavement	Bridges	Walls / Barriers	Right-of-Way	Miscellaneous
\$23.07	\$15.35	\$7.46	\$0.26	-	-

Total cost with an overlay on I-80 between N-370 and Giles (S3): \$36.36M

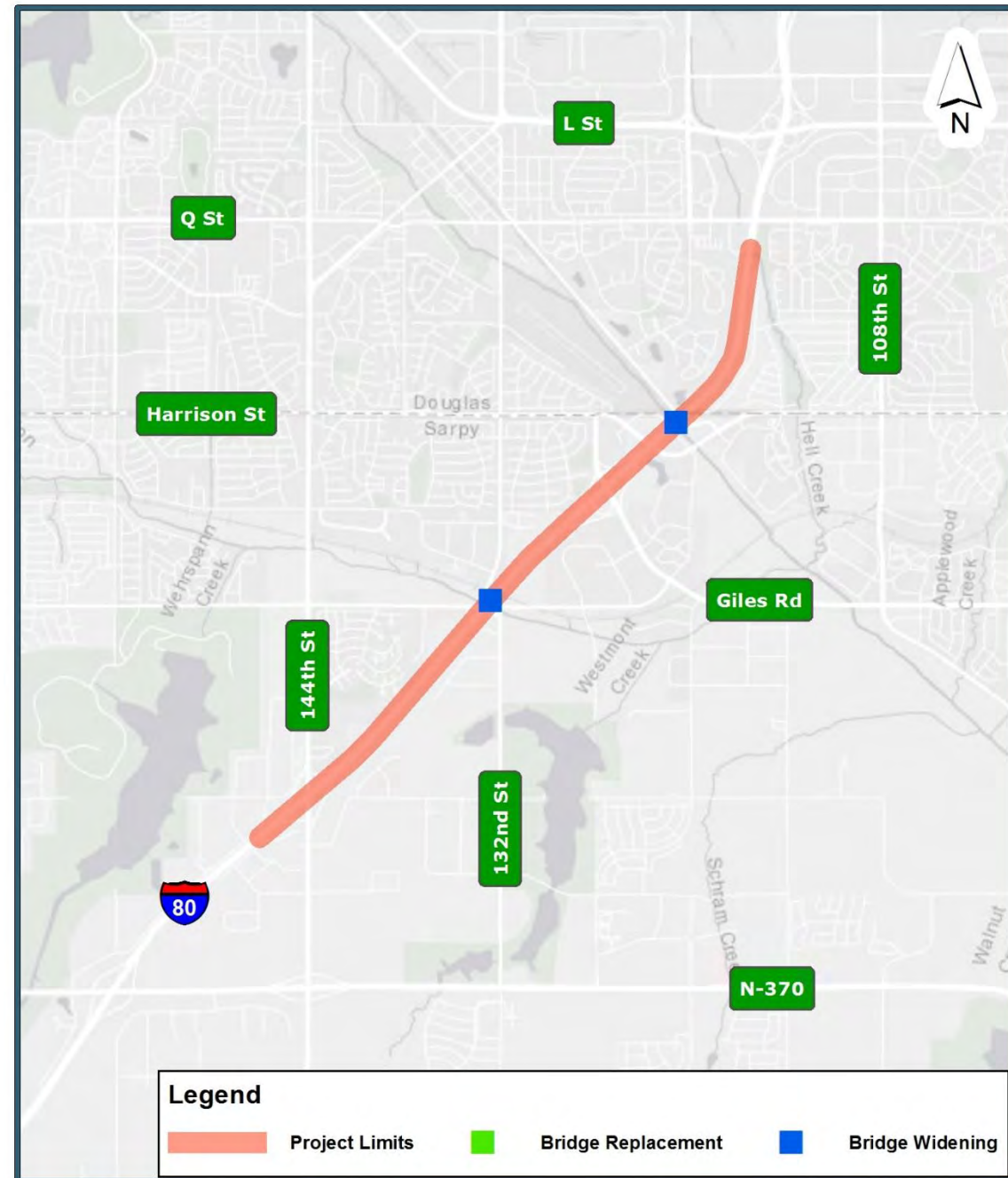

Year of Need	Year of Implementation
The mainline operational need for four basic freeway lanes occurs in 2030.	2039-2043

**E10** I-80 Bridge Replacements: L and I Streets / I-80 Interchange Expansion: L Street DDI  
MP 444.82 – MP 445.37

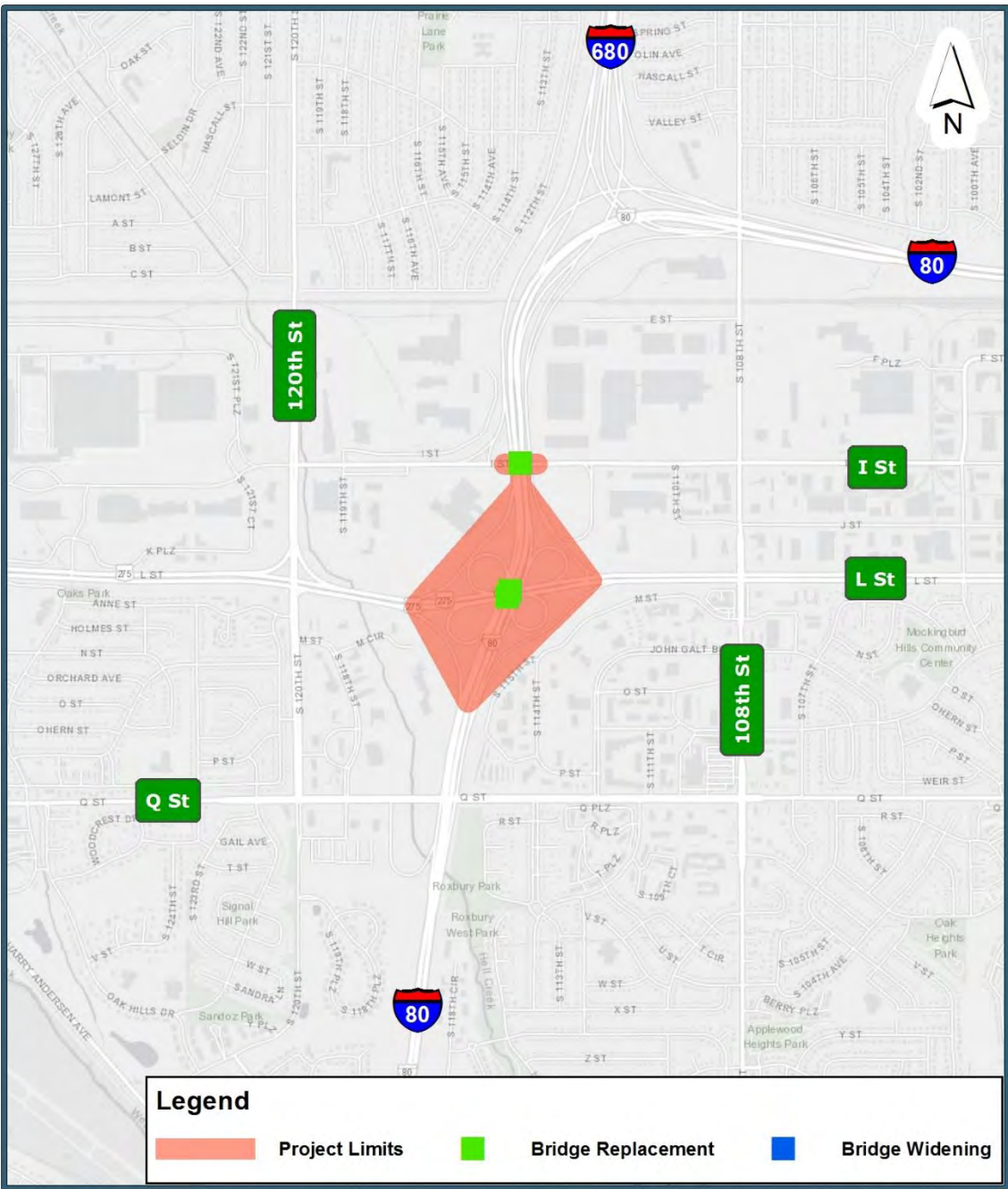

**Description**

This project primarily includes bridge replacements to set up the I-80 corridor to be expanded to four lanes in each direction, with 12-foot-wide shoulders. This project also includes reconfiguration of the full cloverleaf interchange at L Street to a DDI during the bridge replacements. Localized widening to an eight-lane facility on L Street between 120<sup>th</sup> Street (to the west) to 108<sup>th</sup> Street (to the east) is recommended to minimize the potential for arterial backups impacting L Street interchange operations and is included in the cost breakdown.

**Year of Need**

- The EB mainline operational need for four basic freeway lanes occurs in 2031.
- The expansion to four lanes on the WB I-80 mainline is not an operational need provided that E1 occurs in the interim.

**Year of Implementation**

- 2037–2038

**Implementation Considerations**

- E10 does NOT occur at the same time as any major system preservation activities.
- E10 would replace three bridges (S080 44507, S080 44508, and S080 44537) to provide enough lateral clearance for four lanes in each direction and 12-foot-wide shoulders.
- E1 expands WB I-80 to four basic lanes with sub-standard shoulder, so E10 provides enough lateral clearance for 12-foot-wide shoulders for WB I-80.

**Constructability**

- A majority of the interchange reconstruction activities will occur outside of the I-80 mainline and will not impact I-80 mainline traffic.
- Complex ramp terminal staging at L Street would be needed to maintain full access at the L Street interchange during reconstruction. Periods of closure for specific ramp movements are possible, with corresponding impacts on I-80 CD road operations. Lane closures, lane width reductions, and traffic shifts along L Street may be required during L Street interchange reconfiguration.
- Offsetting the new L Street bridges over I-80 with a permanent realignment of L Street through the reconfigured DDI interchange area could allow more of the interchange to be reconstructed with less impact to L Street and ramp operations.
- L Street and I Street bridge reconstruction may require lane closures and/or traffic shifts for the I-80 mainline and I-80 CD roads. Bridge reconstruction can be sequenced over 2 years to limit arterial street traffic impacts.

**Cost Breakdown (Current Year Dollars)**

The following table includes the costs (in \$ Millions) associated with the expansion:

Total	Pavement	Bridges	Walls / Barriers	Right-of-Way	Miscellaneous
\$32.49	\$22.44	\$8.66	\$0.79	-	\$0.60*

\* Miscellaneous costs include \$0.60M for signal costs at the L Street ramp terminals.





# E11

## I-80 WB Mainline Expansion: I Street to Q Street MP 445.54 – MP 444.35

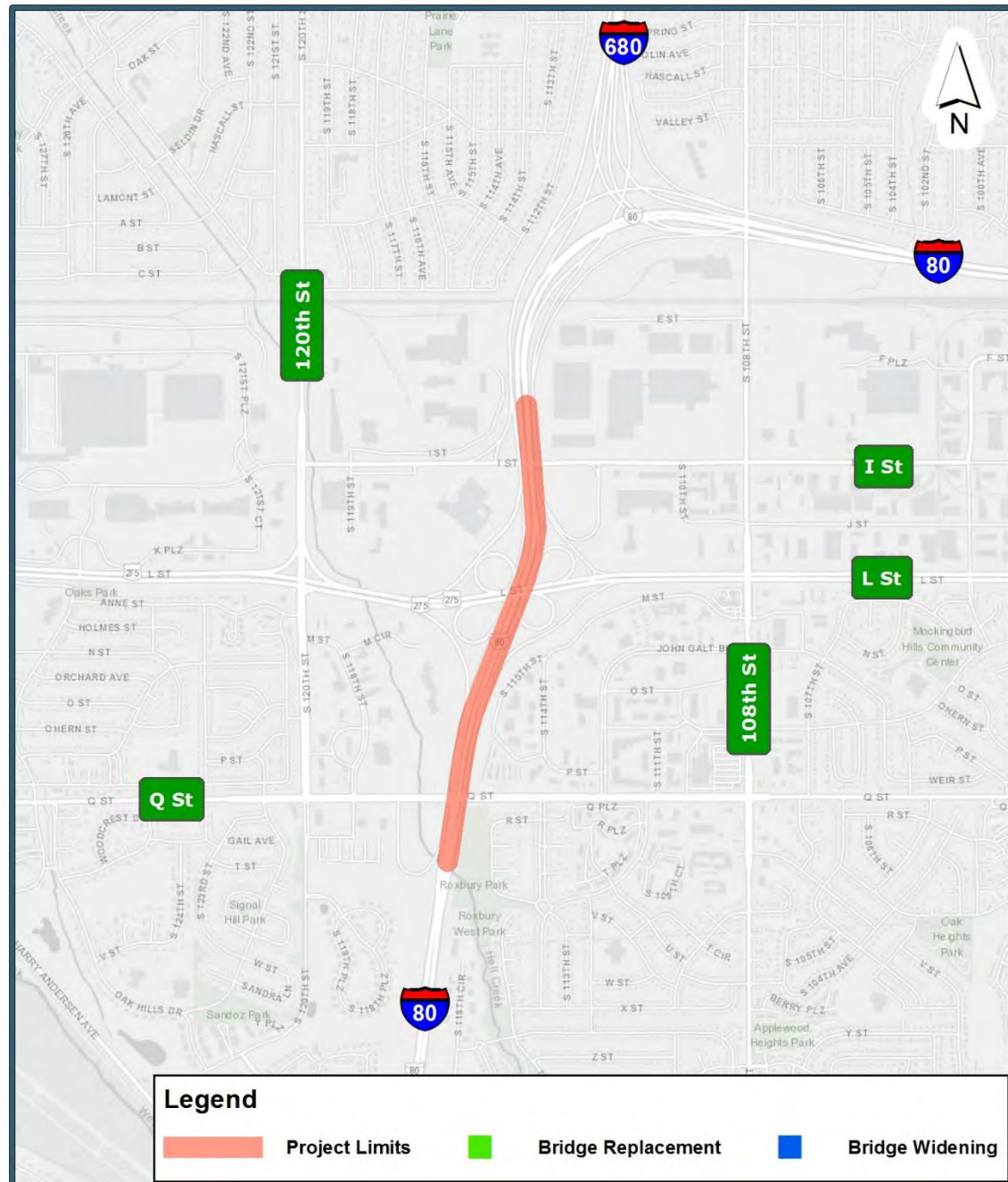

### Description

This project adds one basic lane (four lanes total) from I Street to the WB ILQ CD Road entrance ramp. This project connects with the expansion of the I-80 mainline between N-50 and the ILQ CD exit ramp to the west (E1 and E9, shown in blue and pink, respectively).

### Year of Need

- The mainline operational need for four basic freeway lanes for WB I-80 occurs in 2025.

### Year of Implementation

- 2042–2043

### Implementation Considerations

- E11 occurs at the same time as the full reconstruction of the WB I-80 CD road – S11.
- E11 occurs at the same time as the WB portion of E9.
- E10 needs to occur before E11 can be constructed.

### Constructability

- The WB I-80 mainline cross section can be expanded without full-time lane closures on the I-80 mainline. I-80 CD road lane closures may be necessary due to reconstruction of the WB CD road.

### Cost Breakdown (Current Year Dollars)

The following table includes the costs (in \$ Millions) associated with the expansion:

Total	Pavement	Bridges	Walls / Barriers	Right-of-Way	Miscellaneous
\$2.13	\$1.33	-	\$0.80	-	-

Total cost with full reconstruction of the WB I-80 CD road (S11): \$9.12M

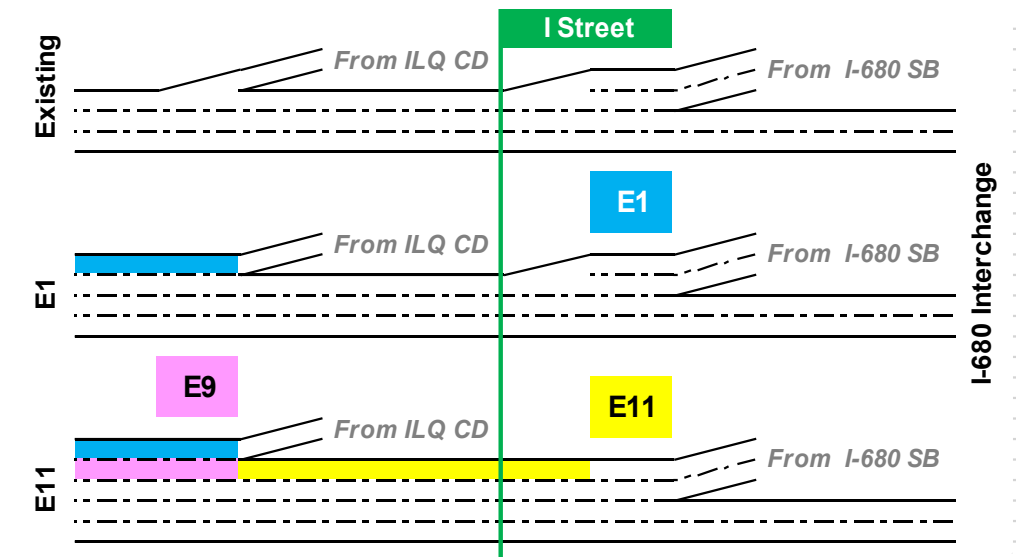

I-680 Interchange

# E12

## I-80 EB Mainline Expansion: Q Street to I-680 MP 444.45 – MP 445.56

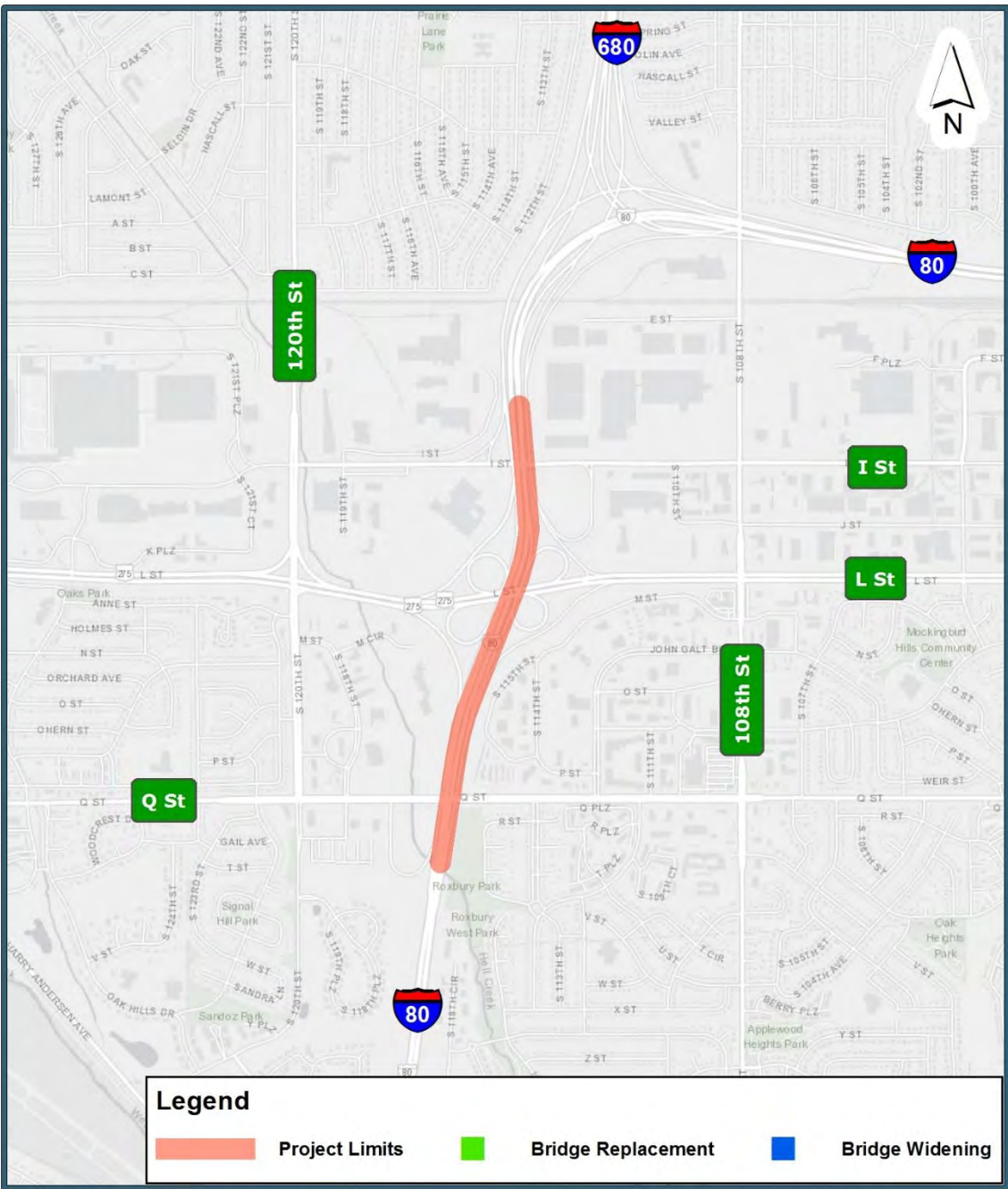

**Description**

This project adds one basic lane (four lanes total) from the NB ILQ exit ramp to the EB I-80 / NB I-680 split. This project connects with the expansion of the I-80 mainline between N-50 and the ILQ CD exit ramp to the west (E9, shown in blue).

**Year of Need**

- The mainline operational need for four basic freeway lanes for EB I-80 occurs in 2031.

**Year of Implementation**

- 2039–2040

**Implementation Considerations**

- E12 occurs at the same time as the second overlay of the EB I-80 CD road – S10.
- E12 occurs at the same time as the first overlay of the EB I-80 mainline – S5.
- E10 needs to occur before E12 can be constructed.

**Constructability**

- The EB I-80 mainline cross section can be expanded without full-time lane closures on the I-80 mainline. I-80 CD road lane closures may be necessary due to the concrete barrier relocation to the east.

**Cost Breakdown (Current Year Dollars)**

The following table includes the costs (in \$ Millions) associated with the expansion:

Total	Pavement	Bridges	Walls / Barriers	Right-of-Way	Miscellaneous
\$2.19	\$1.36	-	\$0.83	-	-

Total cost with an overlay of the EB I-80 CD road (S10): \$3.75M

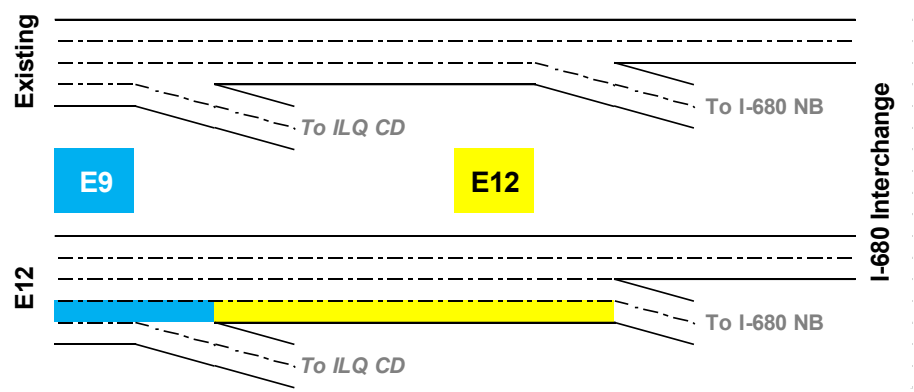



# E13

## I-80 WB Mainline Expansion: US-75 to 42<sup>nd</sup> Street MP 452.79 – MP 452.09

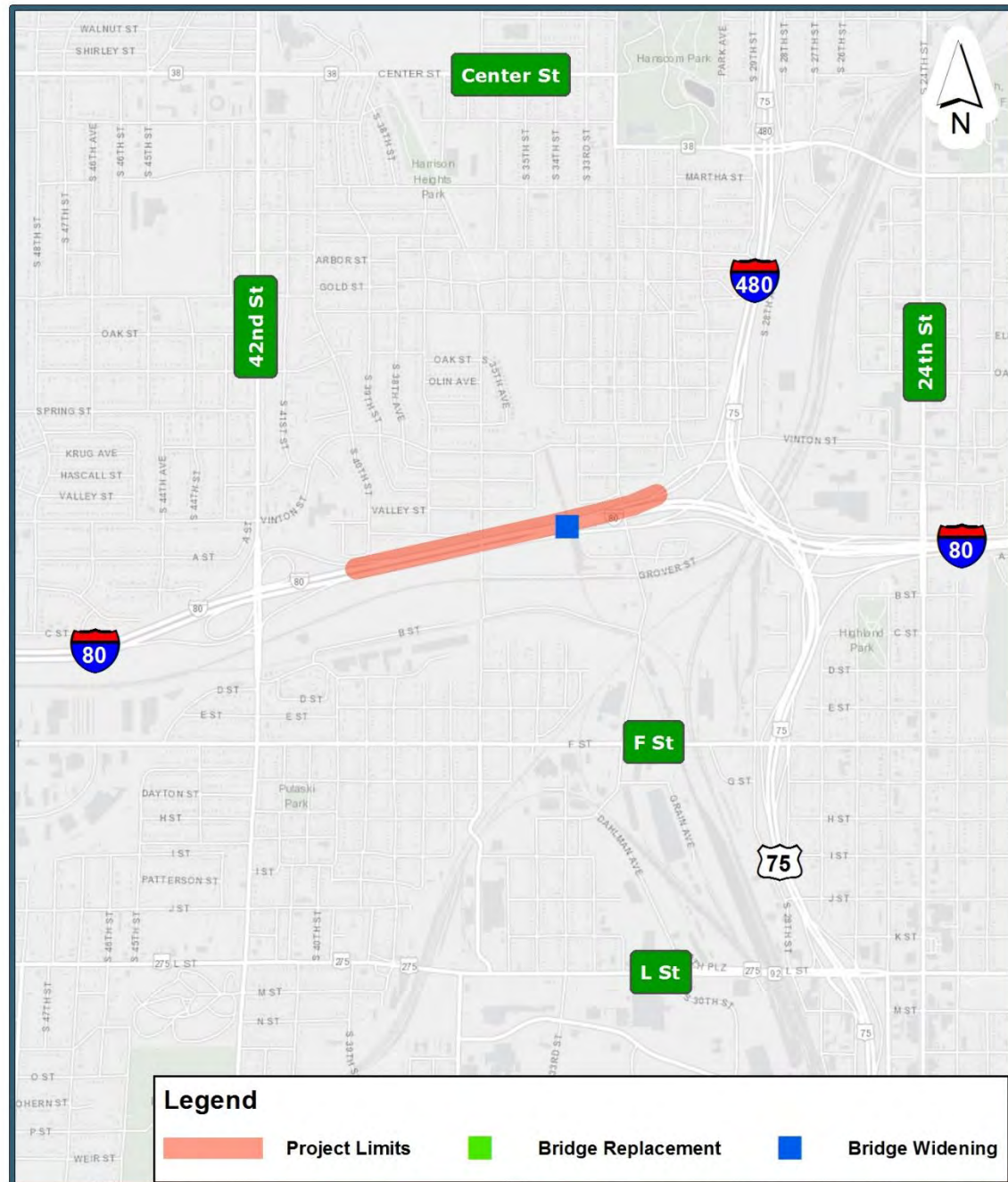

### Description

This project adds one WB lane on I-80 from the NB US-75 / SB I-480 to WB I-80 junction to the WB 42<sup>nd</sup> Street exit ramp. On WB I-80, two lanes from NB US-75 will combine with three lanes from SB I-480 to create five lanes total. The five-lane section will combine with three lanes from WB I-80 to create eight lanes total. The eight-lane section will split to six and two (six lanes to WB I-80 and two lanes to 42<sup>nd</sup> Street). No lane balance will be provided. This provides the two-lane flyover from NB US-75 to WB I-80 expansion (E24, shown in blue) enough receiving lanes so that a lane drop does not occur midway between US-75 and 42<sup>nd</sup> Street.

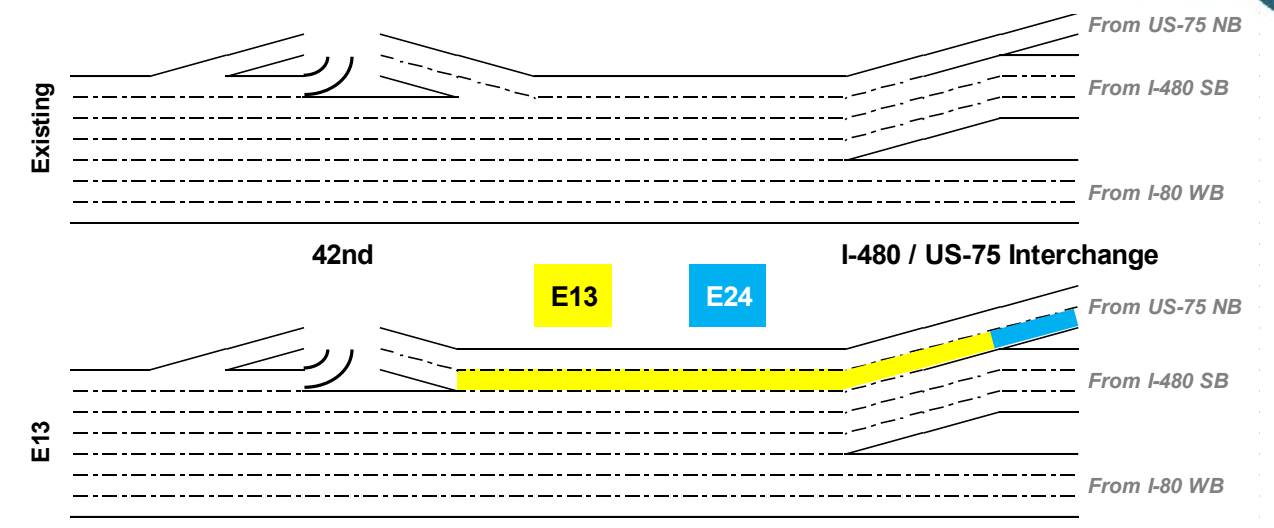

### Year of Need

- The mainline operational need is dependent on the timing of the two-lane flyover from NB US-75 to WB I-80, which is a need in 2019.

### Year of Implementation

- 2027–2029

### Implementation Considerations

- E13 occurs at the same time as the full reconstruction of I-80 from 50<sup>th</sup> Street to I-480 – S7.
- E13 would widen one bridge (S080 45252) to provide enough lateral clearance for one additional lane.

### Constructability

- The WB I-80 mainline cross section can be widened without full-time lane closures.
- Off-peak ramp closure may occur at the WB 42<sup>nd</sup> Street exit ramp.

### Cost Breakdown (Current Year Dollars)

The following table includes the costs (in \$ Millions) associated with the expansion:

Total	Pavement	Bridges	Walls / Barriers	Right-of-Way	Miscellaneous
\$10.83	\$3.05	\$0.85	\$0.93	\$6.00	-

Total cost with full reconstruction on I-80 between 50<sup>th</sup> Street and I-480 (S7): \$44.15M

**E14** I-480 Bridge Replacements: Woolworth Avenue, Leavenworth Street, and St. Mary's Avenue  
MP 001.13, 001.80, and 001.88

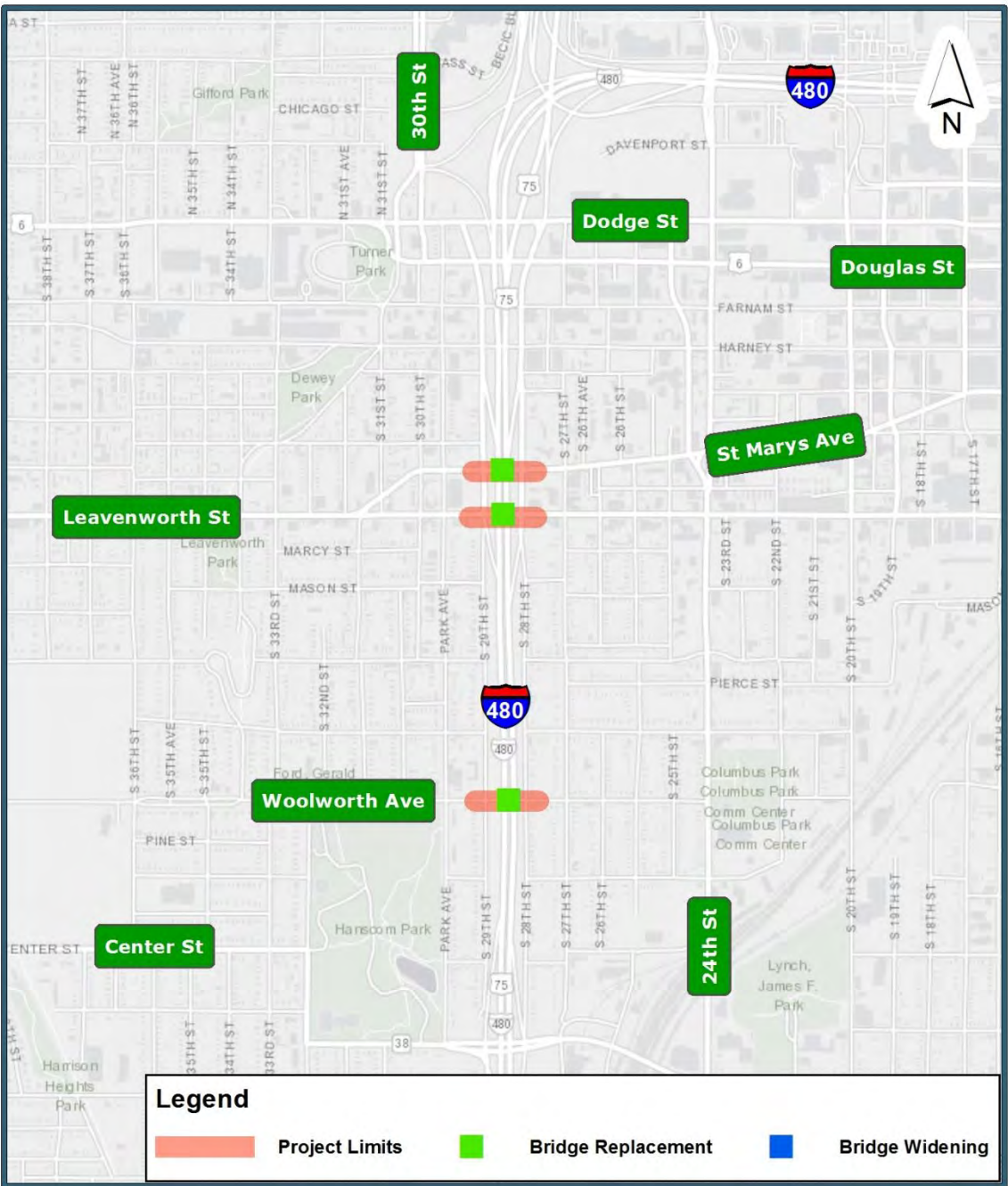

**Description**

This project includes bridge replacements at Woolworth Avenue, Leavenworth Street, and St. Mary's Avenue to set up the I-480 corridor to be expanded to the recommended number of lanes with 12-foot-wide shoulders. Due to the profiles of the bridges over I-480, it is anticipated that some reconstruction will occur at the intersections and arterials (that is, 28<sup>th</sup> Street and 29<sup>th</sup> Street) adjacent to the bridge replacements.

**Year of Need**

- The mainline operational need occurs in 2021.

**Year of Implementation**

- 2025–2027

**Implementation Considerations**

- E14 does NOT occur at the same time as any major system preservation activities.
- E14 would replace three bridges (S480 00131, S480 00180, and S480 00188) to provide enough lateral clearance for the recommended number of lanes for E15, with 12-foot-wide shoulders and additional clearance for one lane of expandability in both directions.

**Constructability**

- Bridge replacement may require traffic shifts and/or lane closures on the I-480 mainline.
- Bridge reconstruction will be spaced out 1 year at a time so that two out of three east-west arterials over I-480 are provided. Temporary conversion to two-way side street traffic may be required to maintain local access.

**Cost Breakdown (Current Year Dollars)**

The following table includes the costs (in \$ Millions) associated with the expansion:

Total	Pavement	Bridges	Walls / Barriers	Right-of-Way	Miscellaneous
\$13.70	\$4.10	\$9.23	\$0.37	-	-



# E15

## I-480 Mainline Expansion: I-80 to Harney Street MP 000.15 – MP 001.69

### Description

This project adds one lane to the following locations:

- NB I-480 – Martha Street to Leavenworth Street
- SB I-480 – North of Harney Street to the SB system ramp from SB I-480 to EB I-80

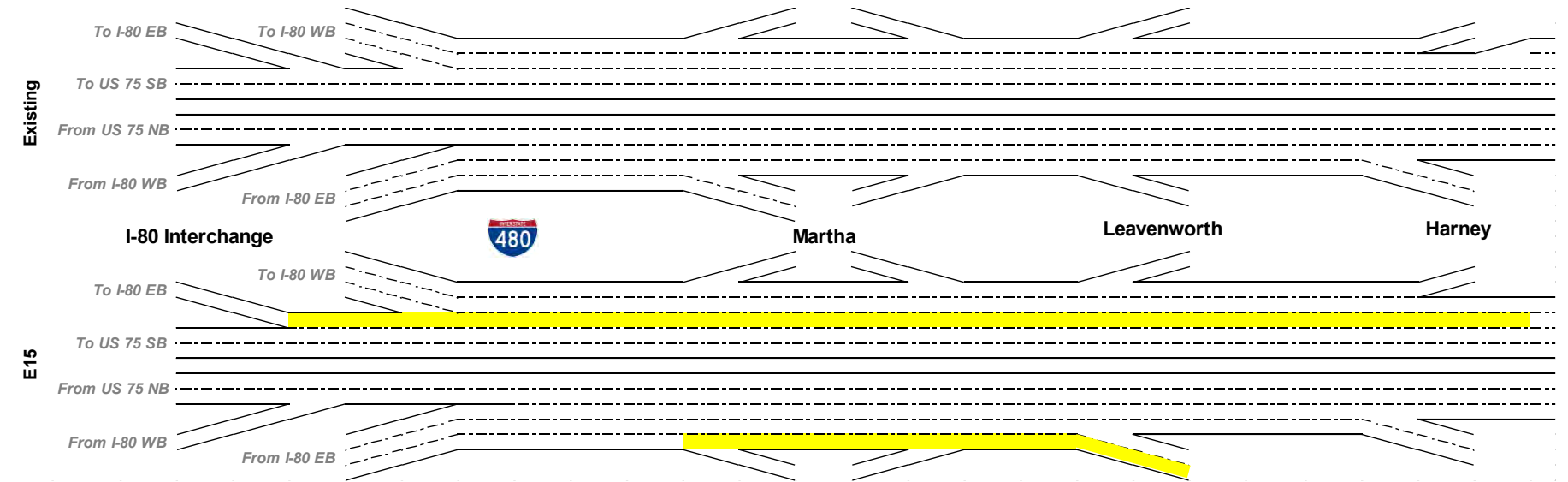

### Implementation Considerations

- E15 occurs at the same time as the full reconstruction of I-480 from Harney Street to I-80 – S12.
- E15 would widen four bridges (S480 00019L, S480 00062L, S480 00088L, and S480 00088R) to provide enough lateral clearance for the additional lanes and 12-foot-wide shoulders.
- Diversion of two-way traffic to the east and west sides of I-480 will be necessary for complete pavement reconstruction and to keep north-south traffic flow at all times.

### Constructability

- I-480 mainline reconstruction on alignment may require long-term single lane reductions on I-480 because of tight existing right-of-way and the need to construct variable height retaining walls along the widening.
- Ramp closures may occur at Martha Street ramps, Leavenworth Street ramps, and Harney Street ramps. Ramp closure durations should be limited to much less than a construction season. Ramp closures should be sequenced to avoid concurrent closures at adjacent interchanges.

### Cost Breakdown (Current Year Dollars)

The following table includes the costs (in \$ Millions) associated with the expansion:

Total	Pavement	Bridges	Walls / Barriers	Right-of-Way	Miscellaneous
\$13.83	\$6.73	\$1.29	\$5.81	-	-

Total cost with full reconstruction on I-480 between I-80 and Harney Street (S12): \$38.05M

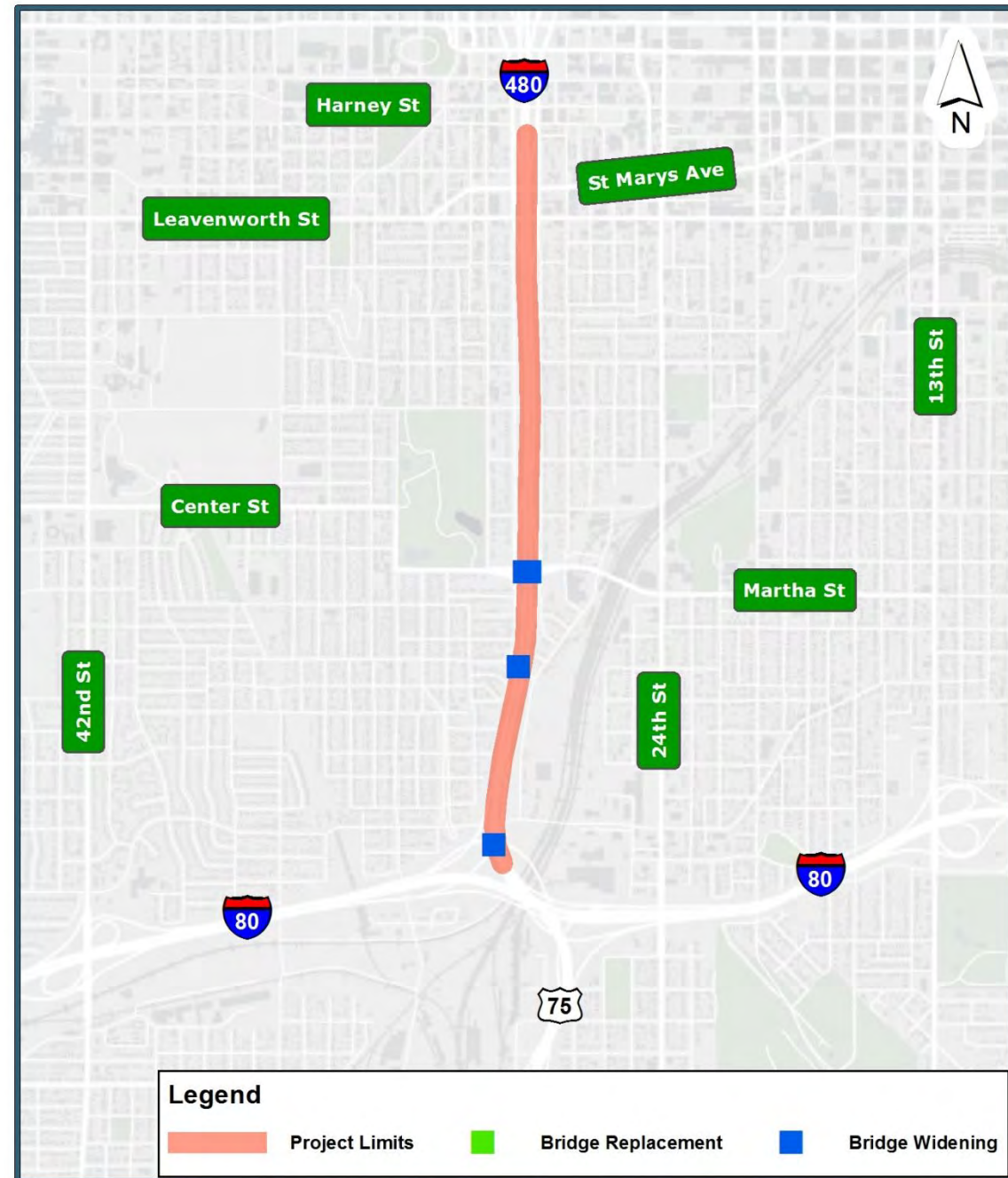

Year of Need	Year of Implementation
The mainline operational need occurs in 2021.	2028–2030

**E16** I-680 Mainline Expansion:  
Pacific Street to West Dodge Road  
MP 001.55 – MP 002.71

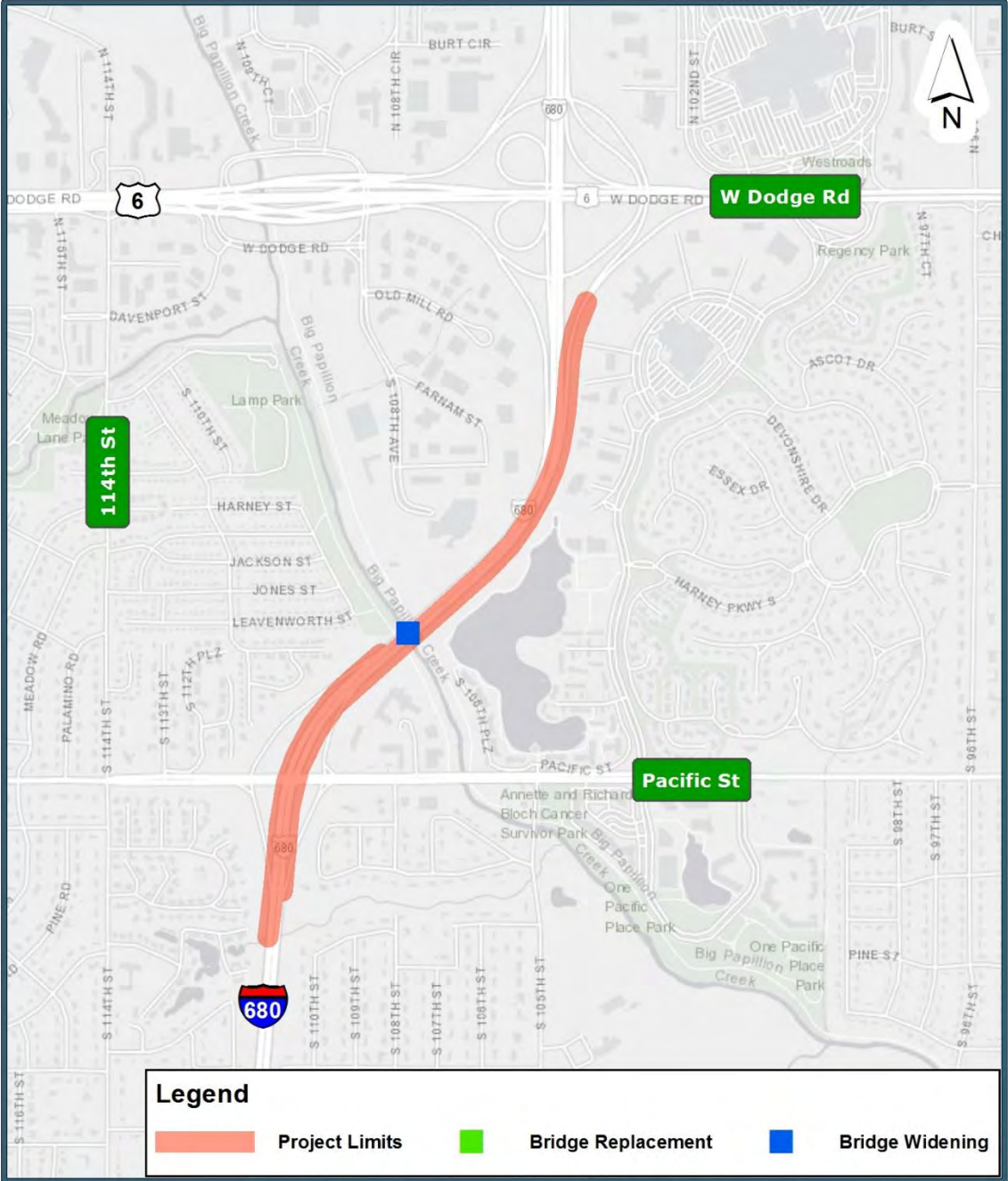

**Description**

This project adds one lane to the following locations:

- NB I-680 – Under Pacific Street to the NB system ramp from NB I-680 to EB West Dodge Road
- SB I-680 – Under Pacific Street

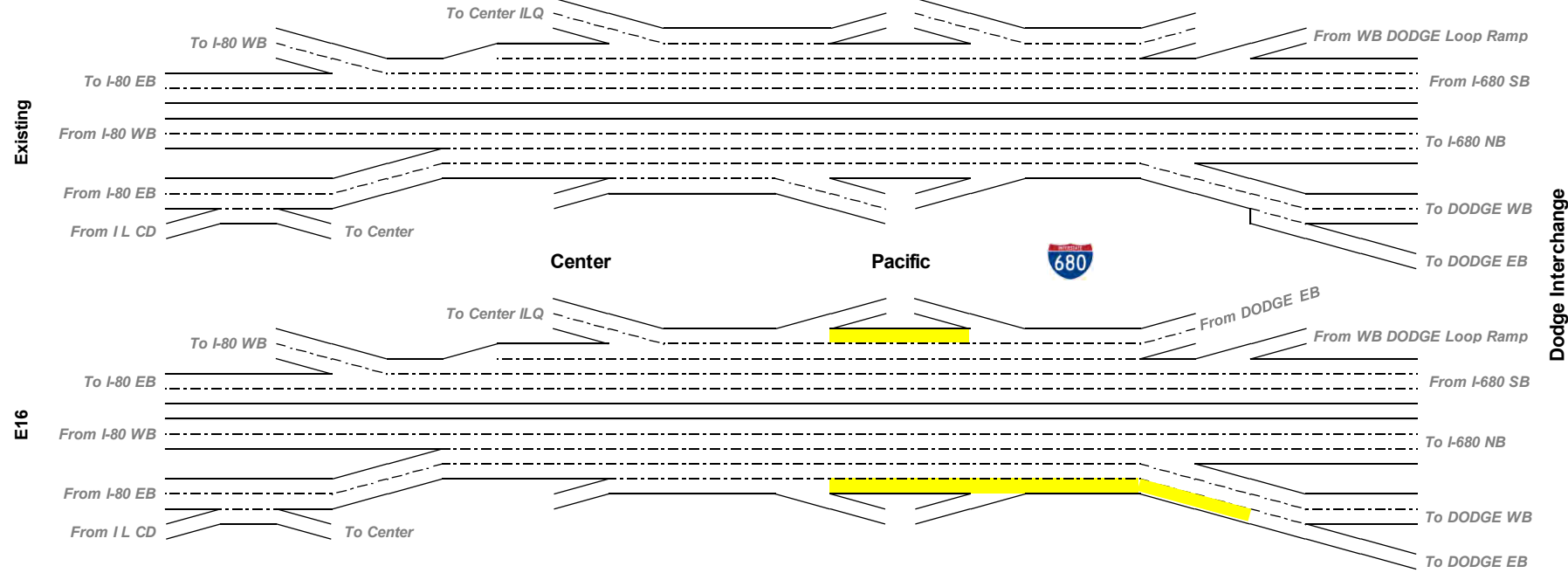

**Year of Need**

- The mainline operational need occurs in 2019.

**Year of Implementation**

- 2026–2027

**Implementation Considerations**

- E16 does NOT occur at the same time as any major system preservation activities.
- E16 would widen one bridge (S680 00216) to provide enough lateral clearance for the additional lanes and 12-foot-wide shoulders.

**Constructability**

- The I-680 mainline cross section can be widened without full-time lane closures.
- Off-peak ramp closures may occur at Pacific Street and the NB I-680 to West Dodge Road system ramp.

**Cost Breakdown (Current Year Dollars)**

The following table includes the costs (in \$ Millions) associated with the expansion:

Total	Pavement	Bridges	Walls / Barriers	Right-of-Way	Miscellaneous
\$4.80	\$4.12	\$0.68	-	-	-



# E17

## I-680 Mainline Expansion: Fort Street to Blair High Road MP 005.78 – MP 007.41

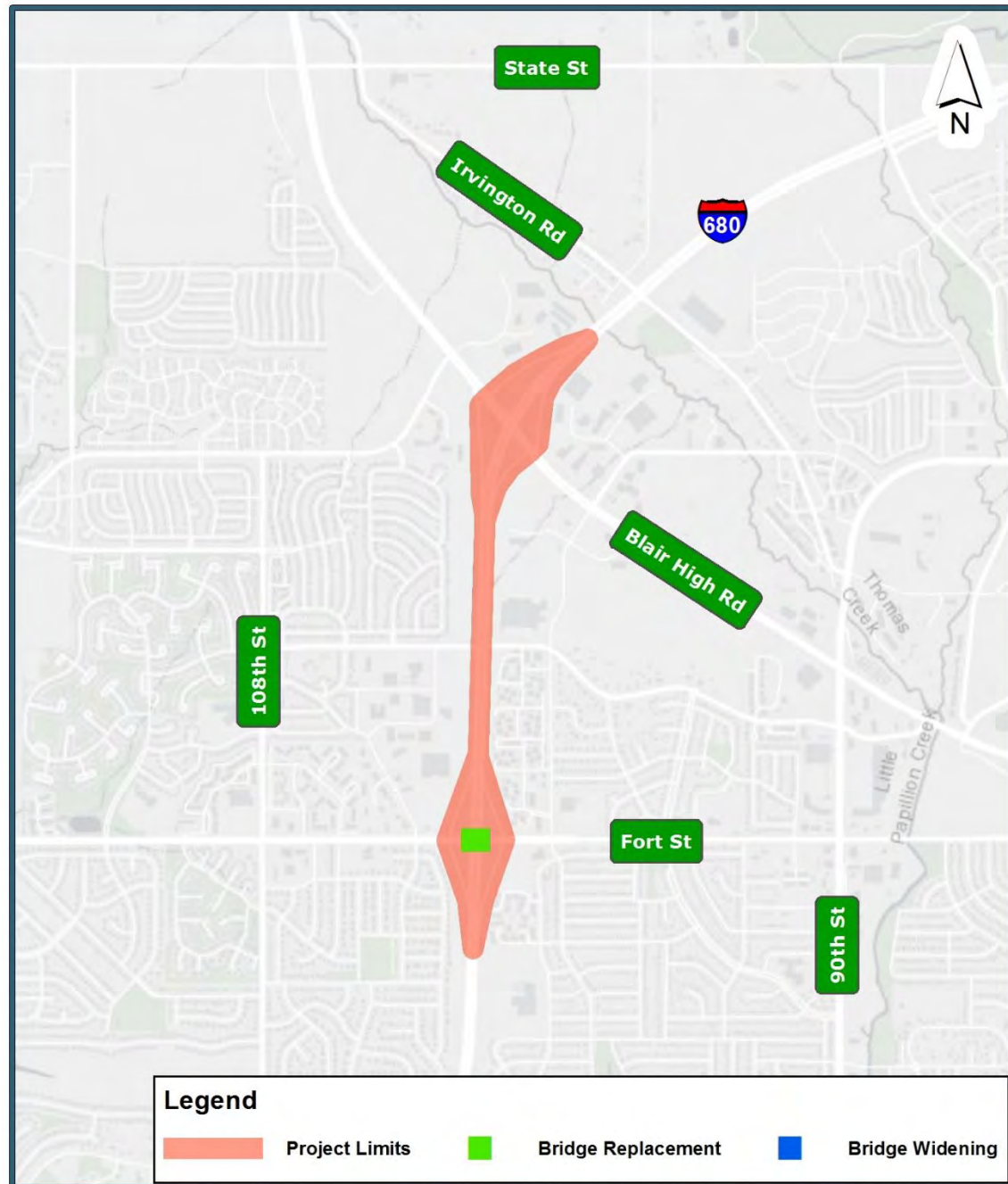

### Description

This project is included in the BNA and expands the existing configuration of the I-680 mainline to the recommended IJR concept. This includes the addition of one basic freeway lane with auxiliary lanes between Fort Street and Blair High Road. This project also includes interchange reconfigurations to parclo interchanges at Fort Street and Blair High Road. The EB Fort Street to NB I-680 ramp will not be constructed as part of E17, but the NB I-680 exit ramp at Fort Street will be shifted to the east to allow for the loop ramp to be constructed later.

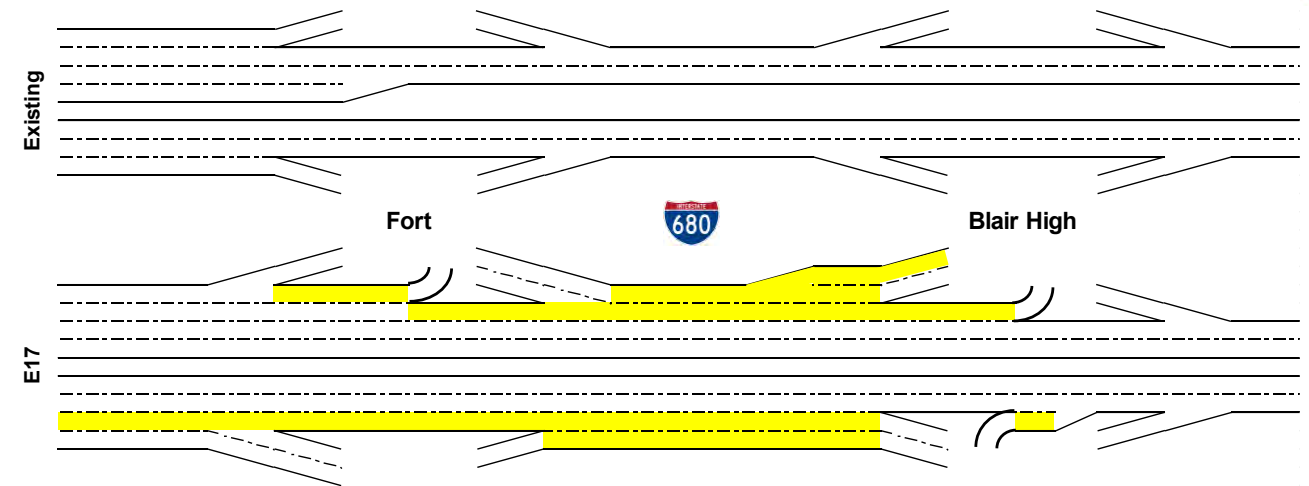

### Implementation Considerations

- E17 occurs at the same time as the full reconstruction of I-680 from Irvington Street to Fort Street – S18.
- E17 would replace two bridges (S680 00604L and S680 00604R) to provide enough lateral clearance for the recommended number of lanes for E17 and 12-foot-wide shoulders.

### Constructability

- I-680 mainline reconstruction on alignment may require temporary pavement and/or lane reductions on I-680.
- Interchange ramp additions and modifications at Fort Street and Blair High Road may require ramp closures and/or temporary surfacing to maintain access.
- At Fort Street, the new ramps may be constructed prior to the loop ramps to minimize impacts to traffic flow on the existing ramp alignments.
- At Blair High Road, the new NB ramps may be constructed prior to the EB Blair High Road to NB I-680 loop ramp to minimize impacts to traffic flow on the existing ramp alignments.
- A portion of the Fort Street bridge reconstruction will be constructed off alignment in order to shift I-680 mainline lanes to reconstruct the existing Fort Street bridges.

### Cost Breakdown (Current Year Dollars)

The following table includes the costs (in \$ Millions) associated with the expansion:

Total	Pavement	Bridges	Walls / Barriers	Right-of-Way	Miscellaneous
\$29.00*	Cost Determined by NDOT				

\* Not included in the Constrained Implementation Plan since this project is funded by the BNA. The total includes expansion and full reconstruction of I-680 between Fort Street and Blair High Road.

Year of Need	Year of Implementation
The mainline operational need occurs in 2019.	2023–2025

E18

I-680 Mainline Expansion:  
I-80 to Pacific Street  
MP 000.33 – MP 001.55

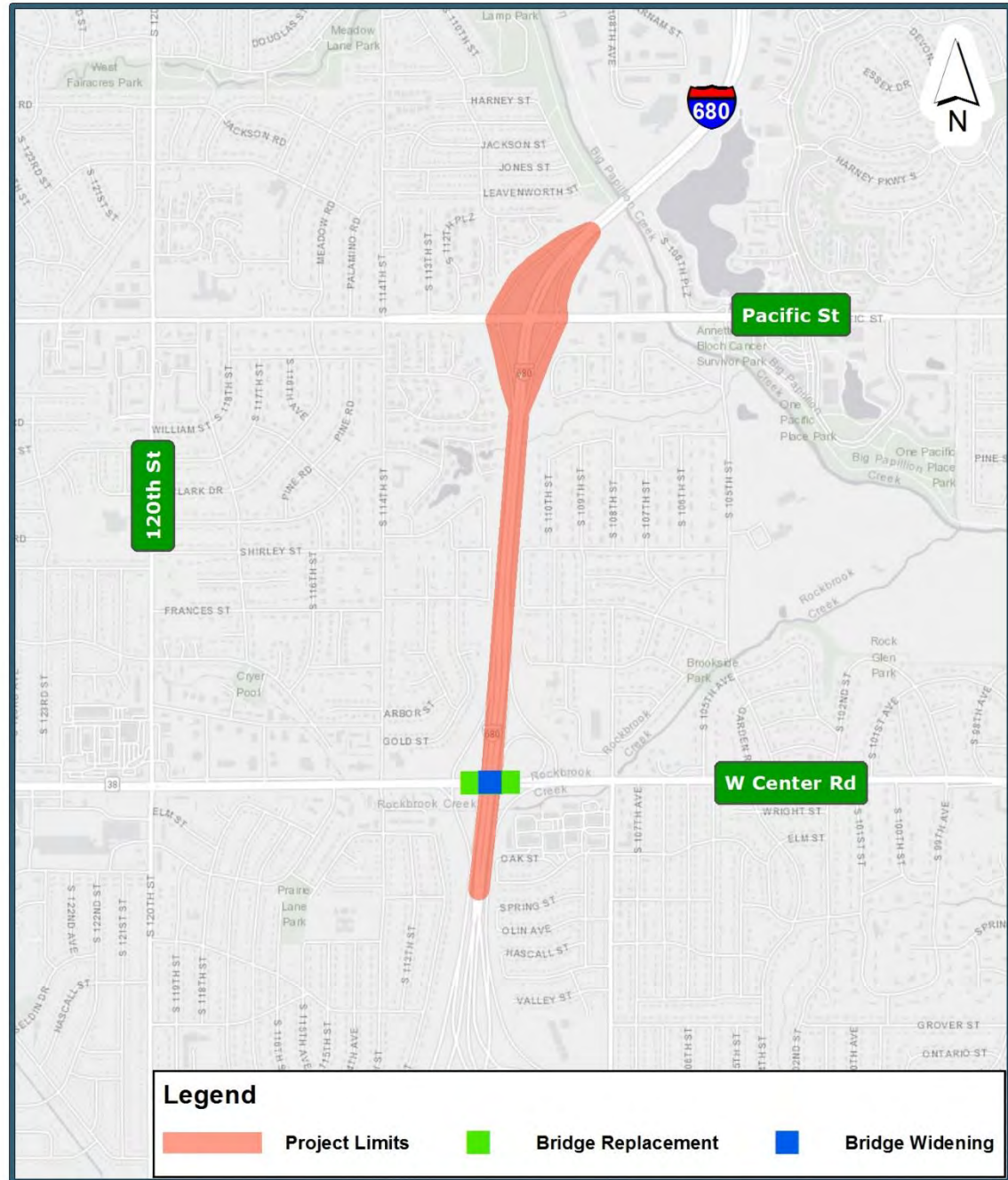

Description

This project (shown in yellow) connects with two projects (E7, shown in pink, and E16, shown in blue), and adds one or two lanes to the following locations:

- NB I-680 – System interchange ramp from EB I-80 to the NB Pacific Street exit ramp, and the system interchange ramp from WB I-80 to the NB West Center Road entrance ramp
- SB I-680 – Pacific Street to the system interchange ramp to WB I-80 and the system interchange ramp from SB I-680 to EB I-80.

This project also includes interchange reconfiguration to a DDI at the Pacific Street interchange.

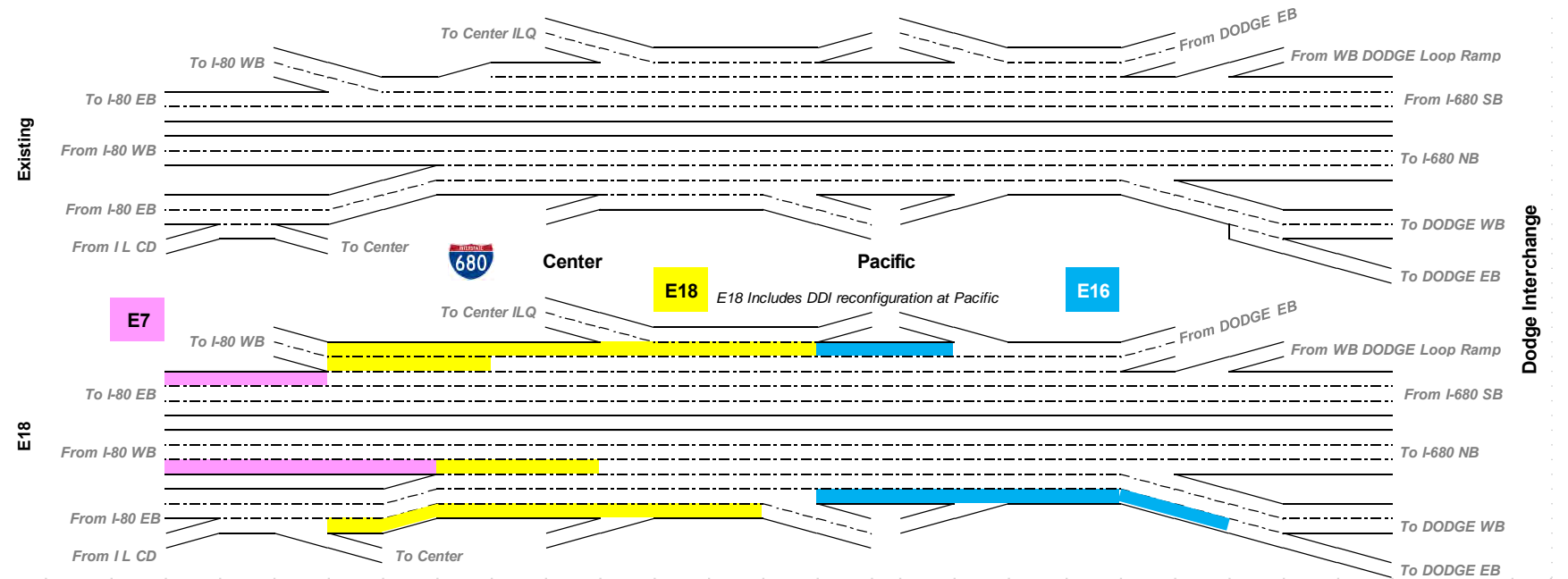

Implementation Considerations

- E18 does NOT occur at the same time as any major system preservation activities.
- E18 would replace two bridges (S680 00083A and S680 00083B) to provide enough lateral clearance to widen the I-680 mainline bridge over West Center Road (S680 00083) for the recommended number of lanes for E18 and 12-foot-wide shoulders.

Constructability

- The I-680 mainline cross section can be widened without full-time lane closures.
- Complex ramp terminal staging at Pacific Street would be necessary to maintain full access at the Pacific Street interchange during the reconfiguration to a DDI. Periods of closure for specific ramp movements are possible.
- A long-term closure of the NB West Center Road loop ramp (NB to WB) will be required to replace bridge S680 00083A. A temporary diamond-type ramp connection will replace this movement during construction.
- The SB CD road bridge over West Center Road will be shifted to the west (along with the SB CD road near West Center Road) to minimize closure times. The new SB West Center Road ramps will also be constructed off alignment to minimize closure times.

Cost Breakdown (Current Year Dollars)

The following table includes the costs (in \$ Millions) associated with the expansion:

Total	Pavement	Bridges	Walls / Barriers	Right-of-Way	Miscellaneous
\$20.69*	\$15.84	\$4.16	-	\$0.09	\$0.60**

\* The total of \$20.69M accounts for all mainline widening costs and the portion of the interchange expansion assumed to be covered by NDOT.

\*\* Miscellaneous costs include \$0.60M for signal costs at the Pacific Street ramp terminals.

Year of Need	Year of Implementation
The mainline operational need for five lanes SB over West Center Road occurs in 2037. Localized weaving needs between Pacific Street and West Center Road occur in 2019.	2032–2034





# E19

## I-680 Mainline Expansion: West Dodge Road to West Maple Road MP 003.15 – MP 004.44

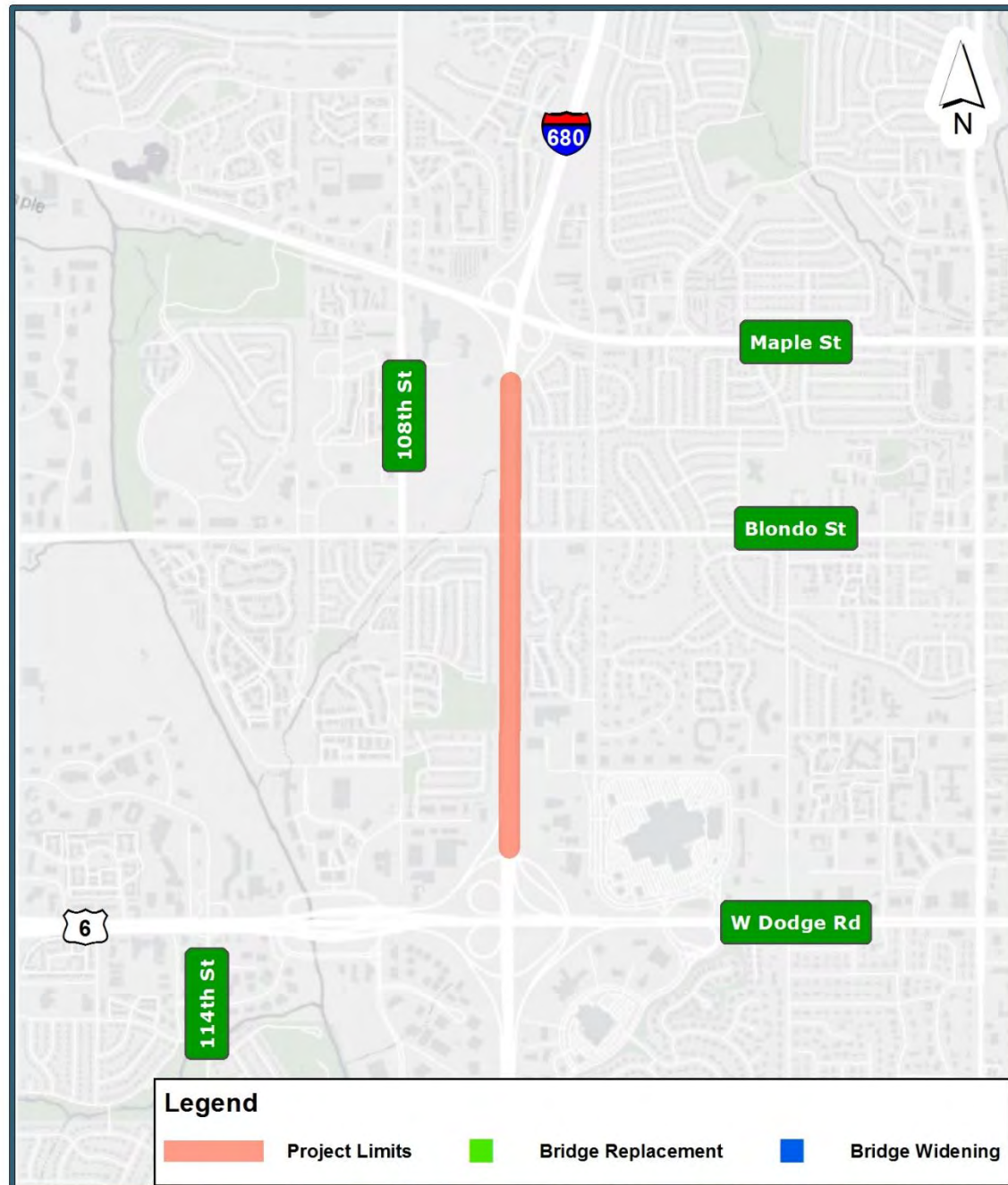

### Description

This project adds one SB lane on I-680 from the EB West Maple Road to SB I-680 entrance ramp to the I-680 system interchange ramp to West Dodge Road, and one NB lane from the system interchange ramps from West Dodge Road to West Maple Road. This project also includes splitting one entrance ramp to two entrance ramps (WB and EB Dodge to NB I-680) to increase the weaving distance between West Dodge Road and West Maple Road.

### Year of Need

- The mainline operational need occurs in 2019.

### Year of Implementation

- 2030–2031

### Implementation Considerations

- E18 does NOT occur at the same time as any major system preservation activities.
- E18 does not have any bridge work associated with the I-680 mainline widening.

### Constructability

- The I-680 mainline cross section can be widened without full-time lane closures.
- Off-peak ramp closures may occur at the West Maple Road and West Dodge Road system ramps to and from I-680 (to the north).

### Cost Breakdown (Current Year Dollars)

The following table includes the costs (in \$ Millions) associated with the expansion:

Total	Pavement	Bridges	Walls / Barriers	Right-of-Way	Miscellaneous
\$3.73	\$3.73	-	-	-	-

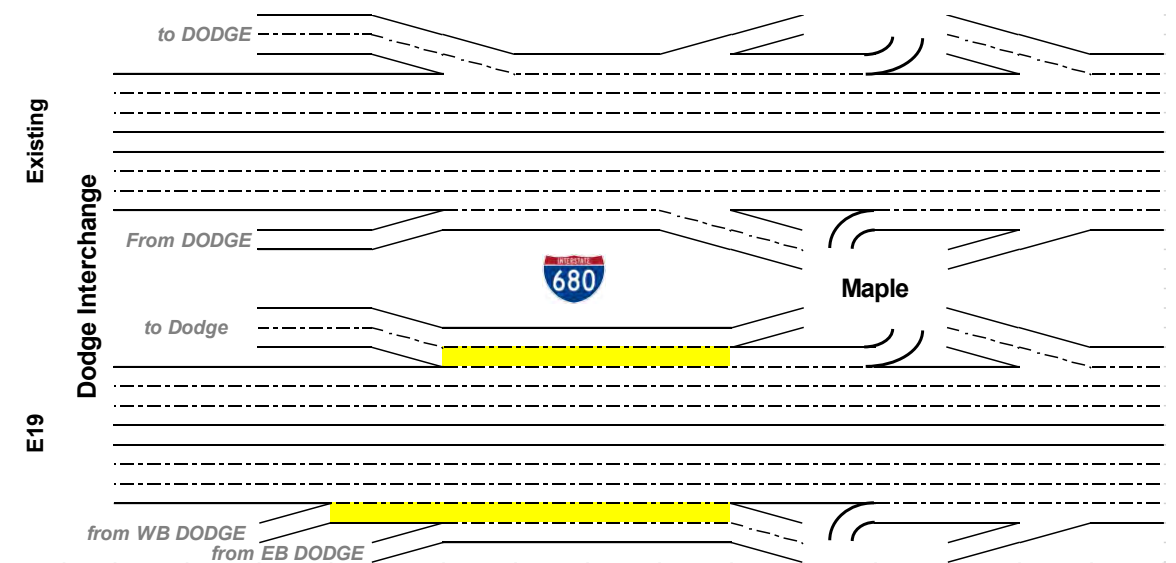

**E20** US-75 NB Mainline Expansion: Chandler Road to F Street  
MP 085.33 – MP 087.51

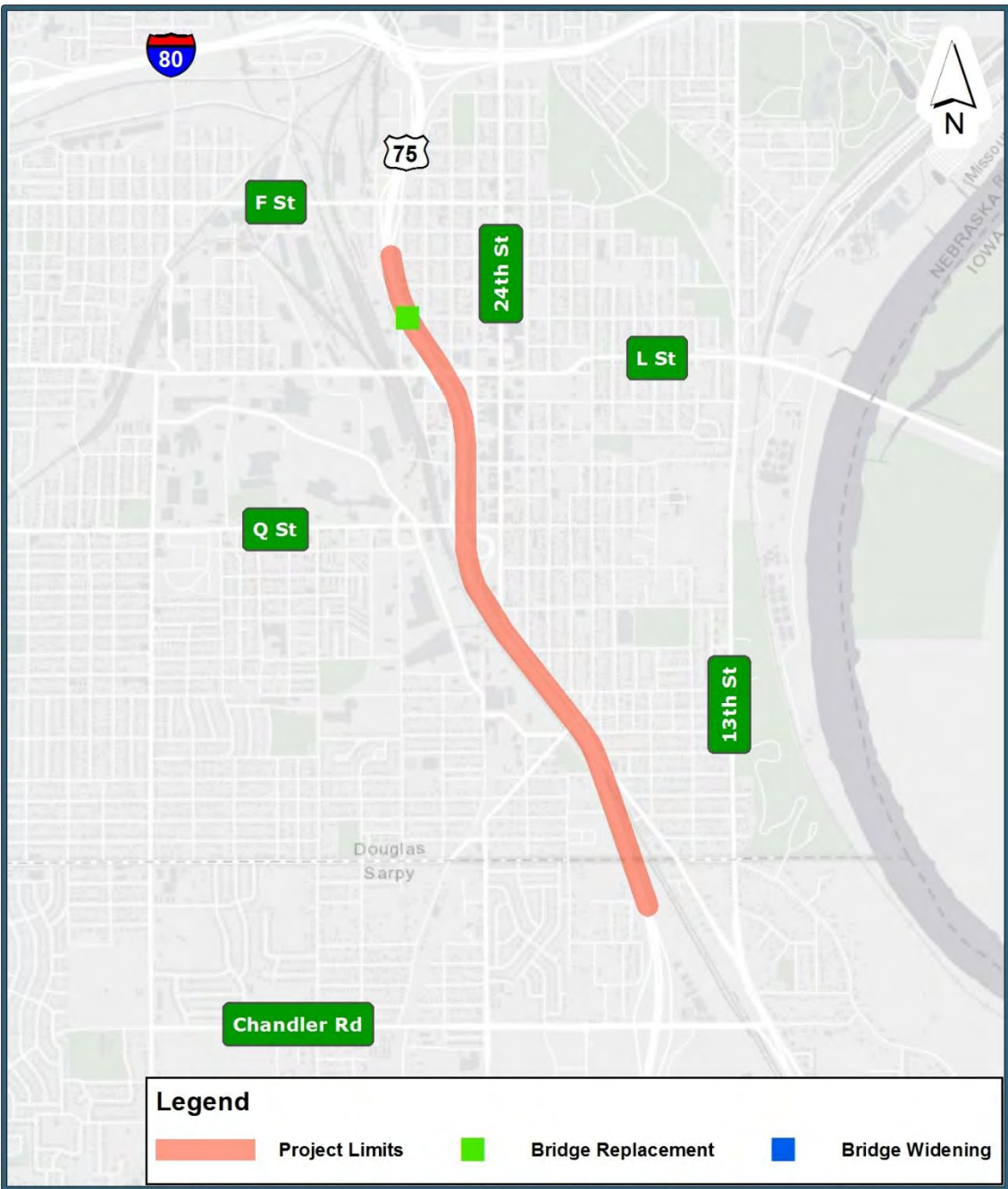

**Description**

This project is included in the BNA and adds one NB lane on US-75 from Chandler Road to F Street.

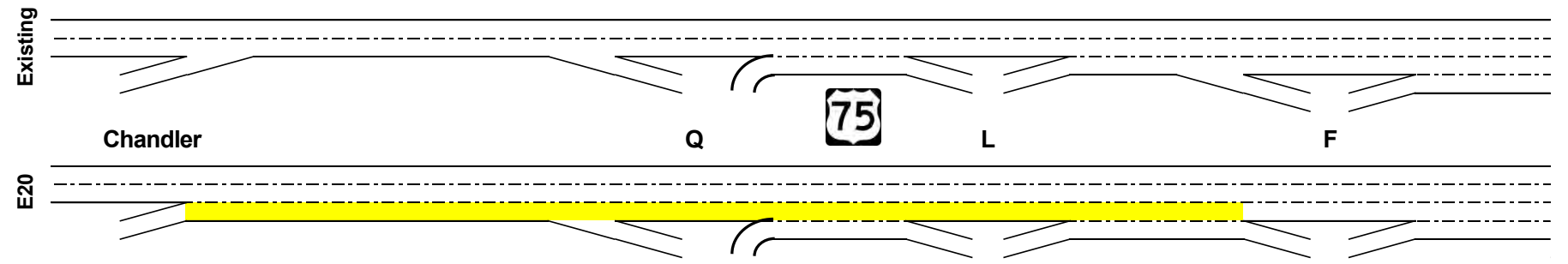

**Year of Need**

- The mainline operational need occurs in 2019.

**Year of Implementation**

- 2022–2023

**Implementation Considerations**

- E20 occurs at the same time as the second overlay – S28.
- E20 would replace one bridge (S075 08730R) due to the age and condition of the structure, and because the existing structure does not provide enough lateral clearance for the one-lane expansion. The new structure should provide enough lateral clearance for the recommended number of lanes for the full expansion of US-75 in E24.
- E20 does NOT impact the UPRR bridge (S075 08580R) by allowing a shoulder exception on the UPRR bridge (similar to the existing SB configuration).
- E20 should be designed to set the corridor up for full reconstruction and expansion in E24.

**Constructability**

- The NB US-75 mainline cross section can be widened without full-time lane closures except in the vicinity of the NB bridge replacement between L Street and F Street (S075 08730R).
- Off-peak ramp closures may occur at the Q Street, L Street, and F Street ramps.

**Cost Breakdown (Current Year Dollars)**

The following table includes the costs (in \$ Millions) associated with the expansion:

Total	Pavement	Bridges	Walls / Barriers	Right-of-Way	Miscellaneous
\$9.00*	Cost Determined by NDOT				

\* Not included in the Constrained Implementation Plan since this project is funded by the BNA. The total includes the expansion and an overlay of US-75 between I-80 and Q Street (S28).



# E21

## US-75 Mainline Expansion: N-370 to Chandler Road MP 081.92 – MP 085.33

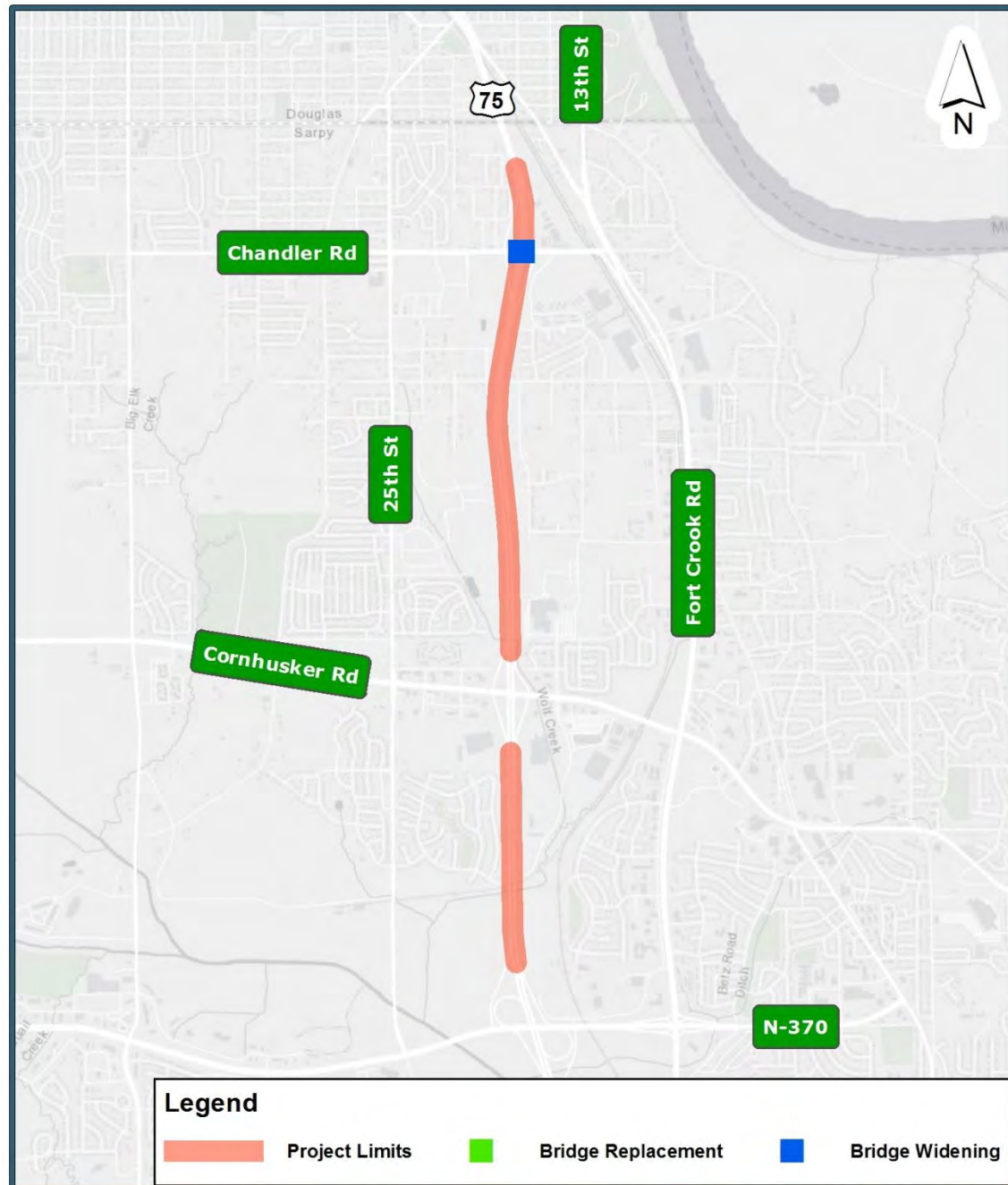

### Description

This project (shown in yellow) adds one basic lane on US-75 from Chandler Road to Cornhusker Road. An auxiliary lane is added between Cornhusker Road and N-370. This section of US-75 would be widened to the inside to modify the existing 64-foot-wide median section to a 40-foot-wide section with a median high-tension cable barrier. This project connects with two expansion projects to the north: E20 (shown in green) and E25 (shown in blue).

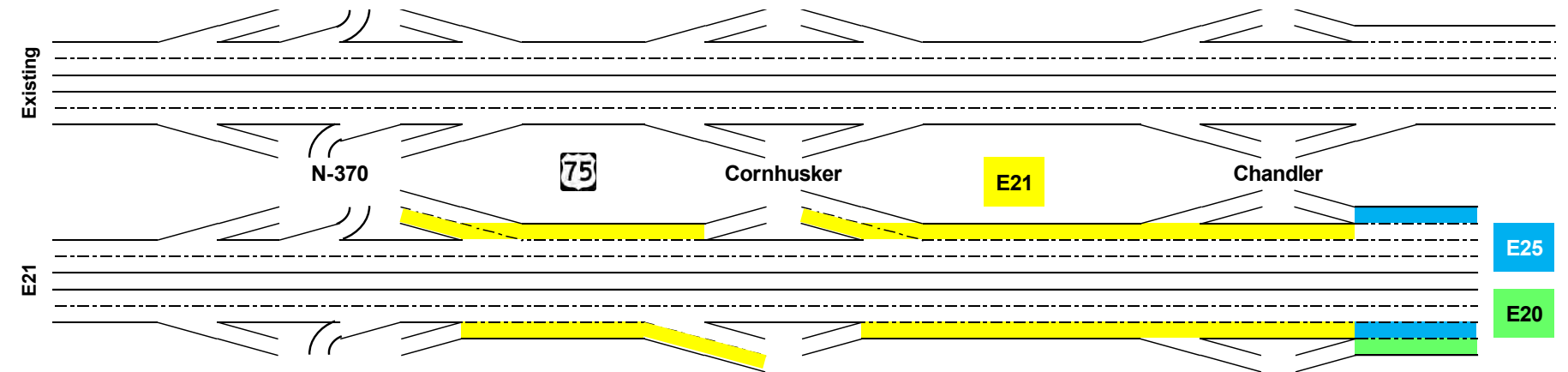

### Year of Need

- The mainline operational need between Chandler Road and Cornhusker Road occurs in 2021.
- The mainline operational need between Cornhusker Road and N-370 occurs in 2029.

### Year of Implementation

- 2030–2032

### Implementation Considerations

- E21 occurs at the same time as the first overlay – S26.
- E21 would widen two bridges (S075 08495L and S075 08495R) to provide enough lateral clearance for the recommended number of lanes. Bridges should be widened to the inside to match the proposed 40-foot-wide median section.
- E21 does NOT impact the bridges over Hogantown Drive / 15<sup>th</sup> Street (S075 08248L and S075 08248R) by allowing a shoulder exception on the bridges for the interim condition.

### Constructability

- The US-75 mainline cross section can be widened without full-time lane closures.
- Off-peak ramp closures may occur at the Chandler Road, Cornhusker Road, and N-370 ramps.

### Cost Breakdown (Current Year Dollars)

The following table includes the costs (in \$ Millions) associated with the expansion:

Total	Pavement	Bridges	Walls / Barriers	Right-of-Way	Miscellaneous
\$12.65	\$11.95	\$0.70	-	-	-

Total cost with an overlay on US-75 I-480 between Chandler Road and Fairview Road (S26): \$28.34M

E22

Dahlman Avenue Expansion:  
F Street to L Street with  
Dahlman Avenue Rail Bridge Replacement

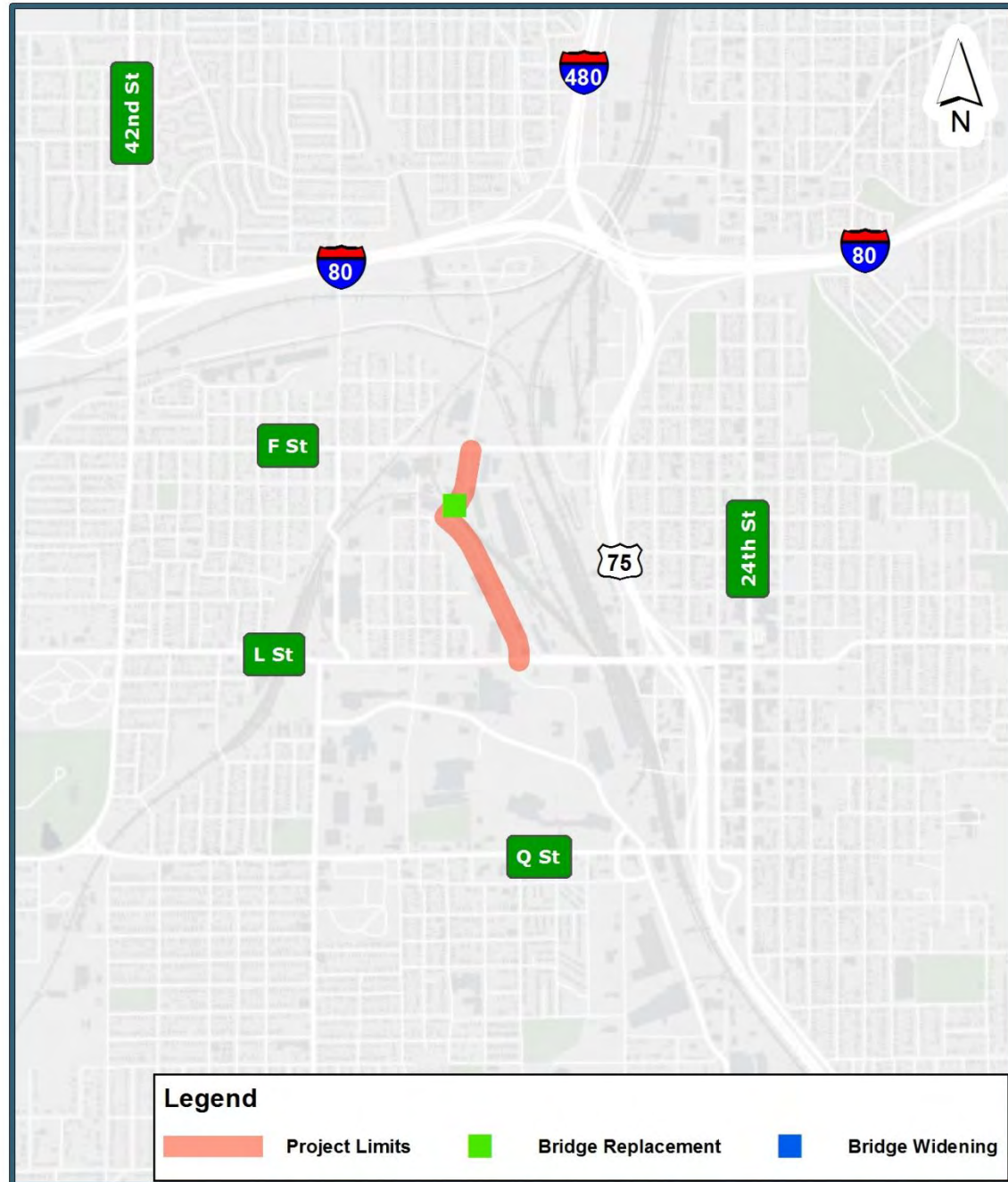

**Description**

This project improves the Dahlman Avenue corridor to provide truck access to US-75 via the L Street interchange once the F Street interchange is closed. This includes replacing the rail bridge (U1825D5305) near H Street to improve vertical and horizontal clearances at the rail bridge.

**Year of Need**

- The mainline operational need on US-75 occurs in 2029 provided that E20 occurs in the interim.

**Year of Implementation**

- 2030–2031

**Implementation Considerations**

- E22 would replace one rail bridge (U1825D5305) to fix the low clearance concerns.
- Early coordination with BNSF Railway Company would need to occur for replacement of the rail bridge.

**Constructability**

- The bridge replacement and roadway improvements would need to be open prior to the full closure of the F Street interchange.

**Cost Breakdown (Current Year Dollars)**

The following table includes the costs (in \$ Millions) associated with the expansion:

Total	Pavement	Bridges	Walls / Barriers	Right-of-Way	Miscellaneous
\$9.00	Cost Determined by NDOT				



# E23

## US-75 Bridge Replacements: Q Street, L Street, and F Street MP 086.63, 087.11, and 087.66

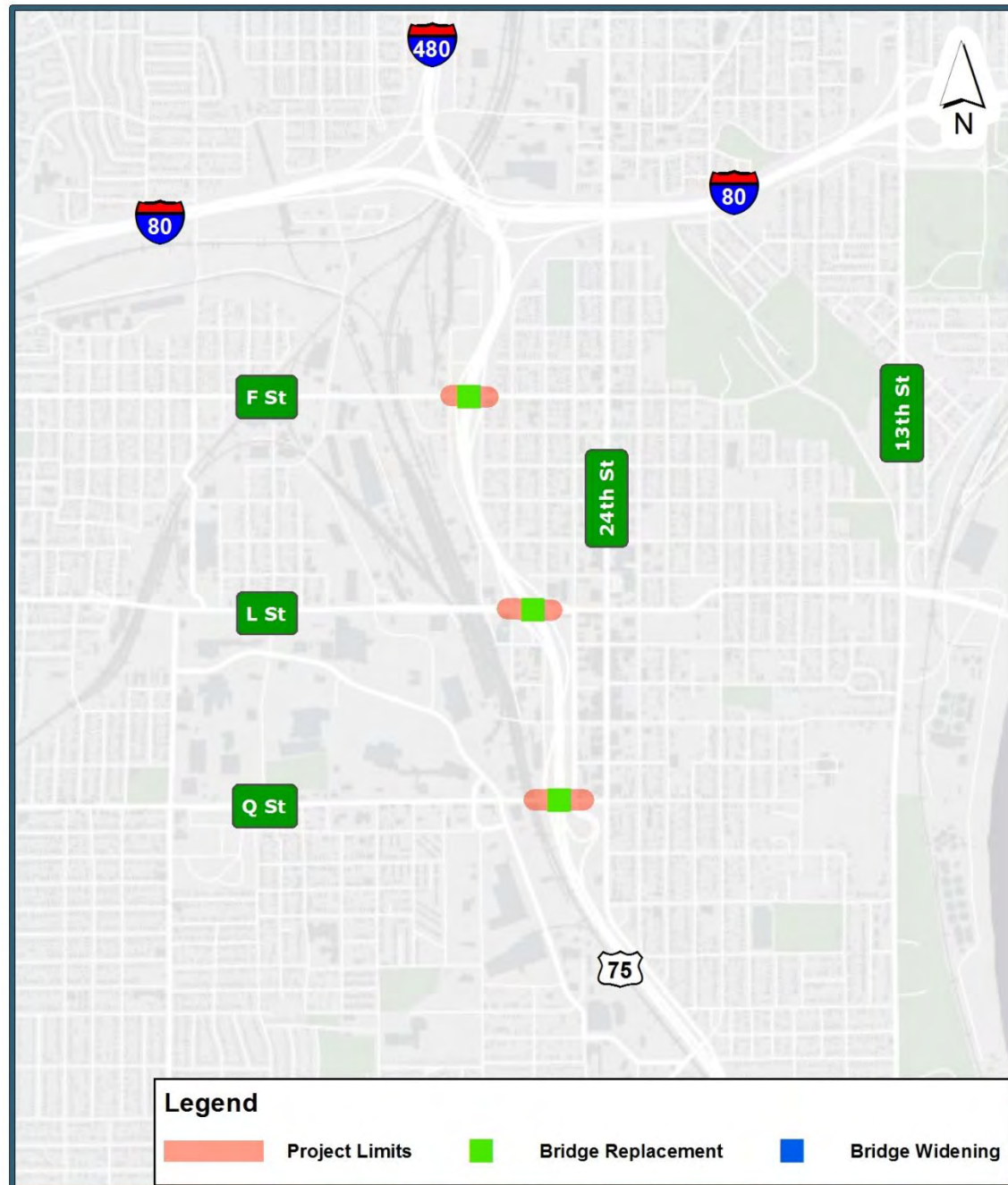

### Description

This project includes bridge replacements at F Street, L Street, and Q Street to set up the US-75 corridor to be expanded to the recommended number of lanes with 12-foot-wide shoulders. Due to the profiles of the bridges over US-75, it is anticipated that some reconstruction will occur along the arterials adjacent to the bridge replacements.

### Year of Need

- The mainline operational need on US-75 occurs in 2029 provided that E20 occurs in the interim.

### Year of Implementation

- 2029–2031

### Implementation Considerations

- E23 does NOT occur at the same time as any major system preservation activities.
- E23 would replace three bridges (S075 08663, S275 18910, and S075 08766) to provide enough lateral clearance for the recommended number of lanes for E24 and 12-foot-wide shoulders.

### Constructability

- Bridge replacements may require traffic shifts and/or lane closures on the US-75 mainline.
- Bridge reconstruction will be spaced out 1 year at a time so that two out of three east-west arterials over US-75 are provided for mobility.

### Cost Breakdown (Current Year Dollars)

The following table includes the costs (in \$ Millions) associated with the expansion:

Total	Pavement	Bridges	Walls / Barriers	Right-of-Way	Miscellaneous
\$12.11	\$4.00	\$8.11	-	-	-

**E24** US-75 Mainline Expansion: Q Street to I-80  
MP 086.33 – MP 088.10

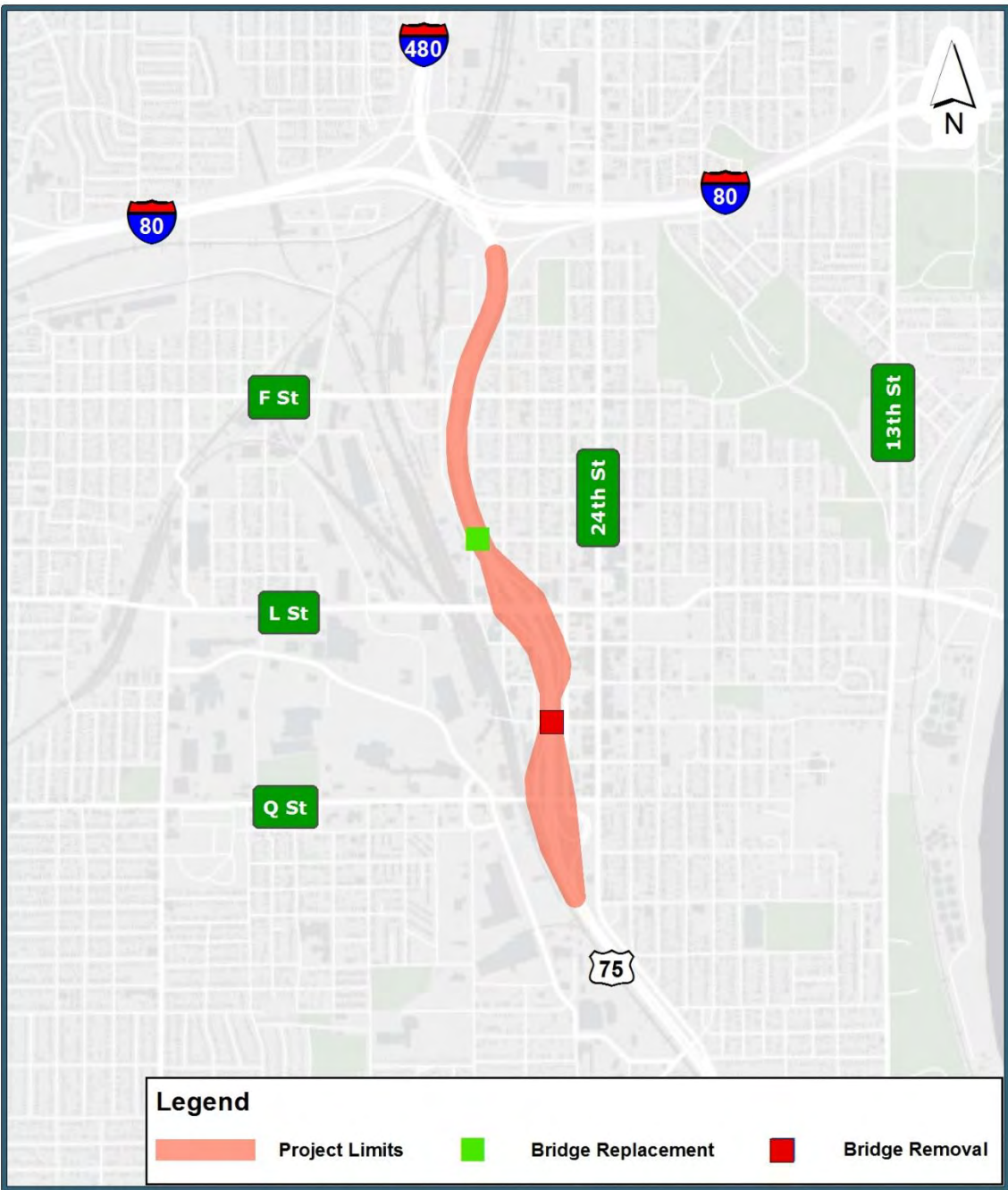

**Description**

This project (shown in yellow) adds one basic lane between Q Street and the I-80 / I-480 / US-75 system interchange ramps to and from WB I-80. This project also includes an interchange at Q Street to improve existing geometrics (removal of the loop ramp to NB US-75), removal of L Street ramps to the south to improve mainline operations, and removal of the F Street interchange due to the close proximity of F Street to the I-80 / I-480 / US-75 system interchange. The removal of the F Street interchange allows the CD road to be removed from I-80 to F Street. This project expands the interim project (E20, shown in blue) and coincides with the expansion of US-75 between Chandler Road and Q Street (E25, shown in pink).

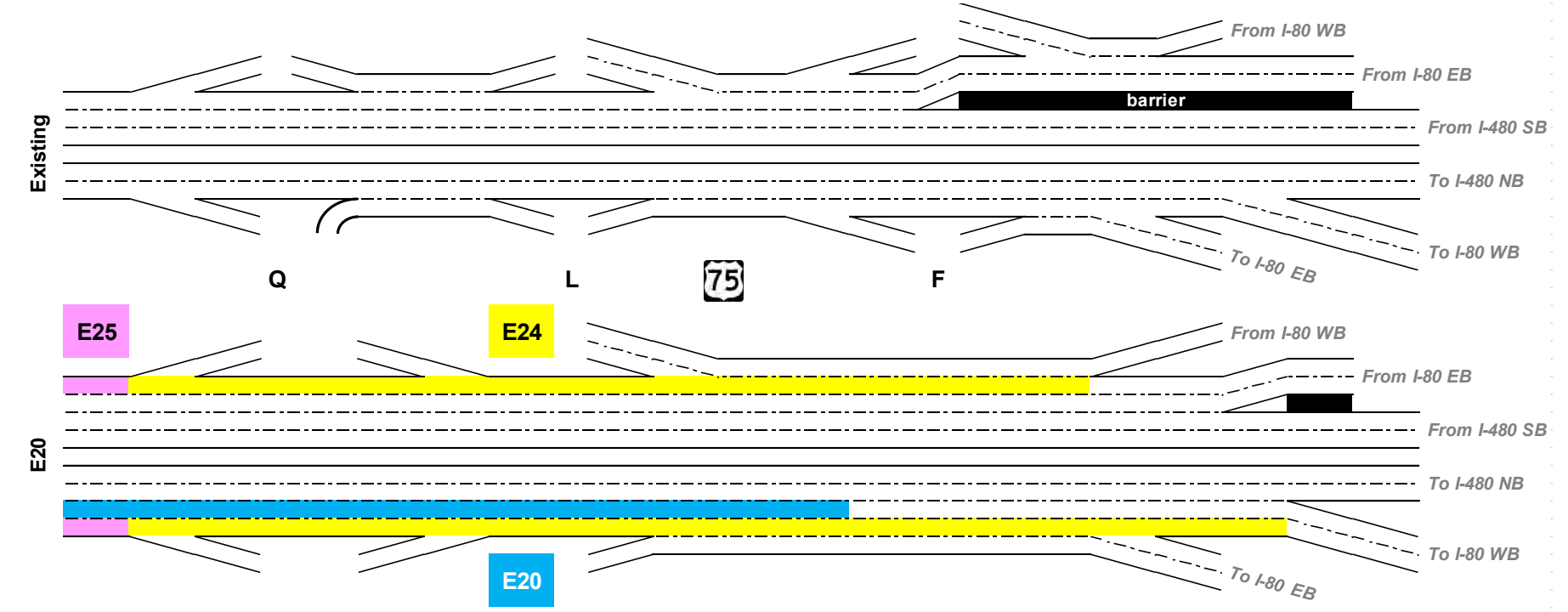

**Implementation Considerations**

- E24 occurs at the same time as the full reconstruction of US-75 from F Street to Q Street – S28.
- E24 would replace one bridge (S075 08730L) and remove one bridge (S075 08682) due to the age and condition of the structures, and because the existing structure does not provide enough lateral clearance for the recommended number of lanes and 12-foot-wide shoulders.

**Constructability**

- US-75 mainline reconstruction on alignment with significant retaining wall construction may require long-term single lane reductions on US-75.
- Temporary surfacing to maintain access at L Street and F Street should be provided during Q Street interchange reconfiguration.
  - Q Street ramp closures may be required to convert the Q Street interchange to a traditional diamond interchange.
  - The new Q Street entrance ramp may be constructed and opened prior to the closure of the existing NB loop ramp.

**Cost Breakdown (Current Year Dollars)**

The following table includes the costs (in \$ Millions) associated with the expansion:

Total	Pavement	Bridges	Walls / Barriers	Right-of-Way	Miscellaneous
\$19.1	\$7.84	\$2.48	\$7.58	-	\$1.20*

\* Miscellaneous costs include \$1.20M for signal costs at the L Street and Q Street ramp terminals.

Total cost with full reconstruction on US-75 between I-80 and Q Street (S28): \$36.68M

Year of Need	Year of Implementation
The mainline operational need occurs in 2029 provided that E20 occurs in the interim.	2032–2035



# E25

## US-75 Mainline Expansion: Chandler Road to Q Street MP 085.33 – MP 086.33

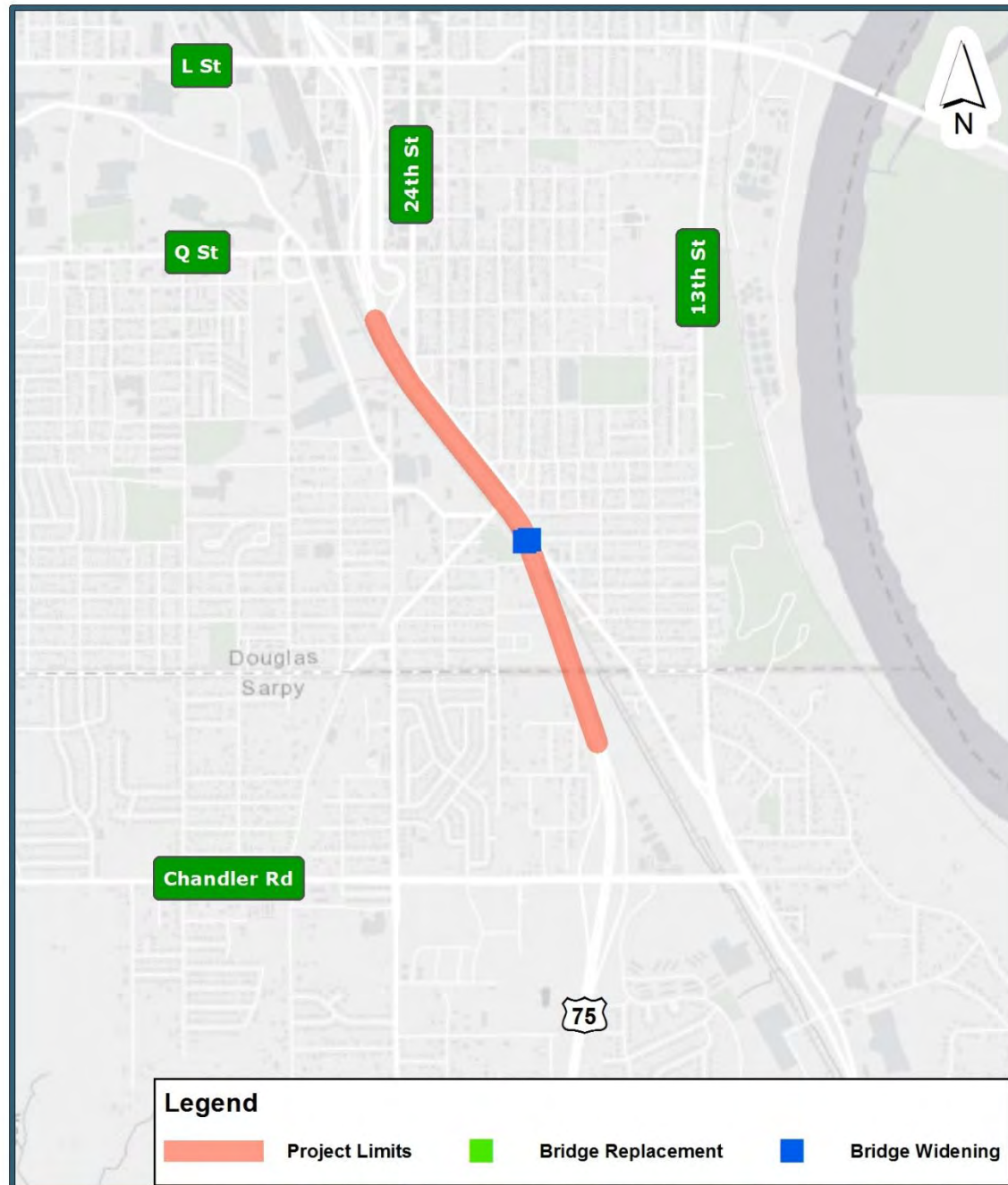

### Description

This project (shown in yellow) adds one basic lane between Chandler Street and Q Street. This project expands the interim project (E20, shown in blue) and coincides with the expansion of US-75 between I-80 and Q Street (E24, shown in pink). This project also connects with the interim expansion of US-75 between Chandler Road and Cornhusker Road to the south (E21, shown in green).

### Year of Need

- The mainline operational need occurs in 2029 provided that E20 occurs in the interim.

### Year of Implementation

- 2032–2035

### Implementation Considerations

- E25 does NOT occur at the same time as any major system preservation activities.
- E25 would widen two bridges (S075 08580L and S075 08580R) to provide enough lateral clearance for the recommended number of lanes. NDOT independently reviewed the structures and determined that the bridges can be widened to the inside to accommodate four 12-foot-wide lanes in each direction. Note that 12-foot wide shoulders will not be provided on the bridges.

### Constructability

- The US-75 mainline cross section can be widened without full-time lane closures except on the UPRR bridges. Two lanes (in each direction) will be maintained during the expansion of the UPRR bridges.
- Off-peak ramp closures may occur at the Q Street and Chandler Road ramps.

### Cost Breakdown (Current Year Dollars)

The following table includes the costs (in \$ Millions) associated with the expansion:

Total	Pavement	Bridges	Walls / Barriers	Right-of-Way	Miscellaneous
\$13.00	\$2.72	\$8.98	\$1.3	-	-

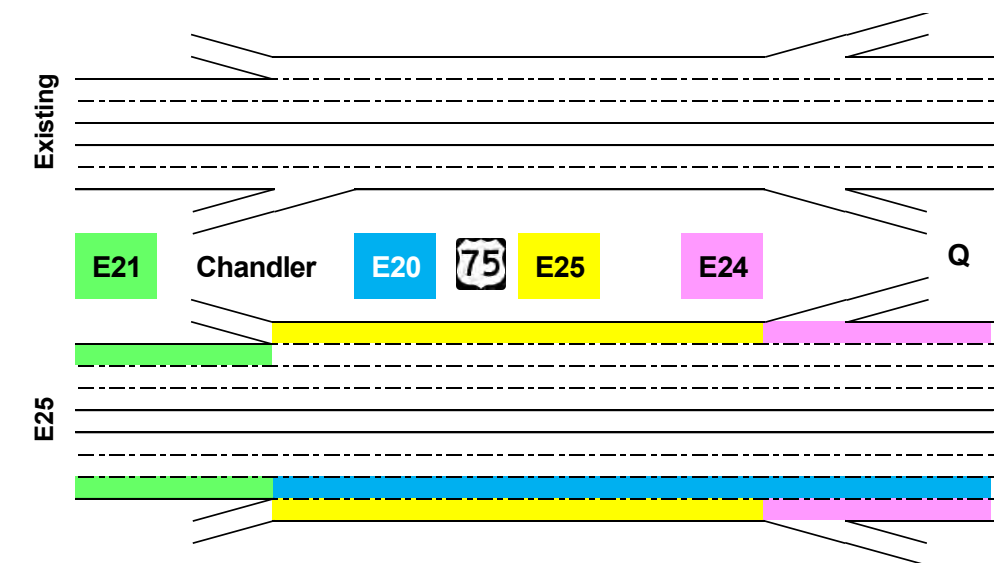

**E26** US-75 Mainline Expansion: N-370 to Chandler Road MP 081.46 – MP 085.33

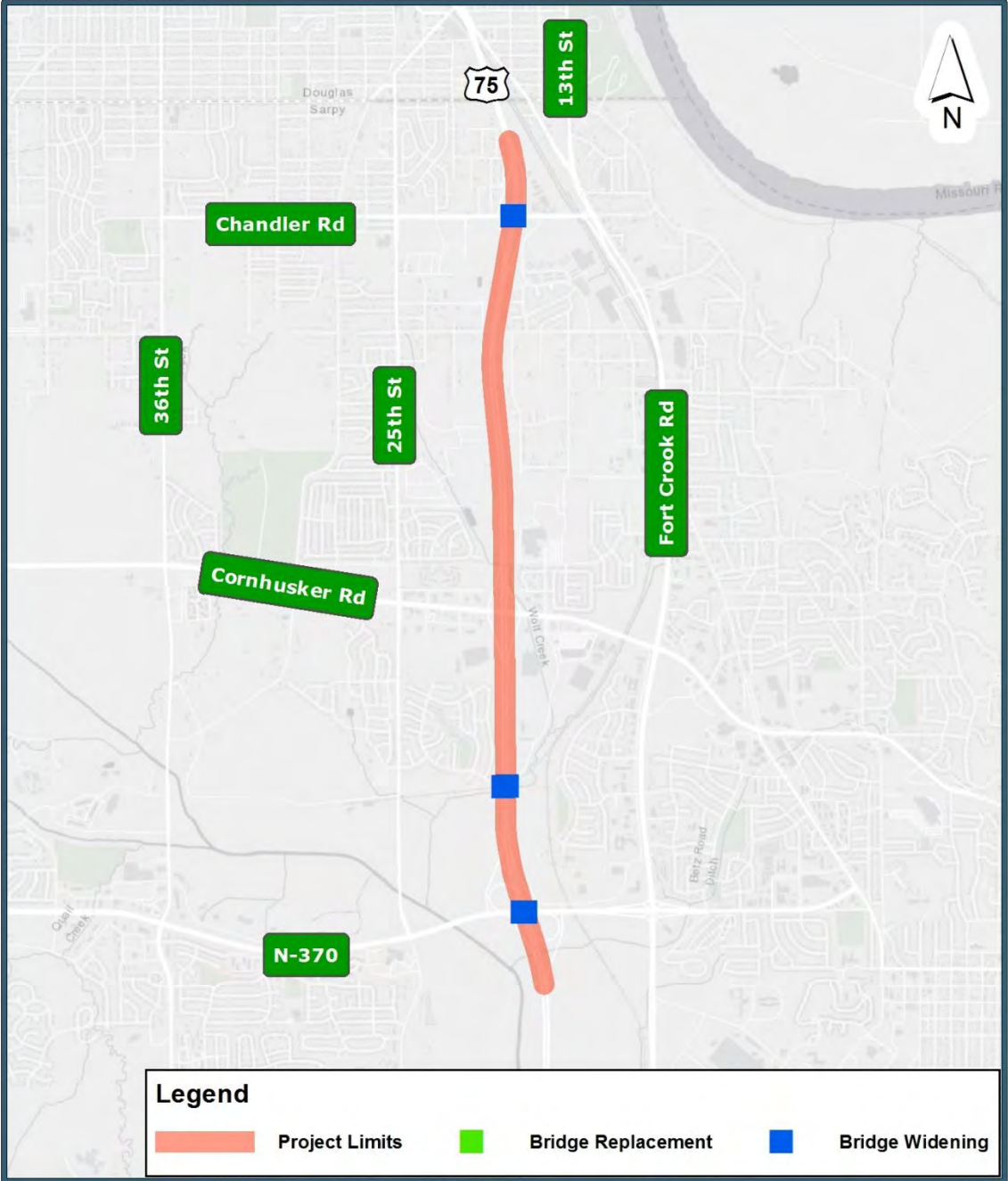

**Description**

This project (shown in yellow) builds on the interim project (E21, shown in pink) and adds one additional lane in each direction on US-75 between Chandler Road and N-370. This section of US-75 would be widened to the inside and outside to modify the existing 64-foot-wide median section to a 40-foot-wide section with a median high-tension cable barrier. This project connects with the expansion of US-75 between Chandler Road and Q Street to the north: E20 (shown in green) and E25 (shown in blue).

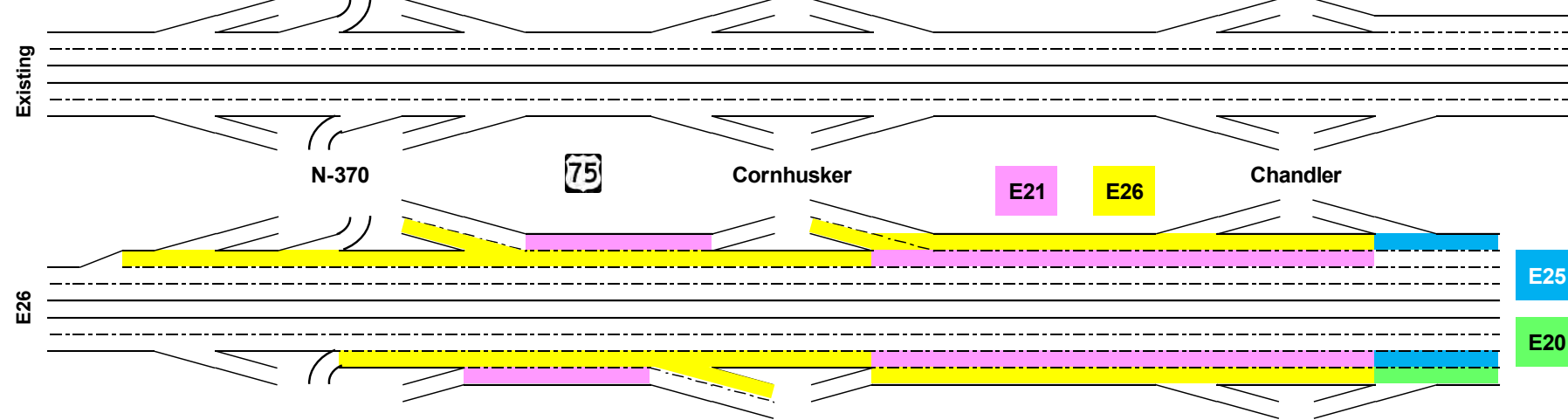

**Year of Need**

- The mainline operational need occurs in 2040 provided that E21 occurs in the interim.

**Year of Implementation**

- 2040–2042

**Implementation Considerations**

- E26 occurs at the same time as the second overlay – S26.
- E26 would widen five bridges (S075 08192L, S075 08248L, S075 08248R, S075 08495L, and S075 08495R) to provide enough lateral clearance for the recommended number of lanes and 12-foot-wide shoulders. Bridges should be widened to the inside and outside to match the proposed 40-foot-wide median section.

**Constructability**

- The US-75 mainline cross section can be widened without full-time lane closures.
- Off-peak ramp closures may occur at the Chandler Road, Cornhusker Road, and N-370 ramps.

**Cost Breakdown (Current Year Dollars)**

The following table includes the costs (in \$ Millions) associated with the expansion:

Total	Pavement	Bridges	Walls / Barriers	Right-of-Way	Miscellaneous
\$17.18	\$10.12	\$4.42	\$2.64	-	-

Total cost with an overlay on US-75 between Chandler Road and Fairview Road (S26): \$30.31M





# E27

## US-75 Interchange Expansion: Cornhusker Road DDI MP 082.99 – MP 083.50

### Description

This project expands the existing diamond configuration to a DDI at the Cornhusker Road interchange. Localized improvements and improved signal coordination at the adjacent intersections (15<sup>th</sup> Street / 21<sup>st</sup> Street and Cornhusker Road) are recommended to minimize the potential for arterial backups impacting Cornhusker Road interchange operations.

### Year of Need

- The Cornhusker Road interchange is an operational need in 2019.

### Year of Implementation

- 2040–2041

### Implementation Considerations

- E27 does NOT occur at the same time as any major system preservation activities.
- E27 does not impact the Cornhusker Road bridge and will fit on the existing bridge (S075 08323). Special consideration to the pedestrian bridge (S075 08324) is recommended to accommodate pedestrians through the DDI interchange.

### Constructability

- Much of the interchange reconstruction activities could occur outside of the US-75 mainline and avoid impacting mainline traffic.
- Complex ramp terminal staging at Cornhusker Road would be necessary to maintain full access at the Cornhusker Road interchange during reconstruction. Periods of closure for specific ramp movements are possible

### Cost Breakdown (Current Year Dollars)

The following table includes the costs (in \$ Millions) associated with the expansion:

Total	Pavement	Bridges	Walls / Barriers	Right-of-Way	Miscellaneous
\$3.20*	\$3.20	-	-	-	-

\* The total of \$3.20M accounts the portion of the interchange expansion assumed to be covered by NDOT.

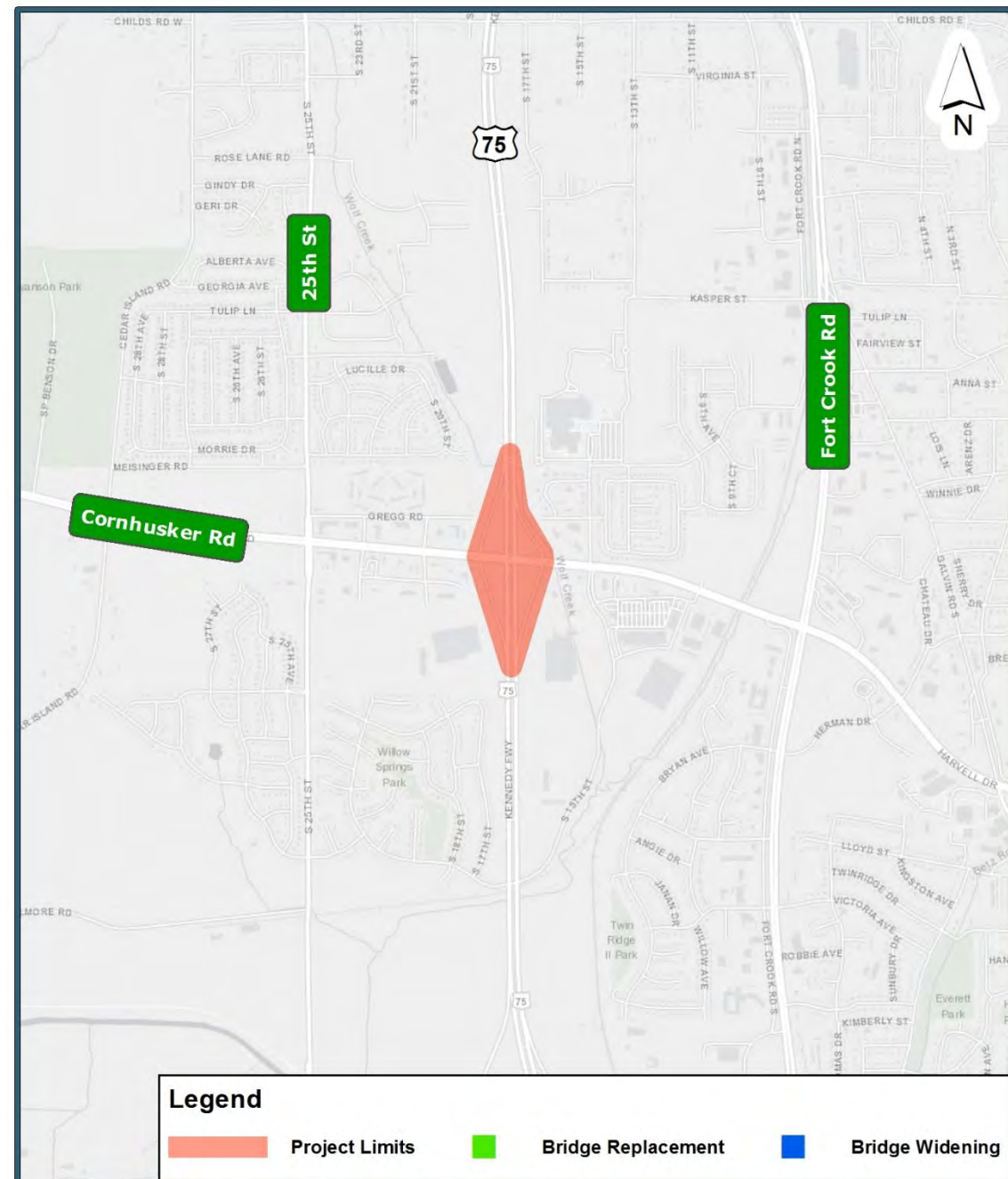

E28

US-6 WB Mainline Expansion:  
132<sup>nd</sup> Street to 144<sup>th</sup> Street  
MP 363.18 – MP 362.09

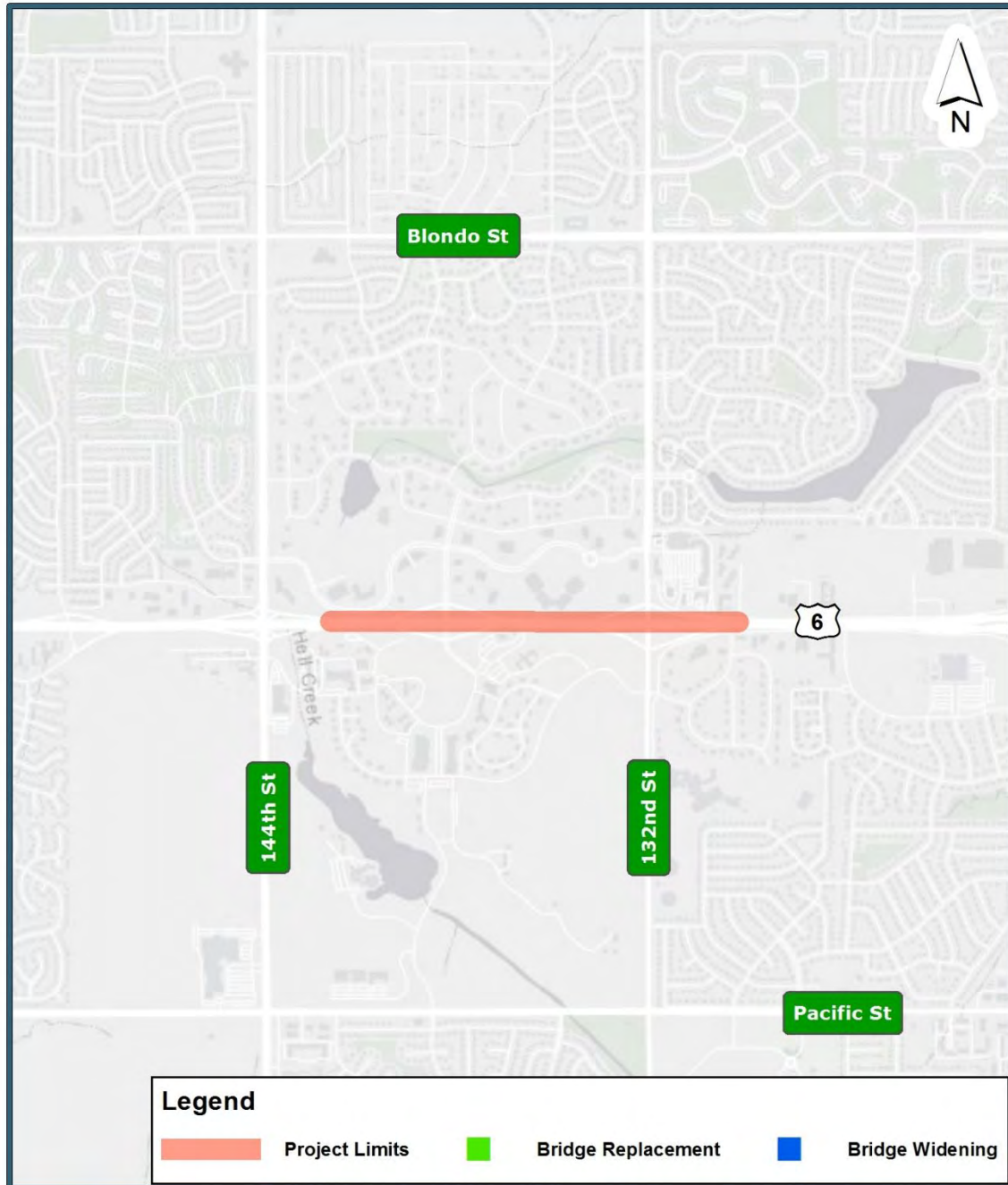

**Description**

This project adds one basic WB lane on US-6 (West Dodge Road) from 132<sup>nd</sup> Street to 144<sup>th</sup> Street. The additional lane is terminated as a two-lane exit ramp at 144<sup>th</sup> Street (without lane balance).

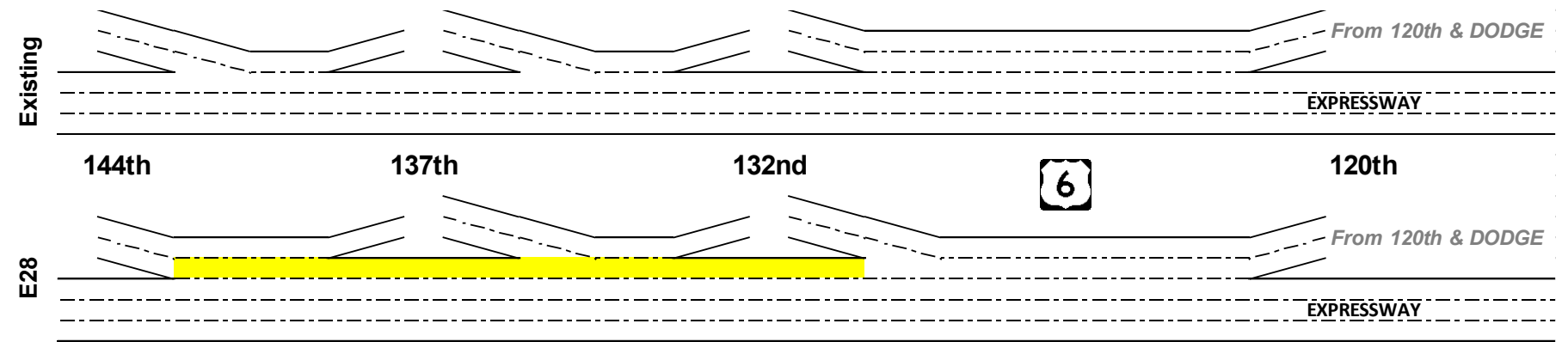

**Year of Need**

- The mainline operational need occurs in 2019.

**Year of Implementation**

- 2025–2026

**Implementation Considerations**

- E28 occurs at the same time as the second overlay – S32.
- E28 does NOT impact the 137<sup>th</sup> Street bridge (S006 36240) by allowing a shoulder exception over 137<sup>th</sup> Street.

**Constructability**

- The WB US-6 mainline widening may involve long-term single lane reductions on US-6 because of tight existing right-of-way and the need to construct variable height retaining walls along the widening.
- Ramp closures may occur at the WB 132<sup>nd</sup> Street, 137<sup>th</sup> Street, and 144<sup>th</sup> Street ramps. Ramp closure durations should be limited to much less than a construction season. Ramp closures should be sequenced to avoid concurrent closures at adjacent interchanges.

**Cost Breakdown (Current Year Dollars)**

The following table includes the costs (in \$ Millions) associated with the expansion:

Total	Pavement	Bridges	Walls / Barriers	Right-of-Way	Miscellaneous
\$3.32	\$2.33	-	\$0.88	\$0.11	-

Total cost with an overlay (WB only) on US-6 between 161<sup>st</sup> Street and 120<sup>th</sup> Street (S32): \$8.07M



# E29

## US-6 EB Mainline Expansion: 137<sup>th</sup> Street to 132<sup>nd</sup> Street MP 362.22 – MP 363.25

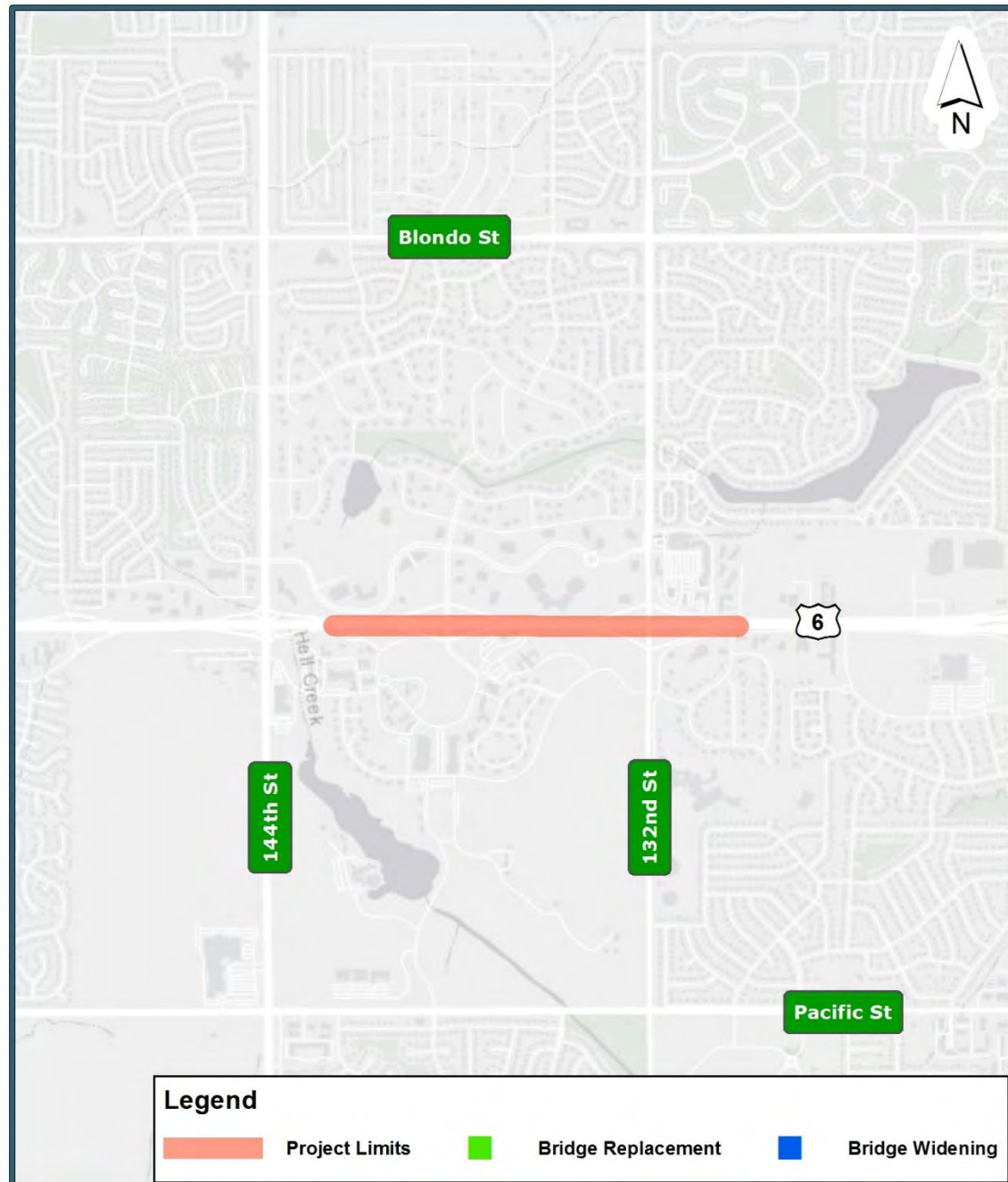

### Description

This project adds one basic EB lane on US-6 (West Dodge Road) from 137<sup>th</sup> Street to 132<sup>nd</sup> Street. The additional lane is added by changing the 137<sup>th</sup> Street two-lane exit ramp to a single-lane diverge. The additional lane is terminated by merging the EB 132<sup>nd</sup> Street entrance ramp into the four-lane section.

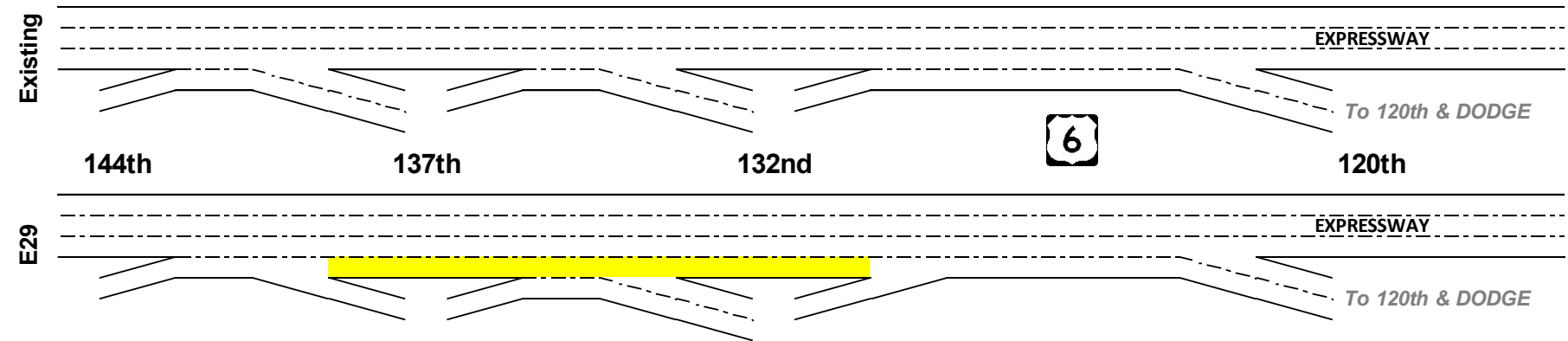

### Year of Need

- The mainline operational need occurs in 2019.

### Year of Implementation

- 2025–2026

### Implementation Considerations

- E29 occurs at the same time as the second overlay – S32.
- E29 does NOT impact the 137<sup>th</sup> Street bridge (S006 36240) by allowing a shoulder exception over 137<sup>th</sup> Street.

### Constructability

- The EB US-6 mainline widening may involve long-term single lane reductions on US-6 because of tight existing right-of-way and the need to construct variable height retaining walls along the widening.
- Ramp closures may occur at the 132<sup>nd</sup> Street and 137<sup>th</sup> Street exit and entrance ramps. Ramp closure durations should be limited to much less than a construction season. Ramp closures should be sequenced to avoid concurrent closures at adjacent interchanges.

### Cost Breakdown (Current Year Dollars)

The following table includes the costs (in \$ Millions) associated with the expansion:

Total	Pavement	Bridges	Walls / Barriers	Right-of-Way	Miscellaneous
\$5.58	\$2.33	-	\$2.88	\$0.37	-

Total cost with an overlay (EB only) on US-6 between 161<sup>st</sup> Street and 120<sup>th</sup> Street (S32): \$10.33M

**E30**

**US-6 Interchange Expansion:  
192<sup>nd</sup> Street DDI  
MP 357.64 – MP 358.16**

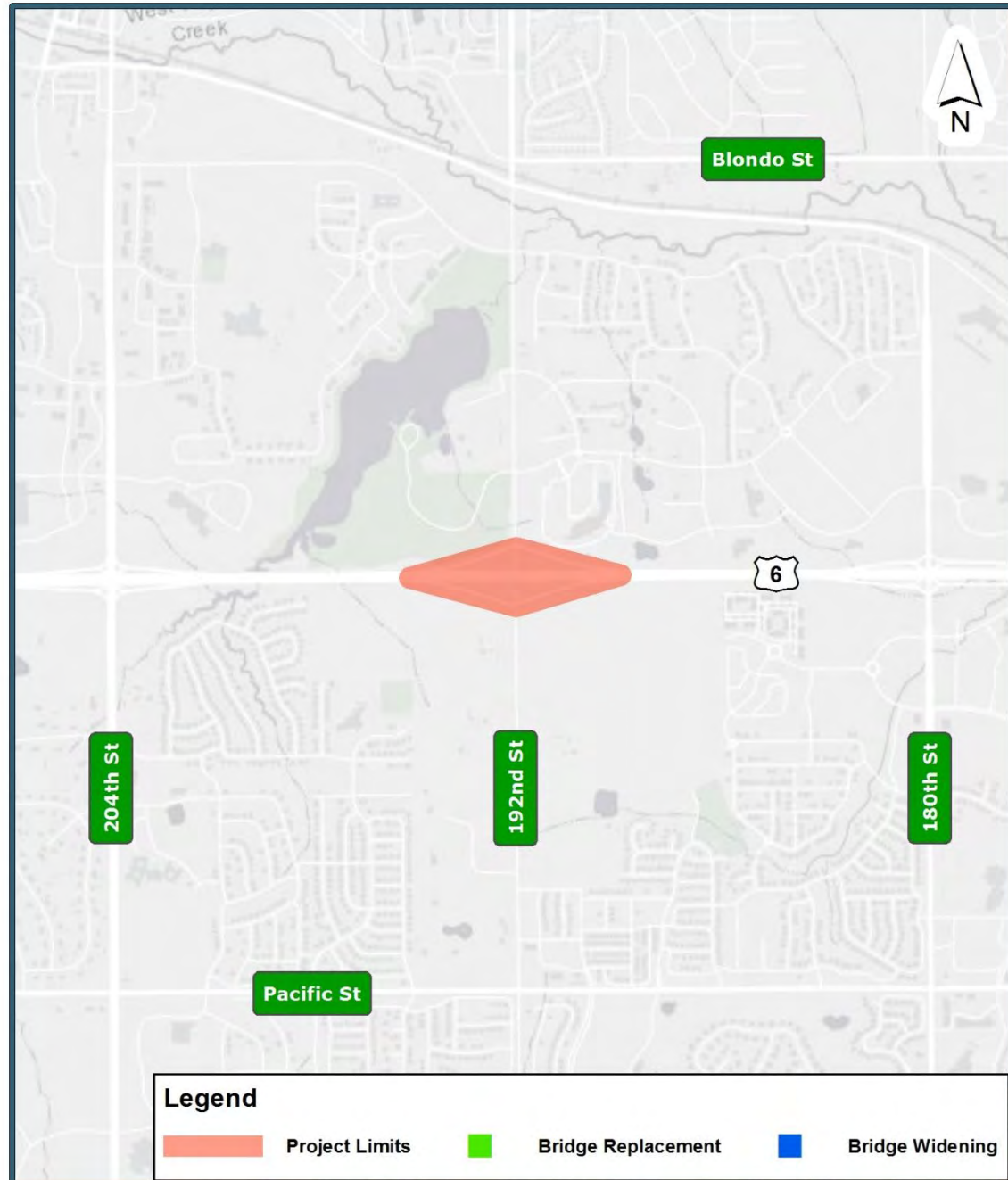

**Description**

This project is included in the BNA and expands the existing diamond configuration to a DDI at the 192<sup>nd</sup> Street interchange. Localized improvements along 192<sup>nd</sup> Street are recommended to minimize the potential for arterial backups impacting 192<sup>nd</sup> Street interchange operations.

**Year of Need**

- The year of need is not applicable. The needs analysis was performed by others, and the project is included in the BNA.

**Year of Implementation**

- 2025–2026

**Implementation Considerations**

- E30 does NOT occur at the same time as any major system preservation activities.
- E30 does NOT impact the 192<sup>nd</sup> Street bridge (S006 35790) by providing a DDI concept that fits within the existing lateral clearances.

**Constructability**

- Much of the interchange reconstruction activities could occur outside of the US-6 mainline and avoid impacting mainline traffic.
- Complex ramp terminal staging at 192<sup>nd</sup> Street would be required to maintain full access at the 192<sup>nd</sup> Street interchange during reconstruction. Periods of closure for specific ramp movements are possible.

**Cost Breakdown (Current Year Dollars)**

The following table includes the costs (in \$ Millions) associated with the expansion:

Total	Pavement	Bridges	Walls / Barriers	Right-of-Way	Miscellaneous
\$10.00*	Cost Determined by NDOT				

\* Not included in the Constrained Implementation Plan since this project is funded by the BNA.



# E31

## US-6 Mainline Expansion: 168<sup>th</sup> Street to 108<sup>th</sup> Street MP 359.91 – MP 364.61

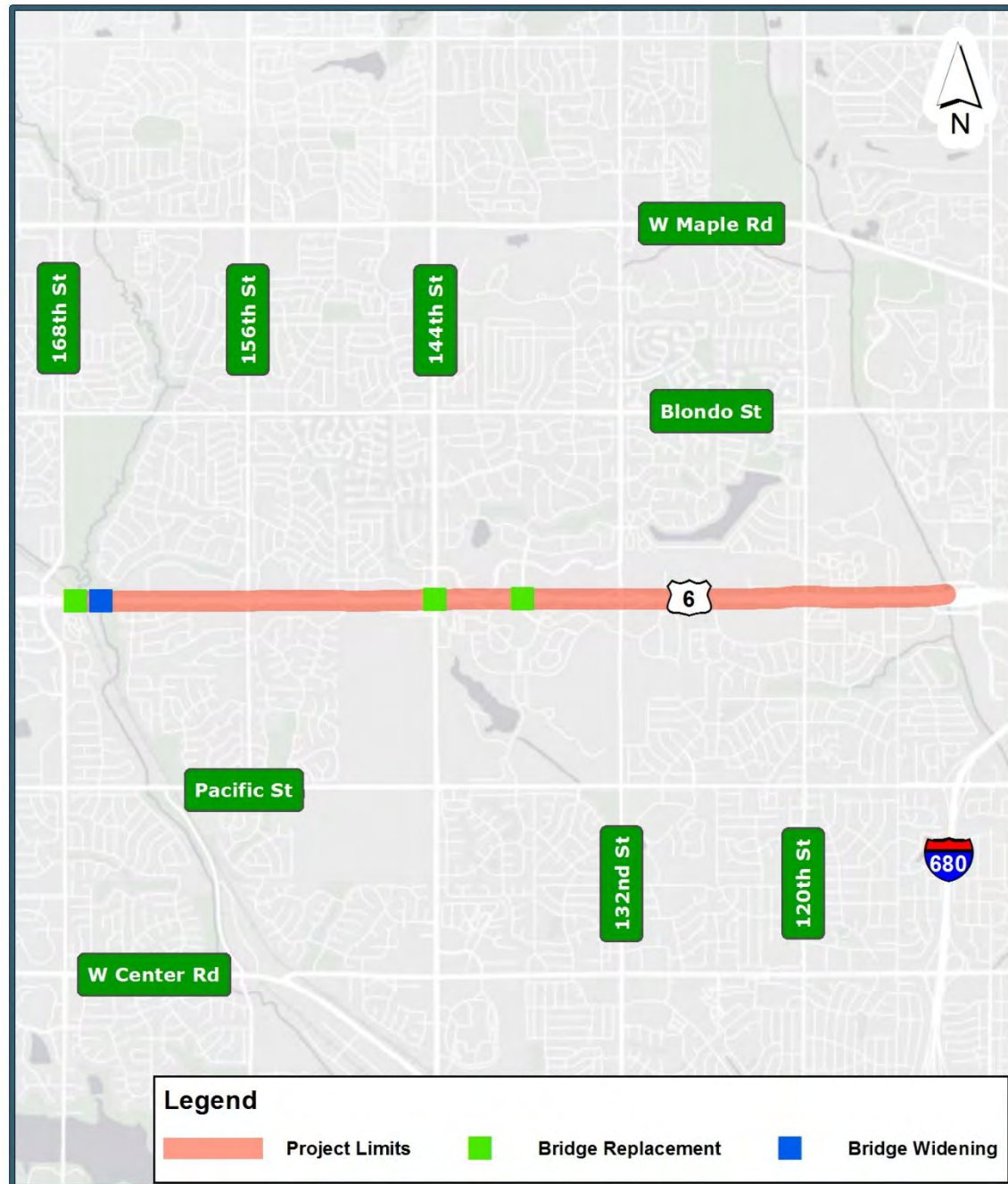

### Description

This project (shown in yellow) expands the WB West Dodge Road corridor to five basic lanes between 120<sup>th</sup> Street and 156<sup>th</sup> Street, and four basic lanes west of 156<sup>th</sup> Street. In the EB direction, four basic lanes are provided east of 168<sup>th</sup> Street. Auxiliary lanes are provided between service interchange ramps. This project also includes providing an additional lane on the WB West Dodge Road Expressway bridge. This project builds on the interim project (E28, shown in blue) and connects with the expansion of the West Dodge Road mainline between 137<sup>th</sup> Street and 132<sup>nd</sup> Street (E29, shown in green) and expansion of the West Dodge Road mainline west of 168<sup>th</sup> Street (E32, shown in pink).

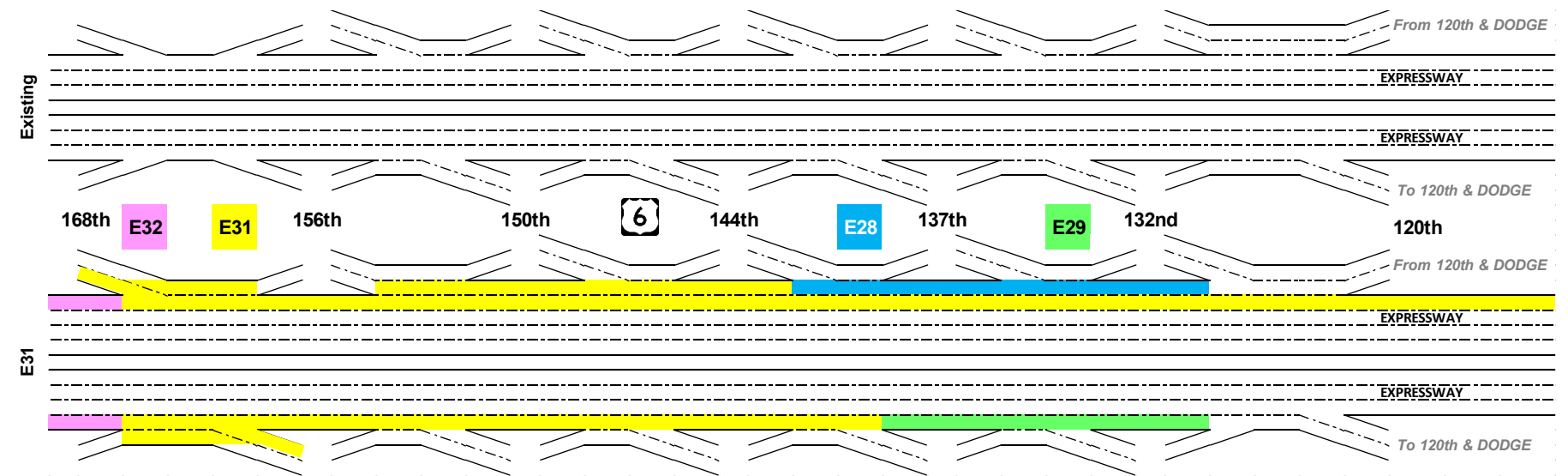

### Implementation Considerations

- E31 occurs at the same time as the full reconstruction of US-6 from 160<sup>th</sup> Street to 120<sup>th</sup> Street – S32.
- E31 would replace three bridges (S006 35999, S006 36192, and S006 36240) and widen one bridge (S006 36012) to provide enough lateral clearance for the recommended number of lanes, with 12-foot-wide shoulders.

### Constructability

- US-6 mainline reconstruction on alignment may require long-term single lane reductions on US-6 because of tight existing right-of-way and the need to construct variable height retaining walls along the widening.
- 144<sup>th</sup> Street and 137<sup>th</sup> Street ramp closures may be required to replace the bridges at each interchange. These bridges will be spaced out 1 year at a time to provide MOT benefits for each other during construction.
- Bridge replacements may require traffic shifts and/or lane closures on the US-6 mainline.
- Ramp closures would be required for ramp tie-ins and ramp reconstruction at all impacted service interchanges from 120<sup>th</sup> Street to 168<sup>th</sup> Street.
- The frontage road shift (to the north) for WB US-6 expansion between 120<sup>th</sup> Street and 132<sup>nd</sup> Street will require short-term frontage road closures.

### Cost Breakdown (Current Year Dollars)

The following table includes the costs (in \$ Millions) associated with the expansion:

Total	Pavement	Bridges	Walls / Barriers	Right-of-Way	Miscellaneous
\$52.93	\$18.92	\$24.09	\$0.48	\$0.44	\$5.00

\* Miscellaneous costs include \$5.00M for drainage costs associated with the widening.

Total cost with full reconstruction on US-6 between 161<sup>st</sup> Street and 120<sup>th</sup> Street (S32): \$93.28M

Year of Need	Year of Implementation
The mainline operational need occurs in 2019. The interim expansions (E28 and E29) provide improved throughput during the peak periods, but an overall LOS need will still exist.	2036–2040

**E32** **US-6 Mainline Expansion: 204<sup>th</sup> Street to 168<sup>th</sup> Street**  
MP 357.07 – MP 359.91

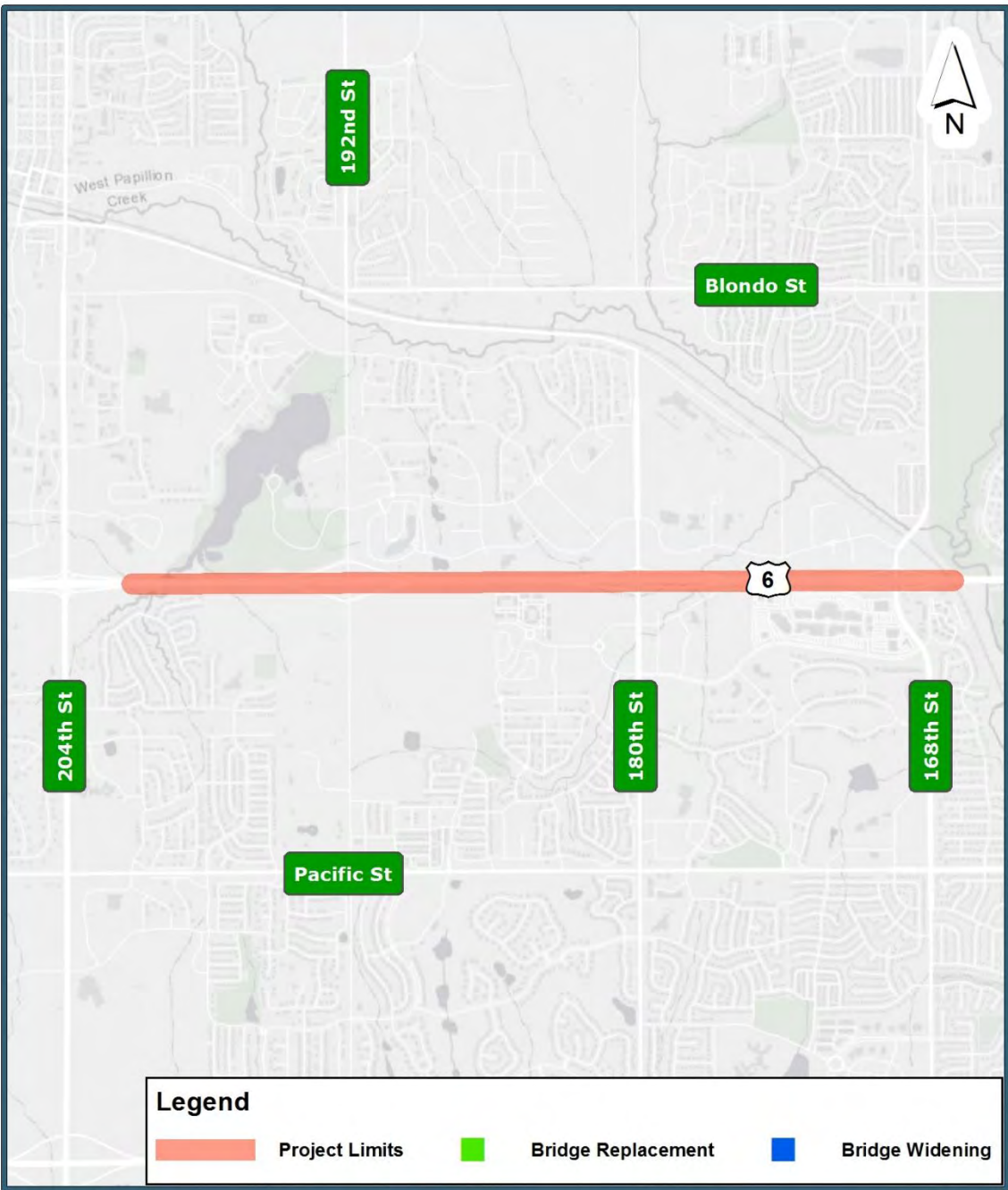

**Description**

This project (shown in yellow) expands the West Dodge Road corridor to four basic lanes between 192<sup>nd</sup> Street and 168<sup>th</sup> Street, and three basic lanes between 204<sup>th</sup> Street and 192<sup>nd</sup> Street. Included in this project is the expansion from a one-lane EB entrance ramp to a two-lane EB entrance ramp at 204<sup>th</sup> Street. The tapers to and from a three-lane section over 204<sup>th</sup> Street are removed to provide two-lane ramps at 204<sup>th</sup> Street with minimal widening to the mainline. This project connects with the expansion east of 168<sup>th</sup> Street (E31, shown in blue).

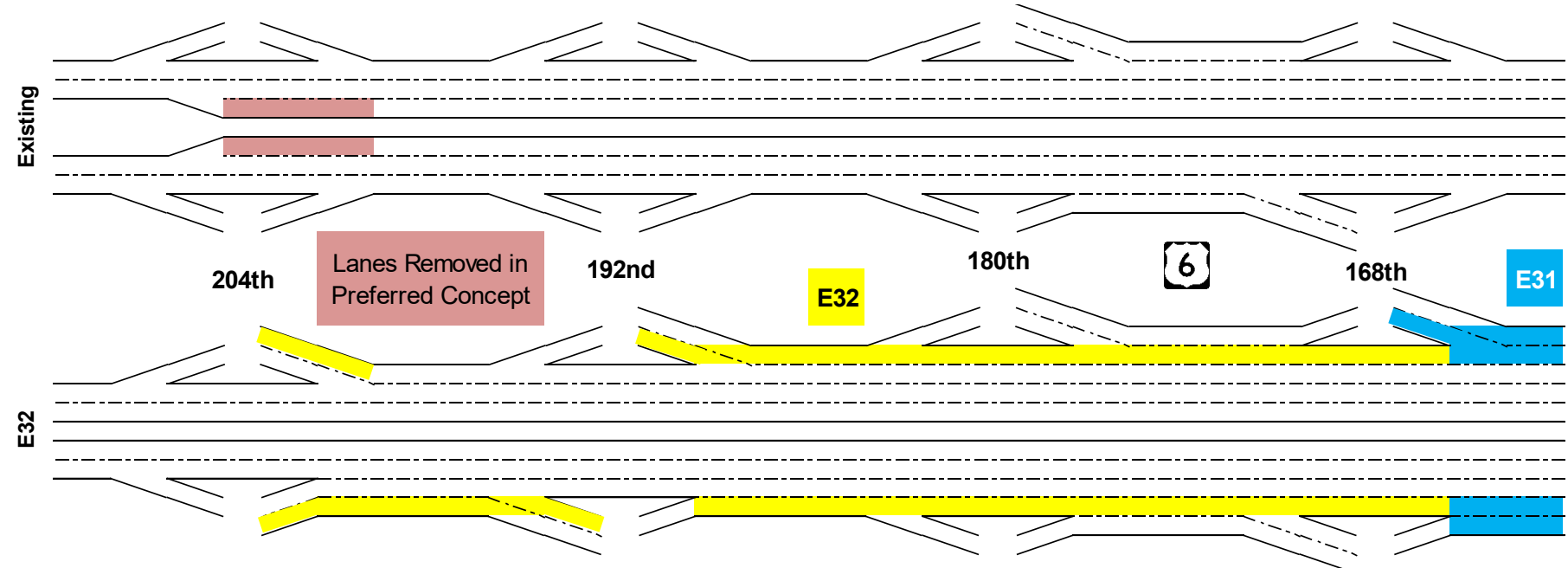

**Implementation Considerations**

- E32 occurs at the same time as the first overlay – S31.
- E32 does NOT require any bridge widening or replacement.

**Constructability**

- The US-6 mainline widening may require long-term single lane reductions on US-6 in a few select segments, such as EB US-6 between 180<sup>th</sup> Street and 168<sup>th</sup> Street, where existing right-of-way is narrow and a retaining wall between West Dodge and the adjacent frontage road is needed. Elsewhere, the widening should not involve full-time lane closures.
- Ramp closures may occur at the 204<sup>th</sup> Street, 192<sup>nd</sup> Street, 180<sup>th</sup> Street, and 168<sup>th</sup> Street interchanges for ramp realignments to accommodate the mainline widening. Closure durations should be limited to much less than a construction season.

**Cost Breakdown (Current Year Dollars)**

The following table includes the costs (in \$ Millions) associated with the expansion:

Total	Pavement	Bridges	Walls / Barriers	Right-of-Way	Miscellaneous
\$8.98	\$7.99	-	-	\$0.99	-

Total cost with an overlay on US-6 between 204<sup>th</sup> Street and 161<sup>st</sup> Street (S31): \$21.35M

Year of Need	Year of Implementation
The mainline operational need is dependent on the timing of the expansion of West Dodge Road to the east.	2037–2039



# E33

## I-680 / US-6 System Interchange Expansion: WB Weave Improvements Near US-6 MP 365.04

### Description

This project expands the NB I-680 to WB West Dodge Road directional ramp to three lanes. This project keeps the existing SB I-680 ramp but channelizes the movement so that it can be used only to access the WB West Dodge Road Expressway. An additional ramp is braided underneath the NB I-680 to WB West Dodge Road directional ramp and provides SB I-680 access to Old Mill.

### Year of Need

- The I-680 / West Dodge Road system interchange is an operational need in 2019.

### Year of Implementation

- 2026–2027

### Implementation Considerations

- E33 does NOT occur at the same time as any major system preservation activities.
- E33 would widen one bridge (S680 00315) to provide enough lateral clearance for three lanes on the NB I-680 to WB West Dodge Road directional ramp. The bridge would be widened to the north due to the superelevation of the structure.

### Constructability

- The SB I-680 to WB local West Dodge Road ramp could be constructed first off alignment.
- SB I-680 traffic could be shifted to the new alignment with ramp access limited to WB local West Dodge Road.
- Additional pavement to modify the existing SB I-680 to WB West Dodge Road lane addition to a merge, and barriers to remove the weave, could be constructed with NB I-680 traffic to WB West Dodge Road access limited to the WB Expressway.
- Off-peak closures may occur at the I-680 / West Dodge Road system interchange.

### Cost Breakdown (Current Year Dollars)

The following table includes the costs (in \$ Millions) associated with the expansion:

Total	Pavement	Bridges	Walls / Barriers	Right-of-Way	Miscellaneous
\$4.02	\$3.20	\$0.82	-	-	-

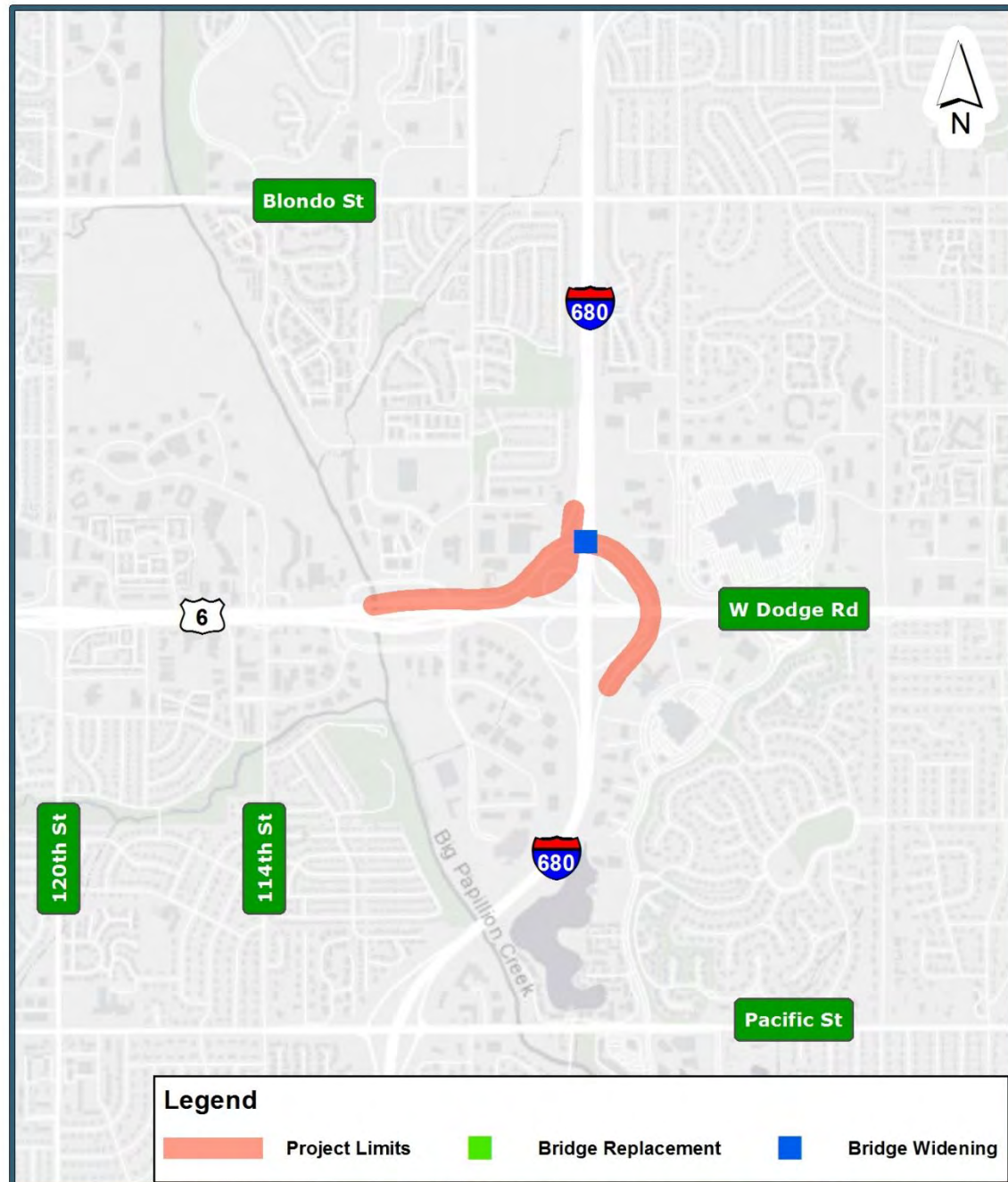

## Chapter 5 - Outreach

This chapter summarizes the outreach activities that were conducted during Phase 3.

### MTIS Management Committee Meetings

The Management Committee is responsible for the day-to-day management of MTIS. Members include representatives from NDOT and MAPA. Periodic progress meetings with this committee were held during Phase 3 to review study progress and provide direction to the Study Team.

### MTIS Executive Committee Meetings

The Executive Committee is responsible for high-level decisions regarding study scope, study schedule, and study recommendations. Members include representatives from NDOT, MAPA, the City of Omaha, and the Federal Highway Administration (FHWA). As of September 2019, a meeting with the Executive Committee had not yet occurred but could still be scheduled at the direction of NDOT.

### Concept Proofing and Implementation Plan Workshops

Eleven workshops were conducted with key NDOT staff over the course of Phase 3 to discuss and coordinate the concept proofing process, the identification of the recommended concepts, and the development of the two alternative implementation plans. These workshops were held on the following dates:

- October 23, 2017
- December 19, 2017
- February 6, 2018
- April 2, 2018
- May 10, 2018
- June 26, 2018
- July 10, 2018
- July 16, 2018
- September 11, 2018
- September 27, 2018
- October 16, 2018

### Regulatory Agency Meeting

The Study Team gave a presentation to representatives from various regulatory agencies at the February 20, 2018, NDOT interagency meeting. The intent of the meeting was to present a high-level overview of MTIS and what the agencies can expect in the future, and to identify any concerns or issues to be addressed in future environmental documentation. No specific comments or questions were offered by the regulatory agencies at the meeting. One follow-up comment form was received from the Nebraska Department of Environmental Quality.

### MAPA MPO Certification Review

Study Team staff provided an overview of MTIS activities to representatives from FHWA and the Federal Transit Administration on July 25, 2018, as part of MAPA's Metropolitan Planning Organization (MPO) Certification Review. This review, which occurs every 3 years, evaluates the effectiveness of the MPO's transportation planning process and verifies that the MPO is complying with federal regulations.

### Stakeholder Meeting

A coordination meeting with staff from the City of Omaha and MAPA was held on August 8, 2018. The purpose of the meeting was to obtain input from the City of Omaha on the concepts and sub-options being considered. The following topics were discussed:

- 42<sup>nd</sup> Street interchange configuration options
- DDI concepts at 84<sup>th</sup> Street, 72<sup>nd</sup> Street, 60<sup>th</sup> Street, and Pacific Street
- F Street interchange removal
- Potential lane reduction from local West Dodge Road to the WB West Dodge Road Expressway
- Channelization on West Dodge Road between 132<sup>nd</sup> Street and 120<sup>th</sup> Street to eliminate weaving
- Ramp metering for all corridors

### NDOT Leadership Meeting

A workshop with NDOT's Deputy Directors and Division Heads was held on February 4, 2019. The purpose of the workshop was to:

- Share the Study Team's understanding of system preservation needs and request additional feedback from the applicable NDOT Divisions.
- Share the expansion needs based on expected traffic growth.
- Request feedback on the feasibility of the Constrained Implementation Plan.

### Public Involvement

No public meetings have been held as part of MTIS. During Phase 2, public input to MTIS was provided via surveys and meetings conducted by MAPA during the update of its LRTP. The public was asked to prioritize goals and strategies for the region's transportation needs. This input was reflected in the development of the Preferred Regional Strategy Package. NDOT is considering holding a web-based public meeting for MTIS to solicit public feedback on the recommended freeway concepts and the Constrained Implementation Plan. However, this meeting has not yet been scheduled.

### Coordination with Other Studies and Projects

Numerous ongoing and past regionally significant studies have relevance to MTIS. The Study Team reviewed each of these studies to determine which studies would provide coordination opportunities during MTIS. Several studies were identified as opportunities to coordinate shared goals, objectives, and system performance analysis. These studies are summarized in the Phase 2 report.





## Chapter 6 - Summary

Phase 3 of MTIS focused solely on the freeway corridors of the MTIS network to address the following questions:

- What is the “vision” for the freeway system in the Omaha metropolitan area?
- How are we going to get there?

Phase 3 included further development, though limited in scope, of critical areas of the freeway corridor-level concepts and sub-options from Phase 2. All of the concepts and sub-options carried forward from Phase 2 generally add capacity to the corridors through the addition of mainline general purpose lanes and/or auxiliary lanes or would address weaving or other operational issues through the reconfiguration of interchanges and/or ramps. Concept proofing involved the development of conceptual alignments, profiles, and/or cross sections in limited locations to the extent necessary to establish a reasonable level of confidence in concept feasibility and to permit identification of right-of-way impacts.

Key elements of the recommended concept for each freeway corridor include the following:

### **I-80**

- Addition of one or two mainline lanes in each direction plus auxiliary lanes, depending on location
- DDIs at the N-31, N-370, N-50, and L Street interchanges

### **I-480**

- Addition of one mainline lane in each direction between I-80 and Harney Street

### **I-680**

- Addition of one or two mainline lanes in each direction, depending on location
- Consistency with NDOT’s IJR recommendation from West Maple Road through Blair High Road, with parclo at Fort Street and Blair High Road
- DDI at Pacific Street

### **US-75 (Kennedy Freeway)**

- Follows recommendations from the 2001 Kennedy Freeway Planning Study except for the following:
  - Full interchange at Q Street with minor side street reconfiguration
  - DDI at Cornhusker Road
- Permanent closure of the F Street interchange

### **US-6 (West Dodge Road)**

- Addition of one mainline lane in each direction plus auxiliary lanes, depending on location
- Narrow lanes and shoulders to provide four WB lanes on elevated portion of West Dodge Road Expressway (two lanes from WB West Dodge Road and two lanes from I-680)
- DDI at 192<sup>nd</sup> Street
- Elimination of the I-680 / WB West Dodge Road system interchange weaving section

### **Other Strategies**

The following non-traditional strategies were also evaluated further in Phase 3, either as alternatives to the recommended freeway concepts or as complimentary features of the recommended freeway concepts. None of these strategies have

been directly included in the recommended freeway plan. However, each should continue to be evaluated for possible implementation in the future.

- Hard Shoulder Running
- Bus on Shoulder
- Ramp Metering
- Dynamic Lane Assignment

### **Implementation Plan**

Two alternative implementation plans were developed in Phase 3 that address the system preservation needs of the freeway system as well as the operational needs of the freeway system. Both implementations plans were developed for a period beginning in the year 2025 and extending out to the year 2080. The year 2025 was identified as the first year for expansion projects based, in part, on the assumption that funding will not be available for these projects prior to the year 2025 and the assumption that design, environmental studies, and right-of-way acquisition will need to be performed prior to construction. The year 2080 was selected to include the next total reconstruction of each of the freeway corridors.

The first implementation plan, referred to as the Needs-Based Implementation Plan, provides a strategy focused on addressing the operational needs of the freeway system when the operational needs are expected to occur (or as soon as possible thereafter), without regard to funding capacity. Given that many of the expansion projects are needed today, these projects are generally front-loaded in the schedule. All of the expansion projects are assumed to be completed prior to the year 2040.

The second implementation plan, referred to as the Constrained Implementation Plan, provides a more balanced strategy that considers other variables in addition to when the expansion projects are needed. Compared to the Needs-Based Implementation Plan, the Constrained Implementation Plan generally spreads the expansion projects across the years 2025 through 2045. More consideration was also given to predecessor and successor relationships between expansion projects. In some cases, these relationships resulted in expansion projects being scheduled much longer after the project is needed based on operations. However, all of the expansion projects are assumed to be completed by the year 2043.

NDOT identified the type and time frame for each system preservation project. System preservation project types include full reconstruction, mill and overlay, diamond grinding, and minor maintenance activities such as joint sealing, crack sealing, chip sealing, and joint and panel repair. The total cost for the recommended system preservation projects within the Omaha metropolitan area freeway system for the years 2025 through 2080 is estimated to be \$1.87B in today’s dollars and \$6.23B in Year of Expenditure dollars.

The expansion projects developed during Phase 3 represent the incremental steps necessary to implement the overall recommended concepts. These projects were developed jointly by NDOT and the Study Team. The total cost for the recommended expansion projects within the Omaha metropolitan area freeway system for the years 2025 through 2080 is estimated to be \$396M in today’s dollars and \$639M in Year of Expenditure dollars.

## Appendices

The following information is included in the appendices.

### ***Appendix A: Environmental Resources***

#### ***Appendix B: I-80***

- Recommended Concept Figures
- Typical Sections

#### ***Appendix C: I-480***

- Recommended Concept Figures
- Typical Sections

#### ***Appendix D: I-680***

- Recommended Concept Figures
- Typical Sections

#### ***Appendix E: US-75 (Kennedy Freeway)***

- Recommended Concept Figures
- Typical Sections

#### ***Appendix F: US-6 (West Dodge Road)***

- Recommended Concept Figures
- Typical Sections



## Appendix A - Environmental Resources

### *Environmental Resources Tables:*

- Table A.1: I-80 and I-480
- Table A.2: I-680
- Table A.3: US-75 (Kennedy Freeway) and US-6 (West Dodge Road)

**Table A.1 I-80 and I-480 Existing Environmental Resources**

Corridor	Segment	Environmental Comparative Data										Environmental Summary
		Wetlands & WOUS	T&E Species	Floodplains & Water Resources	Hazardous Materials	Historical Resources	Section 4(f) & Section 6(f) Resources	Farmland	Environmental Justice	Noise-Sensitive Receivers	Other Resources of Concern	Comments
I-80	<b>Alternative 1</b>	0.33 ac NWI-mapped emergent wetland 6.19 ac NWI-mapped riverine wetland 13,341 linear feet NHD Waterways	Corridor is within the range of American ginseng, bald eagle, interior least tern, lake sturgeon, northern long-eared bat, pallid sturgeon, piping plover, river otter, sturgeon chub, and western prairie fringed orchid.  Suitable habitat for northern long-eared bat may be present in trees throughout the corridor.  Suitable habitat for river otter may be present along South Papillion Creek and Papillion Creek.  No suitable habitat is present for the other listed species.	56.82 ac floodplain 18.28 ac floodway 133.23 ac MUD Wellhead Protection Area 3 impaired waters (Big Papillion Creek [Recreation-Bacteria], Little Papillion Creek [Recreation-Bacteria], and West Papillion Creek) 35 wells	24 NDEQ listed sites 45 EPA Facilities LST sites: 4 IWM sites: 1 SF sites: 1	No districts or structures impacted.	2.58 acres of 6 parks (Churchich Park, Deer Hollow Park, Henry Doorly Zoo, Millard Highlands South, Roxbury Park, Rudy Novacek Memorial Garden) 5,154 feet of 5 trails (Unnamed, Big Papio South, MoPac Trail, Roxbury/Brookhaven Park, South Omaha Trail)  No Section 6(f) properties were identified within the ESA.	No farmland or center pivot systems are located within the ESA. All land within the ESA is classified as a Census Designated Urbanized Area and as such, would be exempt from the Farmland Protection Policy Act (FPPA)	Low income and minority populations potentially impacted  11 census tracts with low income and/or minority populations are located within the corridor.  Low Income Tracts: 31055010633, 31055002000, 31055002300, 31055002400, 31055002500, 31055003100, 31055003200, 31055003300, 31055007001, 31055007002  Minority Population Tracts: 31055002000, 31055002400, 31055002500, 31055003100, 31055003200, 31055003300, 31055003401	7 Category B receivers impacted  2 Category C receivers impacted	None.	Potential northern long-eared bat impacts if trees are removed.  Potential hazardous materials impacts depending on ground disturbance depth and location.  Potential Section 4(f) impacts with parks and trails.
	<b>Alternative 2</b>	0.33 ac NWI-mapped emergent wetland 6.35 ac NWI-mapped riverine wetland 13,718 linear feet NHD Waterways	Corridor is within the range of American ginseng, bald eagle, interior least tern, lake sturgeon, northern long-eared bat, pallid sturgeon, piping plover, river otter, sturgeon chub, and western prairie fringed orchid.  Suitable habitat for northern long-eared bat may be present in trees throughout the corridor.  Suitable habitat for river otter may be present along South Papillion Creek and Papillion Creek.  No suitable habitat is present for the other listed species.	62.09 ac floodplain 19.25 ac floodway 133.23 ac MUD Wellhead Protection Area 3 impaired waters (Big Papillion Creek [Recreation-Bacteria], Little Papillion Creek [Recreation-Bacteria], and West Papillion Creek [Aquatic Life - Fish Consumption Advisory]) 35 wells	24 NDEQ listed sites 45 EPA Facilities LST sites: 4 IWM sites: 1 SF sites: 1	No districts or structures impacted.	2.58 acres of 6 parks (Churchich Park, Deer Hollow Park, Henry Doorly Zoo, Millard Highlands South, Roxbury Park, Rudy Novacek Memorial Garden) 5,360 feet of 5 trails (Unnamed, Big Papio South, MoPac Trail, Roxbury/Brookhaven Park, South Omaha Trail)  No Section 6(f) properties were identified within the ESA.	No farmland or center pivot systems are located within the ESA. All land within the ESA is classified as a Census Designated Urbanized Area and as such, would be exempt from the Farmland Protection Policy Act (FPPA)	Low income and minority populations potentially impacted  11 census tracts with low income and/or minority populations are located within the corridor.  Low Income Tracts: 31055010633, 31055002000, 31055002300, 31055002400, 31055002500, 31055003100, 31055003200, 31055003300, 31055007001, 31055007002  Minority Population Tracts: 31055002000, 31055002400, 31055002500, 31055003100, 31055003200, 31055003300, 31055003401	39 Category B receivers impacted  2 Category C receivers impacted	None.	Potential northern long-eared bat impacts if trees are removed.  Potential hazardous materials impacts depending on ground disturbance depth and location.  Potential Section 4(f) impacts with parks and trails.
I-480	<b>Alternative 1</b>	No NWI Wetlands No NHD Waterways	American Ginseng, Bald Eagle, Northern Long-eared Bat  Suitable habitat for Northern Long-eared Bat may be present in trees throughout the corridor.  No suitable habitat is present for the other listed species.	No floodplains or floodways No impaired streams or waterbodies No federally constructed levees There is 1 groundwater well located within the ESA No wellhead protection areas are located within the ESA	2 NDEQ listed sites 23 EPA facilities AIR: 6 RCR: 1	No Historic Districts 1 Historic structure (Georgia Row House)	A portion, 0.03 acre, of Hanscom Park is located within the ESA.  No existing recreational trails are located within the ESA. Approximately 800 feet of a proposed trail at Vinton St, over I-480, are within the ESA.  No Section 6(f) properties were identified within the ESA.	No farmland or center pivot systems are located within the ESA. All land within the ESA is classified as a Census Designated Urbanized Area and as such, would be exempt from the Farmland Protection Policy Act (FPPA)	Five census tracts have low income and/or minority populations located within the ESA:  Low Income: 31055001600 31055004000 31055003900 31055003300 31055003800  Minority: 31055004000 31055003900 31055003300 31055003800	75 noise sensitive land uses, all NAC B, are located within the ESA.	None.	None.

**Table A.2 I-680 Existing Environmental Resources**

Corridor	Segment	Environmental Comparative Data										Environmental Summary
		Wetlands & WOUS	T&E Species	Floodplains & Water Resources	Hazardous Materials	Historical Resources	Section 4(f) & Section 6(f) Resources	Farmland	Environmental Justice	Noise-Sensitive Receivers	Other Resources of Concern	Comments
I-680 (I-80 through Dodge)	Alternative 1	1577.57 linear feet of NHD Waterways  1.64 acre of NWI-mapped riverine wetlands	Corridor is within the range of American Ginseng, Bald Eagle, Northern Long-eared Bat.  Suitable habitat for Northern Long-eared Bat may be present in trees throughout the corridor.  No suitable habitat is present for the other listed species.	11.83 acres floodplain  3.26 acres floodway  1 impaired water (Big Papillion Creek[4A-recreational use])  No federally constructed levees.  One groundwater well is located within the ESA.  No wellhead protection areas are located within the ESA.	No NDEQ sites  1 EPA facility	No districts or structures impacted	A portion, 0.36 acre, of Lamp Park is located within the ESA.  Approximately 745 feet of the Big Papio South is located within the ESA.  No Section 6(f) properties were identified within the ESA.	No farmland or center pivot systems are located within the ESA. All land within the ESA is classified as a Census Designated Urbanized Area and as such, would be exempt from the Farmland Protection Policy Act (FPPA)	No census tract with low income or minority populations located within the ESA.	7 noise sensitive land uses, all NAC B, are located within the ESA.	None.	None.
	Alternative 2	1577.57 linear feet of NHD Waterways  1.64 acre of NWI-mapped riverine wetlands	Corridor is within the range of American Ginseng, Bald Eagle, Northern Long-eared Bat.  Suitable habitat for Northern Long-eared Bat may be present in trees throughout the corridor.  No suitable habitat is present for the other listed species.	11.83 acres floodplain  3.26 acres floodway  1 impaired water (Big Papillion Creek[4A-recreational use])  No federally constructed levees.  One groundwater well is located within the ESA.  No wellhead protection areas are located within the ESA.	No NDEQ sites  1 EPA facility	No districts or structures impacted	A portion, 0.36 acre, of Lamp Park is located within the ESA.  Approximately 745 feet of the Big Papio South is located within the ESA.  No Section 6(f) properties were identified within the ESA.	No farmland or center pivot systems are located within the ESA. All land within the ESA is classified as a Census Designated Urbanized Area and as such, would be exempt from the Farmland Protection Policy Act (FPPA)	No census tract with low income or minority populations located within the ESA.	7 noise sensitive land uses, all NAC B, are located within the ESA.	None.	None.
I-680 (Dodge to Blair High)	Alternative 1	2174.64 linear feet NHD Waterways  0.75 acres NWI-mapped riverine wetlands	American Ginseng, Bald Eagle, Northern Long-eared Bat  Suitable habitat for Northern Long-eared Bat may be present in trees throughout the corridor.  No suitable habitat is present for the other listed species.	1.09 acres floodplain  1.09 floodway  1 Impaired water (Thomas Creek [5-aquatic life])  No federally constructed levees.  Two groundwater wells are located within the ESA.  No wellhead protection areas are located within the ESA.	5 NDEQ listed sites  3 EPA facilities	No districts or structures impacted	A portion, 0.22 acre, of Lee Valley Park is located within the ESA.  Approximately 850 feet of Military Rd Trail and 380 feet of a proposed trail along Thomas Creek are located within the ESA.  No Section 6(f) properties were identified within the ESA.	No farmland or center pivot systems are located within the ESA. All land within the ESA is classified as a Census Designated Urbanized Area and as such, would be exempt from the Farmland Protection Policy Act (FPPA)	Three census tracts with low income populations are located within the ESA:  31055007311 31055007434 31055007440  No census tract with minority populations are located within the ESA.	No noise sensitive land uses are located within the ESA.	None.	None.

**Table A.3 US-75 (Kennedy Freeway) and US-6 (West Dodge Road) Existing Environmental Resources**

Corridor	Segment	Environmental Comparative Data										Environmental Summary
		Wetlands & WOUS	T&E Species	Floodplains & Water Resources	Hazardous Materials	Historical Resources	Section 4(f) & Section 6(f) Resources	Farmland	Environmental Justice	Noise-Sensitive Receivers	Other Resources of Concern	Comments
US-75 (Kennedy Freeway)	Alternative 1	14,544.53 linear feet of NHD Waterways. 2.10 acres NWI-mapped emergent wetlands 0.42 acres NWI-mapped forested/shrub wetlands 4.91 acres NWI-mapped riverine wetlands	American Ginseng, Bald Eagle, Interior Least Tern, Lake Sturgeon, Northern Long-eared Bat, Pallid Sturgeon, Piping Plover, River Otter, Sturgeon Chub, Western Prairie Fringed Orchid  Suitable habitat for Northern Long-eared Bat may be present in trees throughout the corridor.  Suitable habitat for river otter may be present near Papillion Creek.  No suitable habitat is present for the other listed species.	132.54 acres Floodplain 95.58 acres Floodway 1 impaired water (Papillion Creek [5 - aquatic life and recreational use]) 7 levees (Big Papio LB-Big Elk Creek to Mud Creek; Big Papio LB-Betz Ditch to Capehart; Big Papio LB-Mud Creek to Betz Ditch; Big Papio LB-Mud Creek to Betz Ditch; Platte LB & Papillion RB & Missouri River RB; Papillion Creek LB; Big Papio RB-Willow Lakes to Whitted)  There are 5 groundwater wells located within the ESA.  No Wellhead protection areas located within the ESA.	20 NDEQ Sites 44 EPA Sites Brownfields: 2 AIR: 16 RCR: 7	No Historic Districts  No Historic structures	A portion of two parks are located within the ESA: Tregaron Golf Course (approximately 0.04 acre) and Highland Park (approximately 0.04 acre).  Approximately 7588 feet of the Keystone Trail are located within the ESA.  No Section 6(f) properties were identified within the ESA.	Prime farmland, unique farmland, or farmland of statewide importance are located within the ESA  Prime Farmland 84.0 acres  Prime Farmland if Drained 267.5 acres  Farmland of Statewide Importance 140.9 acres	Nine census tracts have either low income or minority populations located within the ESA:  Low Income 31153010305 31055003200 31055002700 31055002800 31055002900 31153010108 31153010204  Minority 31153010305 31153010302 31153010204 31055003200 31055002700 31055002800 31055002900 31153010108 31153010107	62 noise sensitive land uses, all NAC B, are located within the ESA.	None.	None.
US-6 (West Dodge Road)	Alternative 1	0.30 ac NWI-mapped freshwater forested/shrub wetland 3.74 ac NWI-mapped riverine wetland 8,003 linear feet NHD Waterways	Corridor is within the range of American ginseng, bald eagle, interior least tern, lake sturgeon, northern long-eared bat, pallid sturgeon, piping plover, river otter, and sturgeon chub.  Suitable habitat for northern long-eared bat may be present in trees throughout the corridor.  Suitable habitat for river otter may be present near Lawrence Youngman Lake.  No suitable habitat is present for the other listed species.	4.74 ac floodplain 2.64 ac floodway 24.44 ac Douglas County SID #258 - Carat Homes Wellhead Protection Area 1 impaired water (West Papillion Creek [Aquatic Life - Impaired Aquatic Community]) 7 wells	13 NDEQ listed sites 29 EPA Facilities LST sites: 3 IWM sites: 1  There are no SF sites in the ESA.	1 district (Father Flanagan's Boys' Home)  1 historic structure (Lincoln Highway - Omaha to Elkhorn) impacted	2.91 ac of 2 parks (Lawrence Youngman Lake Park and Northwest Park)  4,369 feet of 7 trails (Unnamed, 144th Street North, 144th Street South, 180th Street South, West Papio Connector, West Papio North, West Papio South)  No Section 6(f) properties were identified within the ESA.	No farmland or center pivot systems are located within the ESA. All land within the ESA is classified as a Census Designated Urbanized Area and as such, would be exempt from the Farmland Protection Policy Act (FPPA)	No census tracts with low income or minority populations are located in the corridor.	1 Category C receiver impacted	None.	Potential northern long-eared bat impacts if trees are removed.  Potential hazardous materials impacts depending on ground disturbance depth and location.  Potential Section 4(f) impacts with parks and trails.
	Alternative 2	0.30 ac NWI-mapped freshwater forested/shrub wetland 3.74 ac NWI-mapped riverine wetland 8,003 linear feet NHD Waterways	Corridor is within the range of American ginseng, bald eagle, interior least tern, lake sturgeon, northern long-eared bat, pallid sturgeon, piping plover, river otter, and sturgeon chub.  Suitable habitat for northern long-eared bat may be present in trees throughout the corridor.  Suitable habitat for river otter may be present near Lawrence Youngman Lake.  No suitable habitat is present for the other listed species.	4.74 ac floodplain 2.64 ac floodway 24.44 ac Douglas County SID #258 - Carat Homes Wellhead Protection Area 1 impaired water (West Papillion Creek [Aquatic Life - Impaired Aquatic Community]) 7 wells	12 NDEQ listed sites 29 EPA Facilities LST sites: 3 IWM sites: 1  There are no SF sites in the ESA.	1 district (Father Flanagan's Boys' Home)  1 historic structure (Lincoln Highway - Omaha to Elkhorn) impacted	2.91 ac of 2 parks (Lawrence Youngman Lake Park and Northwest Park)  4,369 feet of 7 trails (Unnamed, 144th Street North, 144th Street South, 180th Street South, West Papio Connector, West Papio North, West Papio South)  No Section 6(f) properties were identified within the ESA.	No farmland or center pivot systems are located within the ESA. All land within the ESA is classified as a Census Designated Urbanized Area and as such, would be exempt from the Farmland Protection Policy Act (FPPA)	No census tracts with low income or minority populations are located in the ESA.	1 Category C receiver impacted	None.	Potential northern long-eared bat impacts if trees are removed.  Potential hazardous materials impacts depending on ground disturbance depth and location.  Potential Section 4(f) impacts with park and trails and trails.
	Alternative 3	0.30 ac NWI-mapped Freshwater forested/shrub wetland 3.72 ac NWI-mapped riverine wetland 7,962 linear feet NHD Waterways	Corridor is within the range of American ginseng, bald eagle, interior least tern, lake sturgeon, northern long-eared bat, pallid sturgeon, piping plover, river otter, sturgeon chub.  Suitable habitat for northern long-eared bat may be present in trees throughout the corridor.  Suitable habitat for river otter may be present near Lawrence Youngman Lake.  No suitable habitat is present for the other listed species.	4.75 ac floodplain 2.57 ac floodway 24.44 ac Douglas County SID #258 - Carat Homes Wellhead Protection Area 1 impaired water (West Papillion Creek [Aquatic Life - Impaired Aquatic Community]) 7 wells	13 NDEQ listed sites 29 EPA Facilities LST sites: 3 IWM sites: 1  There are no SF sites in the ESA.	1 district (Father Flanagan's Boys' Home)  1 historic structure (Lincoln Highway - Omaha to Elkhorn) impacted	2.91 ac of 2 parks (Lawrence Youngman Lake Park and Northwest Park)  4,369 feet of 7 trails (Unnamed, 144th Street North, 144th Street South, 180th Street South, West Papio Connector, West Papio North, West Papio South)  No Section 6(f) properties were identified within the ESA.	No farmland or center pivot systems are located within the ESA. All land within the ESA is classified as a Census Designated Urbanized Area and as such, would be exempt from the Farmland Protection Policy Act (FPPA)	No census tracts with low income or minority populations are located in the corridor.	1 Category C receiver impacted	None.	Potential northern long-eared bat impacts if trees are removed.  Potential hazardous materials impacts depending on ground disturbance depth and location.  Potential Section 4(f) impacts with parks and trails.



## Appendix B - I-80

### *Figures Included in Appendix B:*

- I-80 Recommended Concept: Figures 1–16
- I-80 Typical Section: Figure 17

A DDI at the N-31 interchange and the widening of N-31 to the north of I-80 would not be needed if: (1) a new interchange in the vicinity of 186th Street were to be constructed and (2) capacity improvements were made to the east/west arterial network in the Gretna area including Capehart Road and Schram Road.

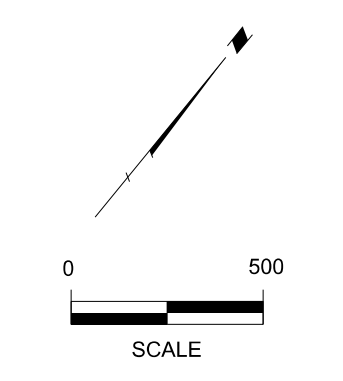

31

**Legend**

- Proposed Pavement
- Existing Bridge
- Proposed Bridge or Widening
- Programmed / Proposed Non-Freeway Improvements
- Dividing Barriers
- Existing Lane Designation / Flow
- Proposed Lane Designation
- XX Road Closure / Removal

Sources:  
 1. Aerial Photography - MAPA 2016  
 2. Concept - HDR 2017

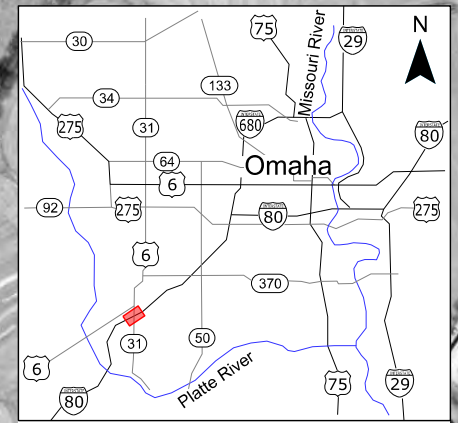

Key Map  
N.T.S.

**PRELIMINARY PLAN**  
 NOT FINAL - SUBJECT TO CHANGE

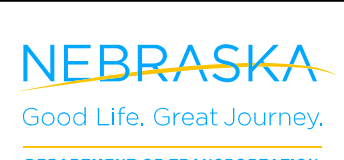

I-80 Recommended Concept  
 Metro Area Travel Improvement Study  
 Douglas and Sarpy County, Nebraska

March 2019  
 Figure 1



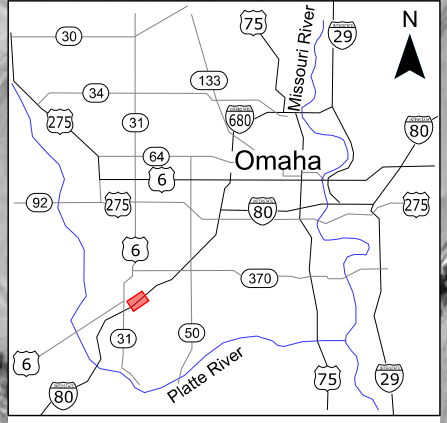
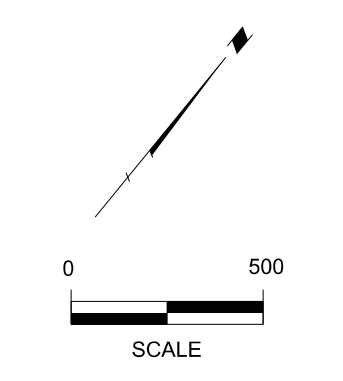

Sources:  
 1. Aerial Photography - MAPA 2016  
 2. Concept - HDR 2017

**PRELIMINARY PLAN**  
 NOT FINAL - SUBJECT TO CHANGE



I-80 Recommended Concept  
 Metro Area Travel Improvement Study  
 Douglas and Sarpy County, Nebraska

March 2019  
 Figure 2



Potential Interchange Location  
Evaluated by others - not part of MTIS

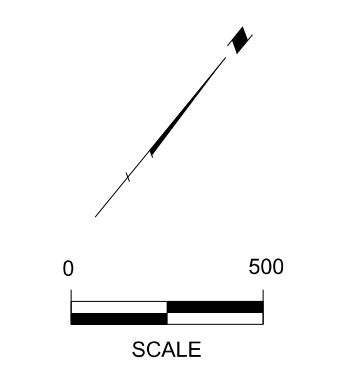

**Legend**

- Proposed Pavement
- Existing Bridge
- Proposed Bridge or Widening
- Programmed / Proposed Non-Freeway Improvements
- Dividing Barriers
- 3 Existing Lane Designation / Flow
- E Proposed Lane Designation
- XX Road Closure / Removal

Sources:  
1. Aerial Photography - MAPA 2016  
2. Concept - HDR 2017

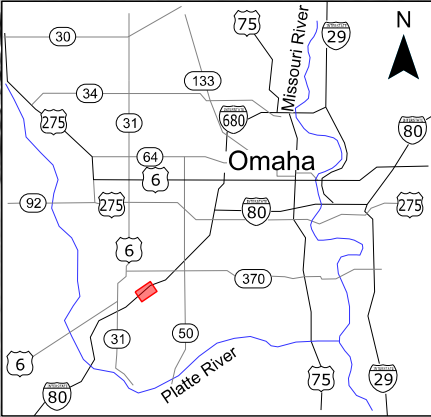

**Key Map**  
N.T.S.

**PRELIMINARY PLAN**  
NOT FINAL - SUBJECT TO CHANGE



**I-80** I-80 Recommended Concept  
Metro Area Travel Improvement Study  
Douglas and Sarpy County, Nebraska

March 2019  
Figure 3

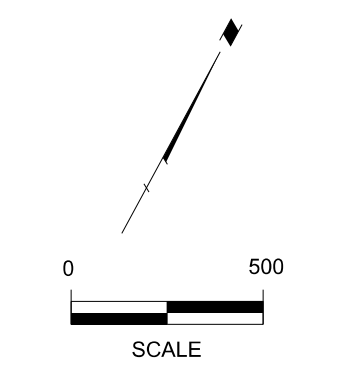

- Legend**
- Proposed Pavement
  - Existing Bridge
  - Proposed Bridge or Widening
  - Programmed / Proposed Non-Freeway Improvements
  - Dividing Barriers
  - Existing Lane Designation / Flow
  - Proposed Lane Designation
  - XX** Road Closure / Removal

Sources:  
 1. Aerial Photography - MAPA 2016  
 2. Concept - HDR 2017

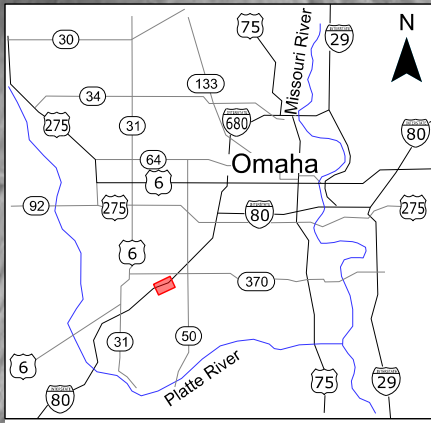

**Key Map**  
N.T.S.

**PRELIMINARY PLAN**  
 NOT FINAL - SUBJECT TO CHANGE



**I-80** I-80 Recommended Concept  
 Metro Area Travel Improvement Study  
 Douglas and Sarpy County, Nebraska

March 2019  
 Figure 4

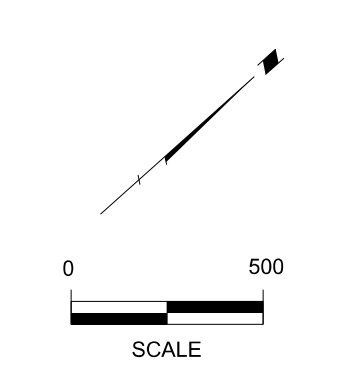
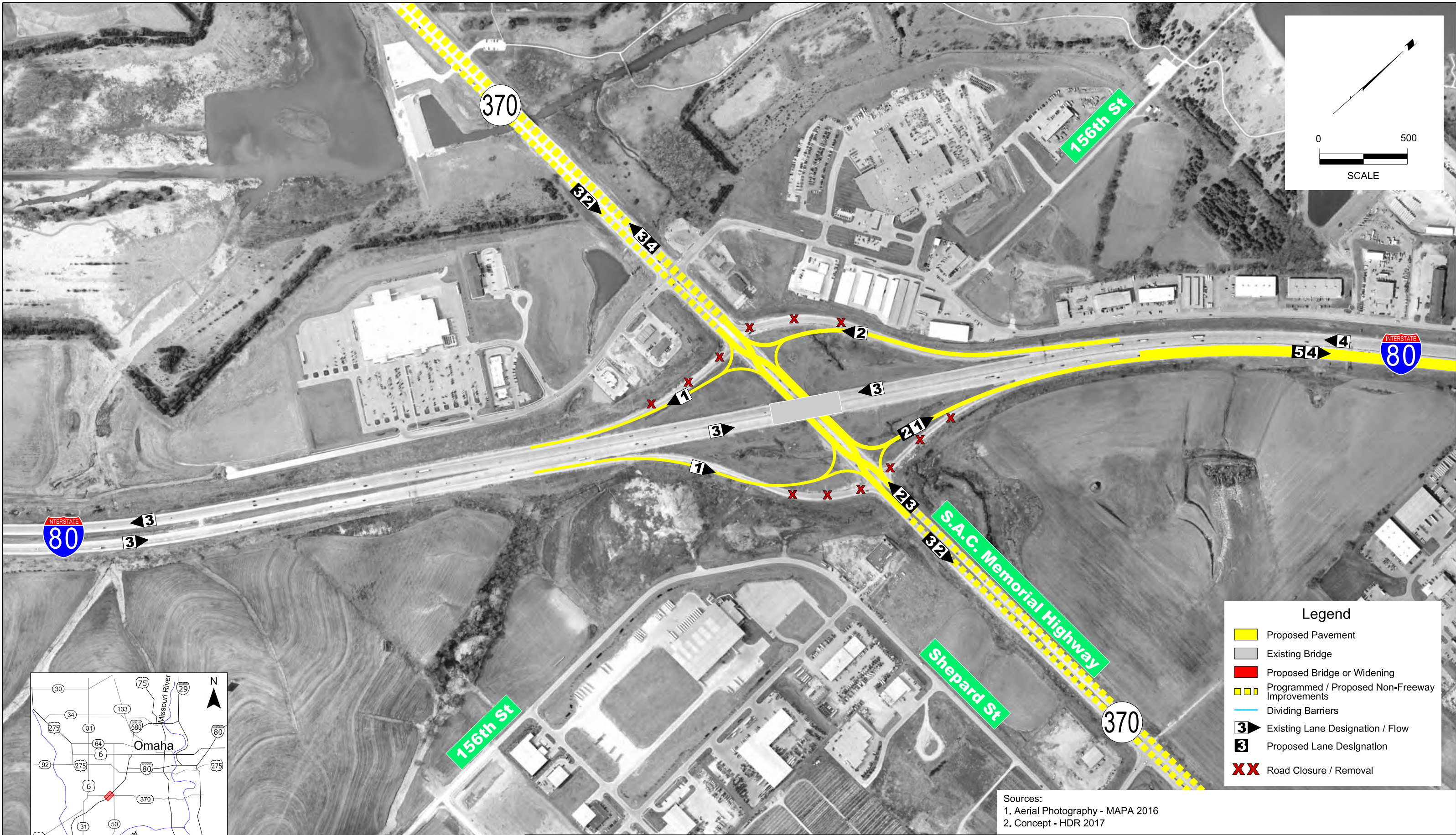

Legend	
	Proposed Pavement
	Existing Bridge
	Proposed Bridge or Widening
	Programmed / Proposed Non-Freeway Improvements
	Dividing Barriers
	Existing Lane Designation / Flow
	Proposed Lane Designation
	Road Closure / Removal

Sources:  
 1. Aerial Photography - MAPA 2016  
 2. Concept - HDR 2017

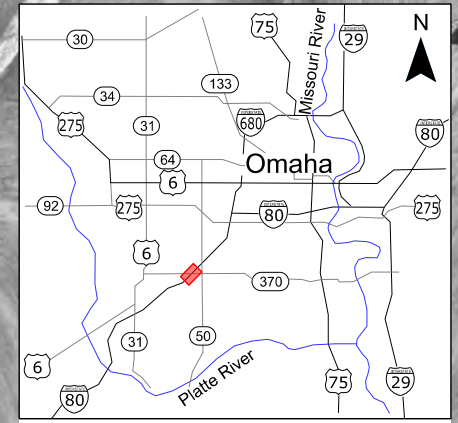

Key Map  
 N.T.S.

**PRELIMINARY PLAN**  
 NOT FINAL - SUBJECT TO CHANGE



I-80 Recommended Concept  
 Metro Area Travel Improvement Study  
 Douglas and Sarpy County, Nebraska

March 2019  
 Figure 5

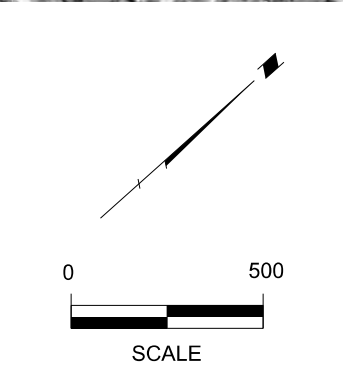
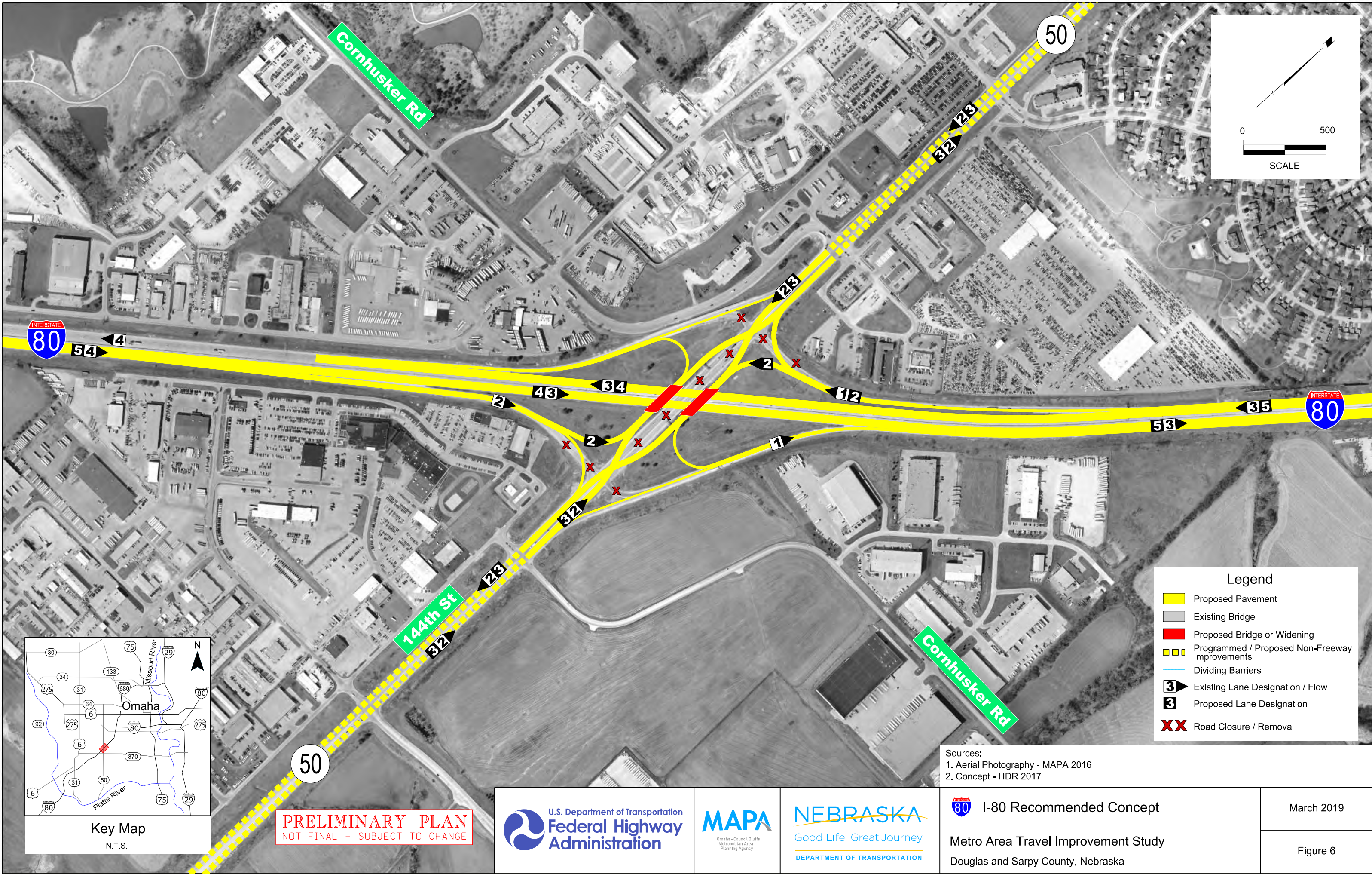

- Legend**
- Proposed Pavement
  - Existing Bridge
  - Proposed Bridge or Widening
  - Programmed / Proposed Non-Freeway Improvements
  - Dividing Barriers
  - Existing Lane Designation / Flow
  - Proposed Lane Designation
  - XX Road Closure / Removal

Sources:  
 1. Aerial Photography - MAPA 2016  
 2. Concept - HDR 2017

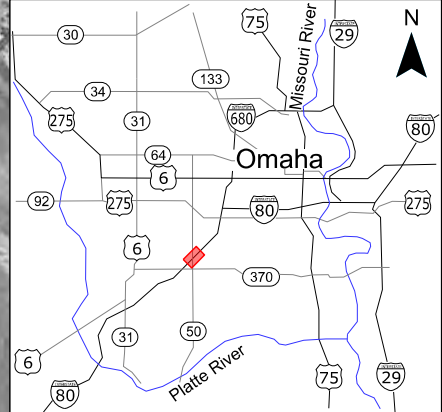

**Key Map**  
N.T.S.

**PRELIMINARY PLAN**  
 NOT FINAL - SUBJECT TO CHANGE



**I-80 Recommended Concept**  
 Metro Area Travel Improvement Study  
 Douglas and Sarpy County, Nebraska

March 2019  
 Figure 6

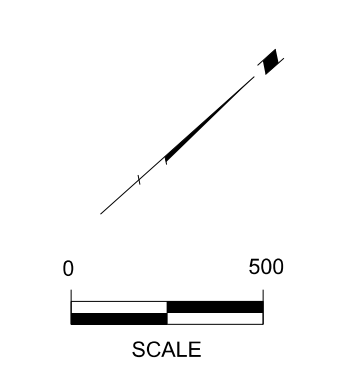
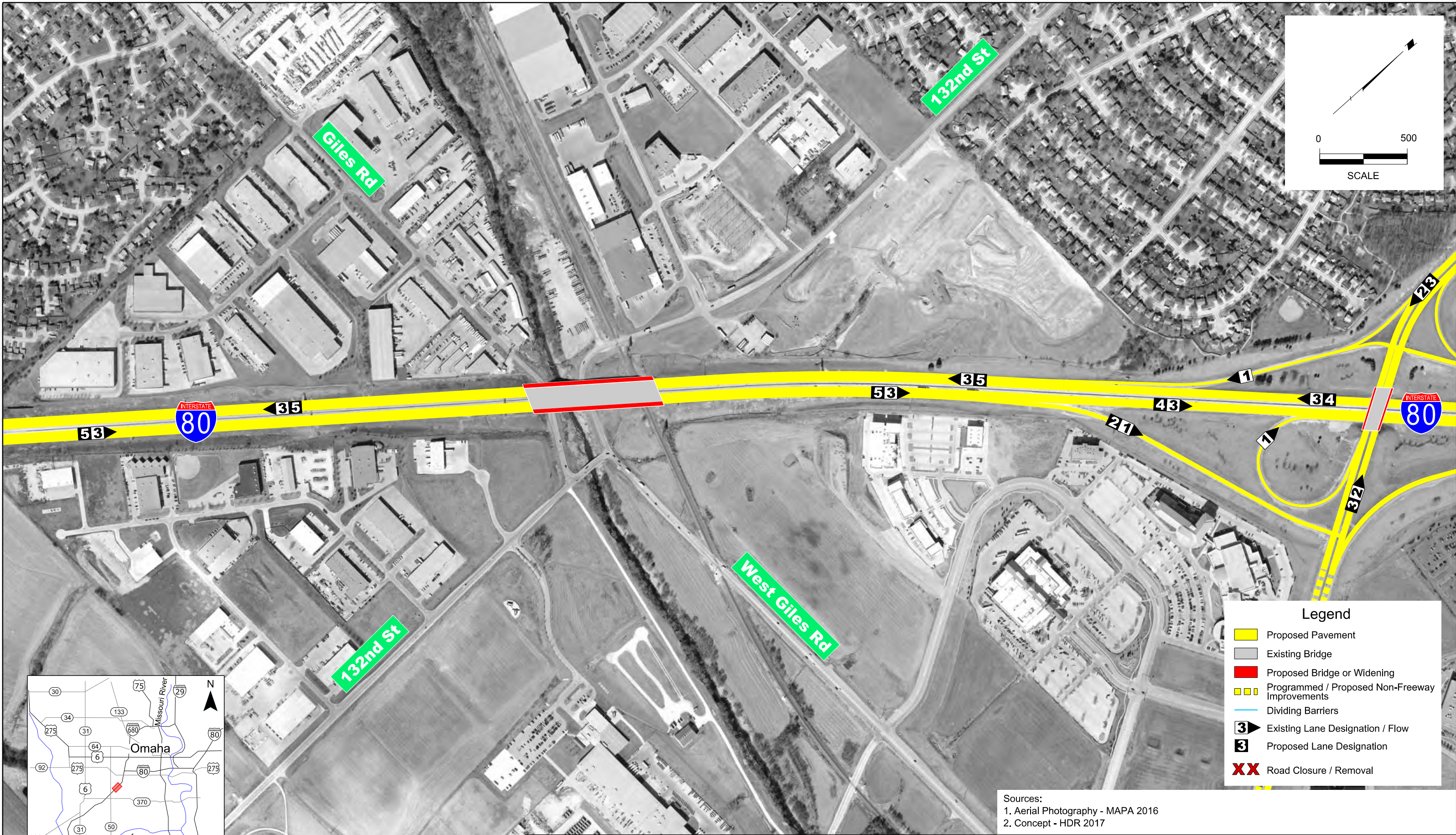

- Legend**
- Proposed Pavement
  - Existing Bridge
  - Proposed Bridge or Widening
  - Programmed / Proposed Non-Freeway Improvements
  - Dividing Barriers
  - Existing Lane Designation / Flow
  - Proposed Lane Designation
  - XX Road Closure / Removal

Sources:  
 1. Aerial Photography - MAPA 2016  
 2. Concept - HDR 2017

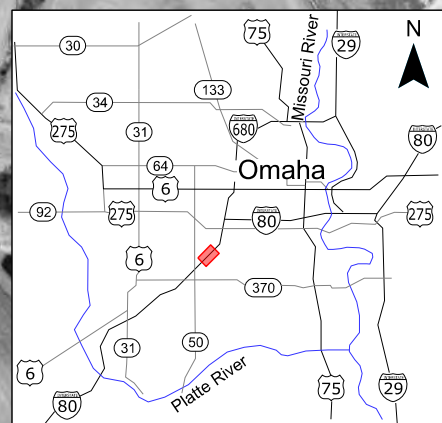

**Key Map**  
N.T.S.

**PRELIMINARY PLAN**  
 NOT FINAL - SUBJECT TO CHANGE



**I-80 Recommended Concept**  
 Metro Area Travel Improvement Study  
 Douglas and Sarpy County, Nebraska

March 2019

Figure 7

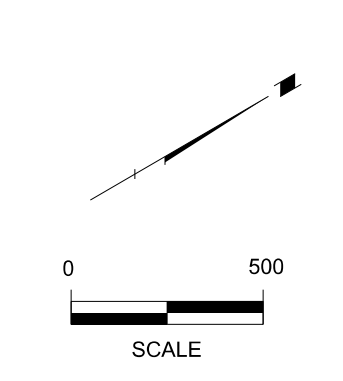
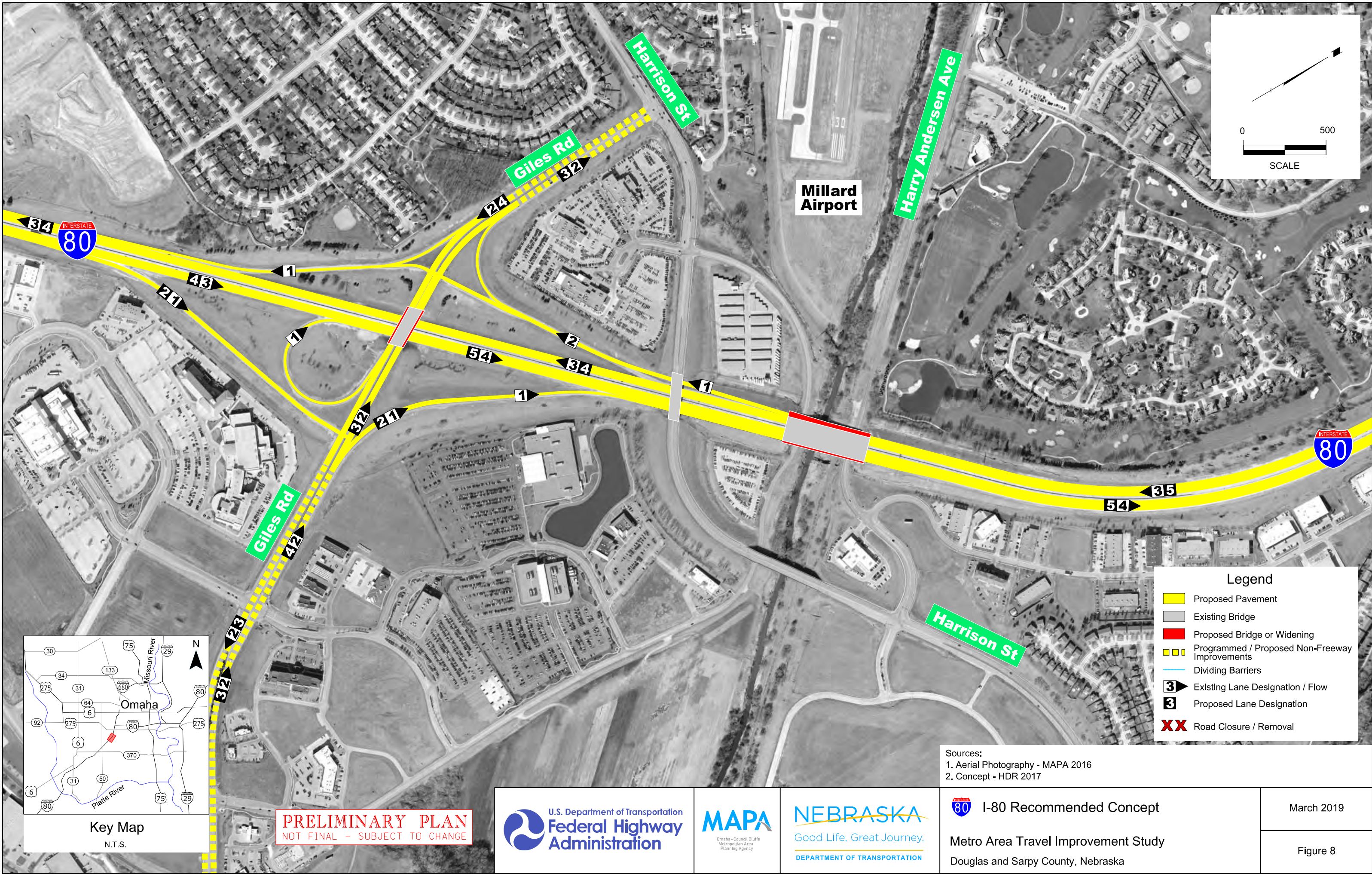

Legend	
	Proposed Pavement
	Existing Bridge
	Proposed Bridge or Widening
	Programmed / Proposed Non-Freeway Improvements
	Dividing Barriers
	Existing Lane Designation / Flow
	Proposed Lane Designation
	Road Closure / Removal

Sources:  
 1. Aerial Photography - MAPA 2016  
 2. Concept - HDR 2017

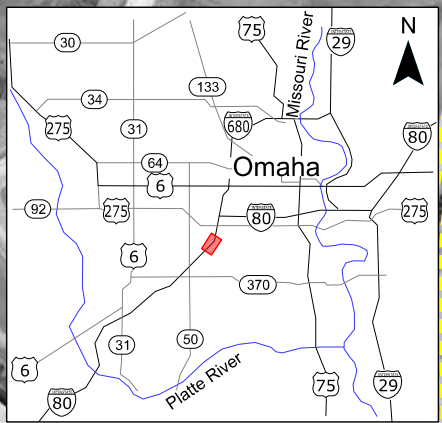

Key Map  
N.T.S.

**PRELIMINARY PLAN**  
 NOT FINAL - SUBJECT TO CHANGE



I-80 Recommended Concept  
 Metro Area Travel Improvement Study  
 Douglas and Sarpy County, Nebraska

March 2019  
 Figure 8

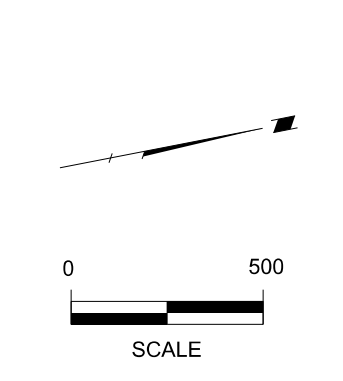
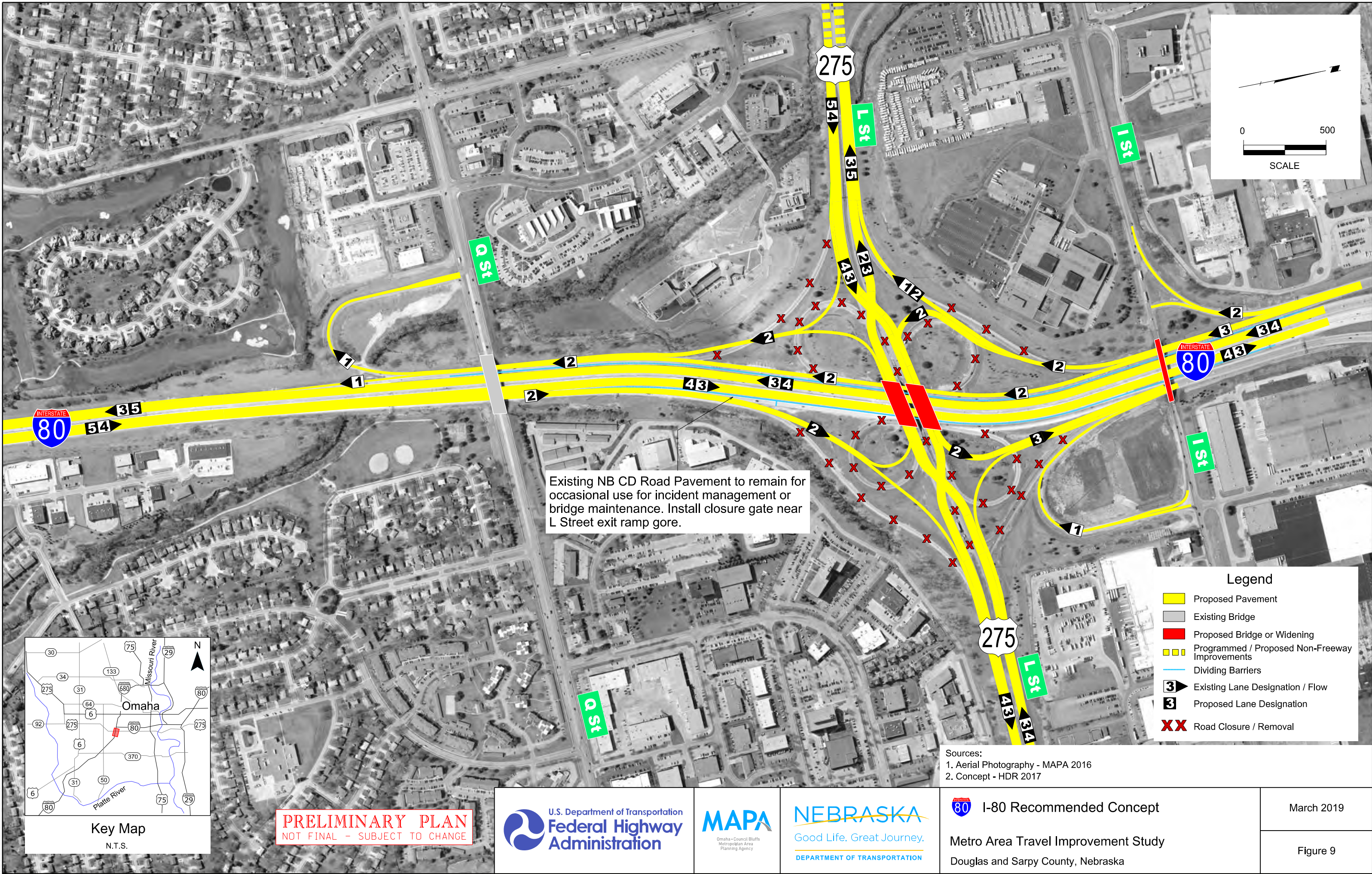

Existing NB CD Road Pavement to remain for occasional use for incident management or bridge maintenance. Install closure gate near L Street exit ramp gore.

- Legend**
- Proposed Pavement
  - Existing Bridge
  - Proposed Bridge or Widening
  - Programmed / Proposed Non-Freeway Improvements
  - Dividing Barriers
  - Existing Lane Designation / Flow
  - Proposed Lane Designation
  - XX Road Closure / Removal

Sources:  
 1. Aerial Photography - MAPA 2016  
 2. Concept - HDR 2017

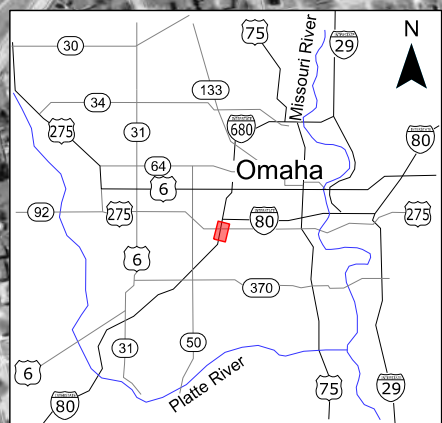

Key Map  
N.T.S.

**PRELIMINARY PLAN**  
 NOT FINAL - SUBJECT TO CHANGE



**I-80 Recommended Concept**  
 Metro Area Travel Improvement Study  
 Douglas and Sarpy County, Nebraska

March 2019  
 Figure 9



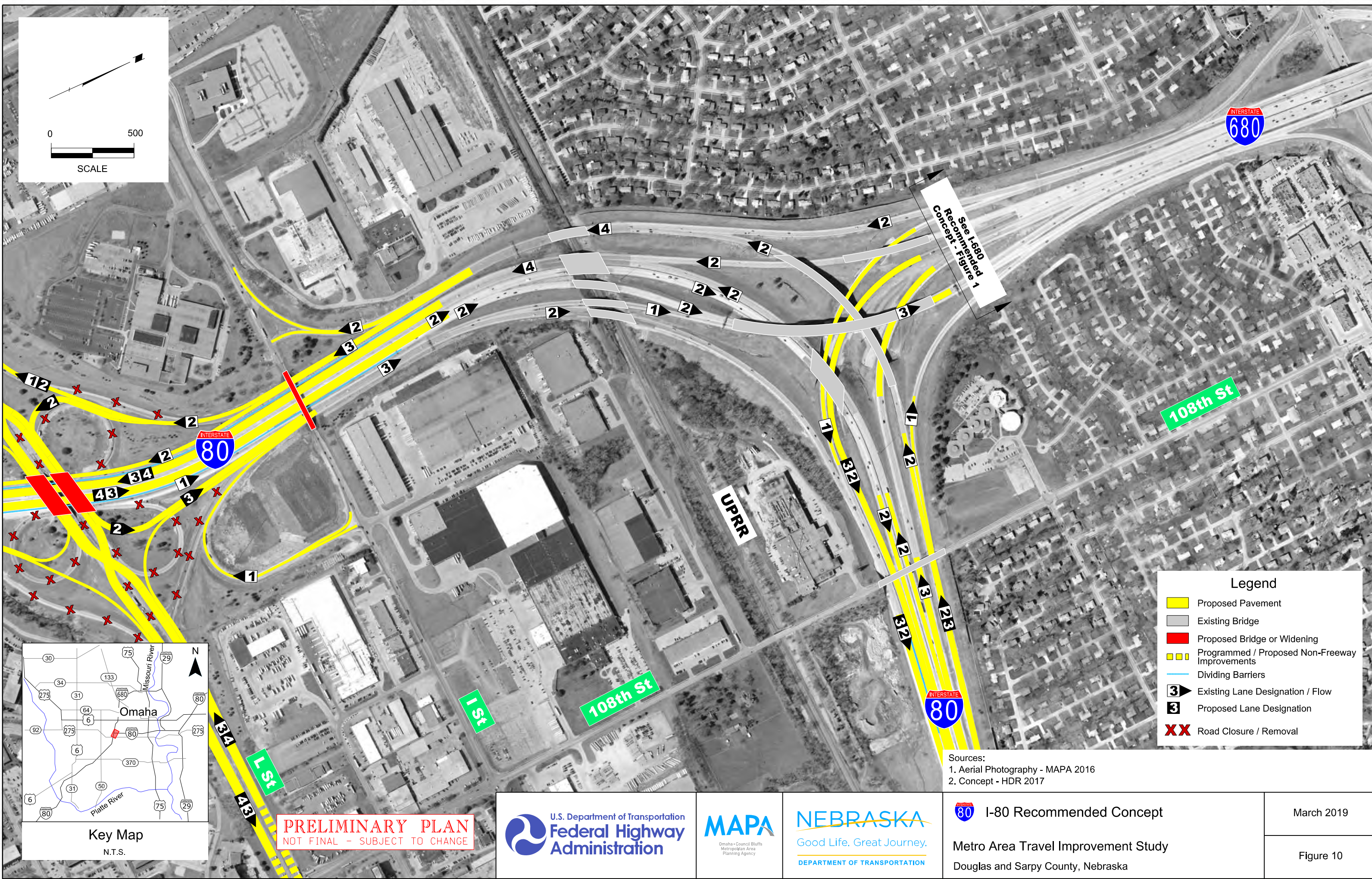
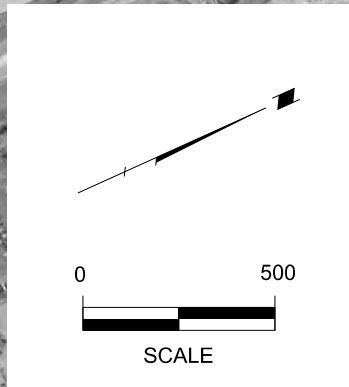

See I-680  
Recommended  
Concept - Figure 1

108th St

UPRR

1st St

108th St

L St

43

**Legend**

- Proposed Pavement
- Existing Bridge
- Proposed Bridge or Widening
- Programmed / Proposed Non-Freeway Improvements
- Dividing Barriers
- Existing Lane Designation / Flow
- Proposed Lane Designation
- Road Closure / Removal

Sources:  
1. Aerial Photography - MAPA 2016  
2. Concept - HDR 2017

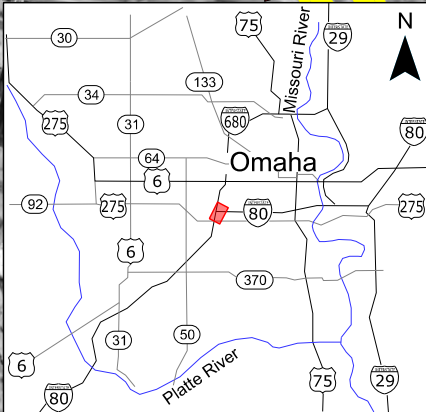

**PRELIMINARY PLAN**  
NOT FINAL - SUBJECT TO CHANGE



I-80 Recommended Concept  
Metro Area Travel Improvement Study  
Douglas and Sarpy County, Nebraska

March 2019  
Figure 10

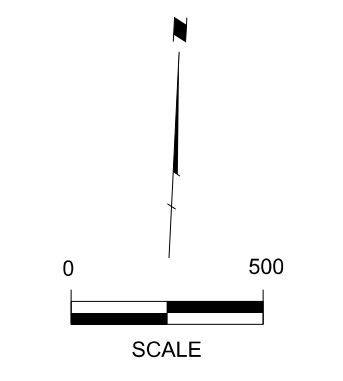
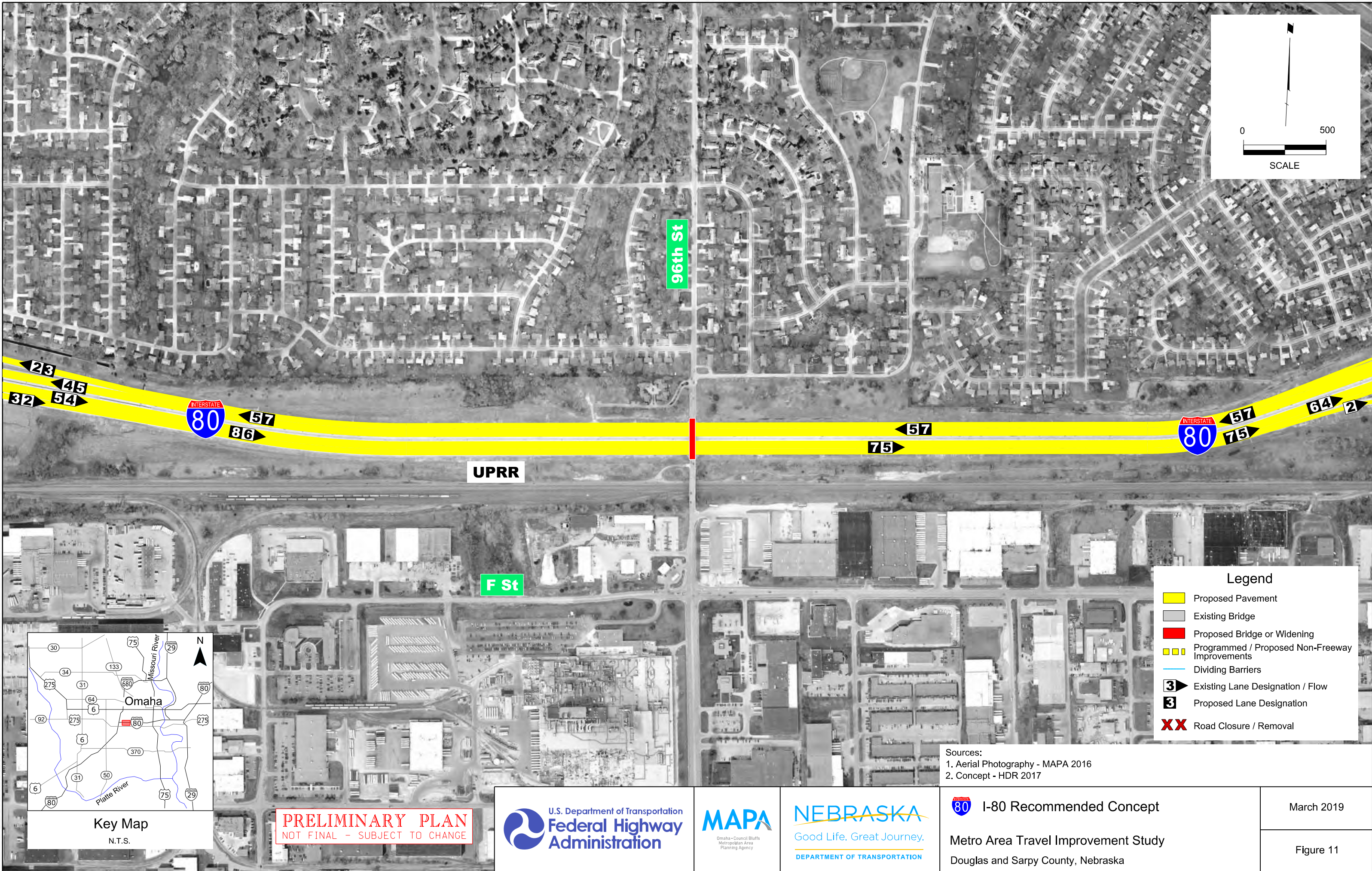

**Legend**

- Proposed Pavement
- Existing Bridge
- Proposed Bridge or Widening
- Programmed / Proposed Non-Freeway Improvements
- Dividing Barriers
- Existing Lane Designation / Flow
- Proposed Lane Designation
- XX Road Closure / Removal

Sources:  
 1. Aerial Photography - MAPA 2016  
 2. Concept - HDR 2017

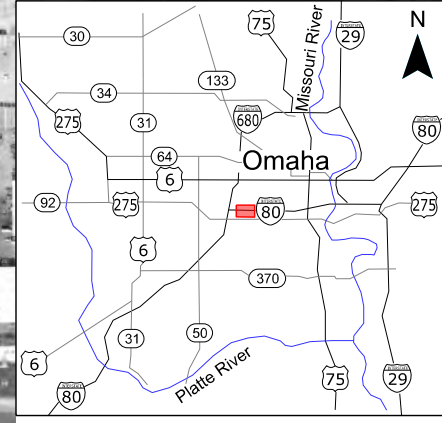

Key Map  
N.T.S.

**PRELIMINARY PLAN**  
 NOT FINAL - SUBJECT TO CHANGE



**I-80** I-80 Recommended Concept  
 Metro Area Travel Improvement Study  
 Douglas and Sarpy County, Nebraska

March 2019  
 Figure 11

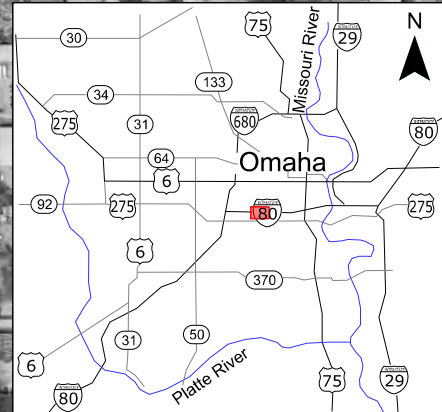
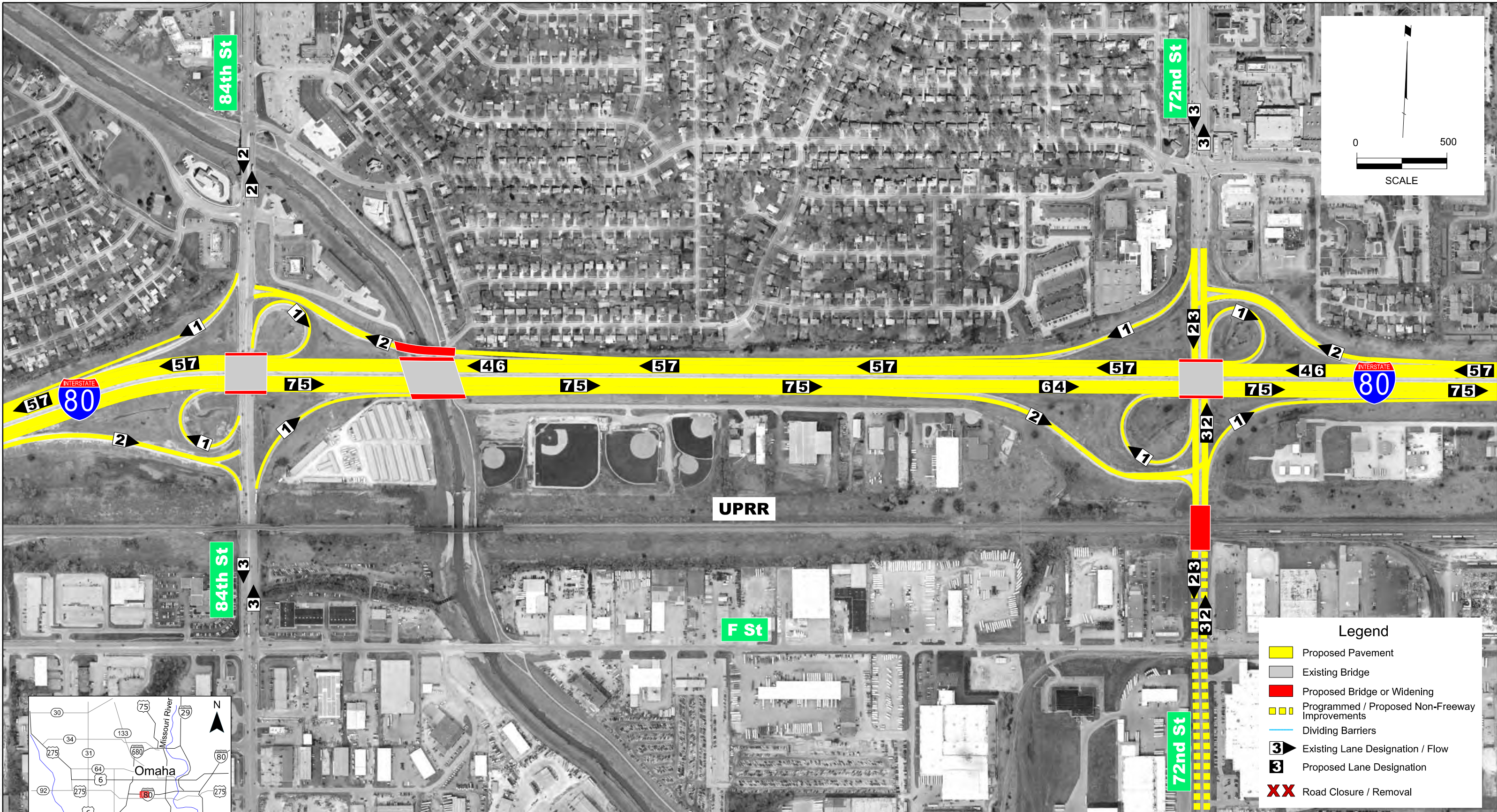

Key Map  
N.T.S.

**PRELIMINARY PLAN**  
NOT FINAL - SUBJECT TO CHANGE



**I-80** I-80 Recommended Concept  
Metro Area Travel Improvement Study  
Douglas and Sarpy County, Nebraska

March 2019

Figure 12

Sources:  
1. Aerial Photography - MAPA 2016  
2. Concept - HDR 2017

- Legend**
- Proposed Pavement
  - Existing Bridge
  - Proposed Bridge or Widening
  - Programmed / Proposed Non-Freeway Improvements
  - Dividing Barriers
  - 3 Existing Lane Designation / Flow
  - 3 Proposed Lane Designation
  - XX Road Closure / Removal

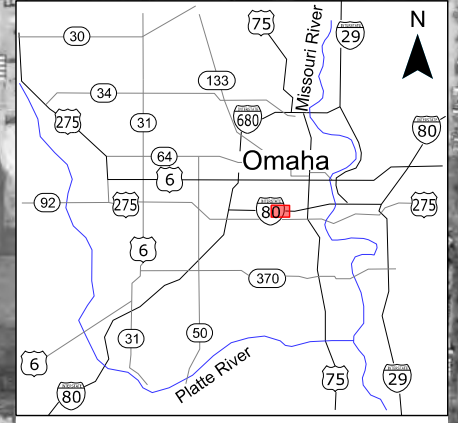
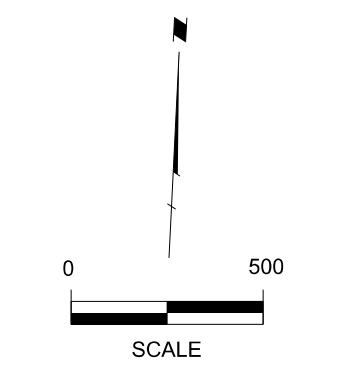
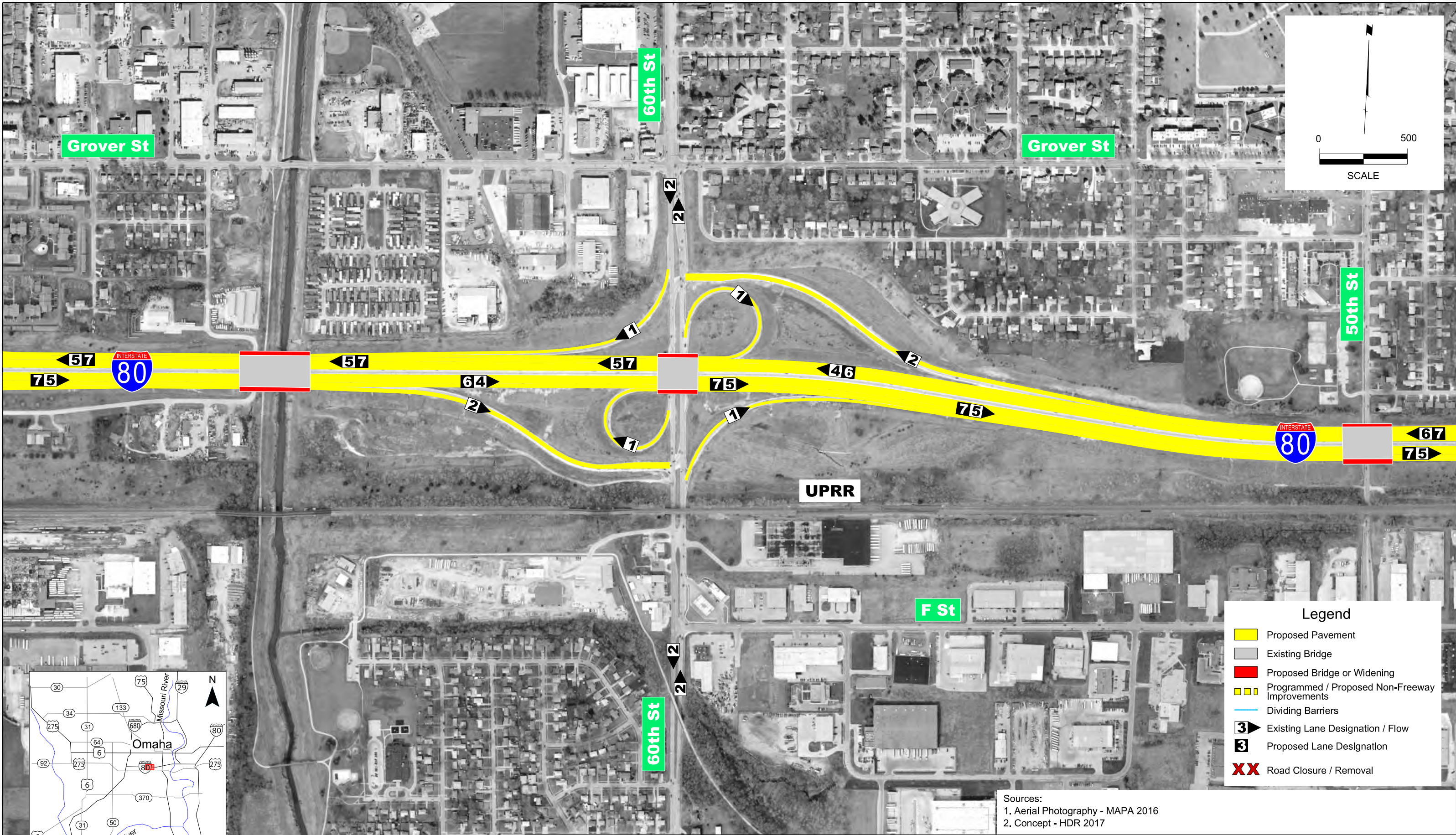

Legend	
	Proposed Pavement
	Existing Bridge
	Proposed Bridge or Widening
	Programmed / Proposed Non-Freeway Improvements
	Dividing Barriers
	Existing Lane Designation / Flow
	Proposed Lane Designation
	Road Closure / Removal

Sources:  
 1. Aerial Photography - MAPA 2016  
 2. Concept - HDR 2017

**PRELIMINARY PLAN**  
 NOT FINAL - SUBJECT TO CHANGE



I-80 Recommended Concept  
 Metro Area Travel Improvement Study  
 Douglas and Sarpy County, Nebraska

March 2019  
 Figure 13

Key Map  
 N.T.S.

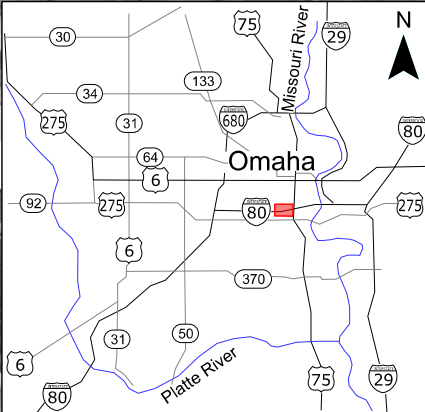
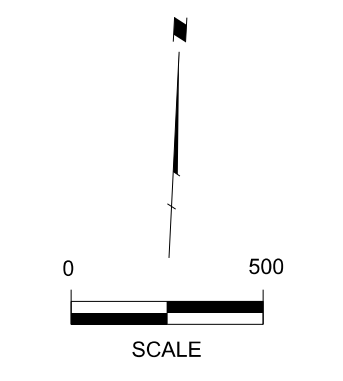

**Legend**

- Proposed Pavement
- Existing Bridge
- Proposed Bridge or Widening
- Programmed / Proposed Non-Freeway Improvements
- Dividing Barriers
- Existing Lane Designation / Flow
- Proposed Lane Designation
- XX Road Closure / Removal

Sources:  
 1. Aerial Photography - MAPA 2016  
 2. Concept - HDR 2017

Key Map  
N.T.S.

**PRELIMINARY PLAN**  
 NOT FINAL - SUBJECT TO CHANGE



**I-80 Recommended Concept**  
 Metro Area Travel Improvement Study  
 Douglas and Sarpy County, Nebraska

March 2019  
 Figure 14

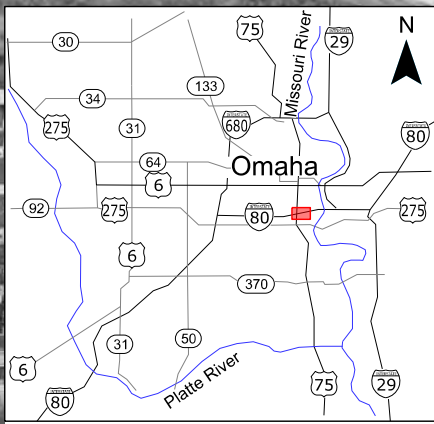
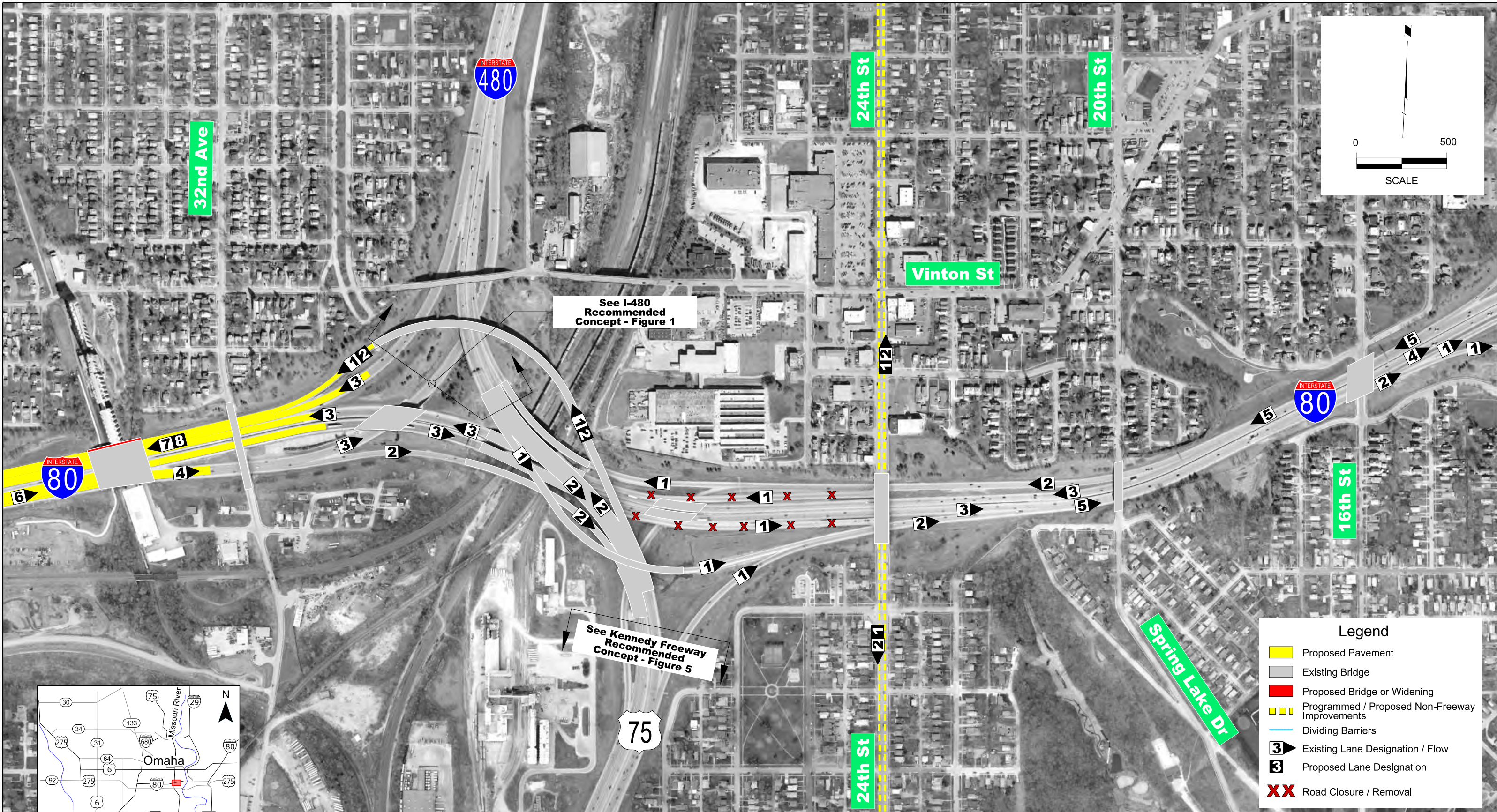

Key Map  
N.T.S.

**PRELIMINARY PLAN**  
NOT FINAL - SUBJECT TO CHANGE



**I-80 Recommended Concept**  
Metro Area Travel Improvement Study  
Douglas and Sarpy County, Nebraska

March 2019

Figure 15

Legend	
	Proposed Pavement
	Existing Bridge
	Proposed Bridge or Widening
	Programmed / Proposed Non-Freeway Improvements
	Dividing Barriers
	Existing Lane Designation / Flow
	Proposed Lane Designation
	Road Closure / Removal

Sources:  
1. Aerial Photography - MAPA 2016  
2. Concept - HDR 2017

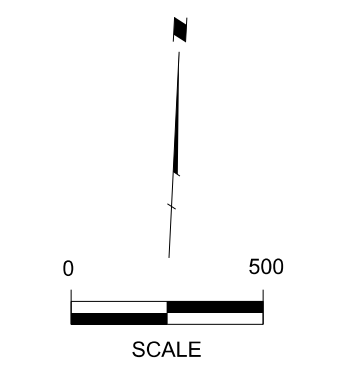

**Legend**

- Proposed Pavement
- Existing Bridge
- Proposed Bridge or Widening
- Programmed / Proposed Non-Freeway Improvements
- Dividing Barriers
- Existing Lane Designation / Flow
- Proposed Lane Designation
- XX Road Closure / Removal

Sources:  
 1. Aerial Photography - MAPA 2016  
 2. Concept - HDR 2017

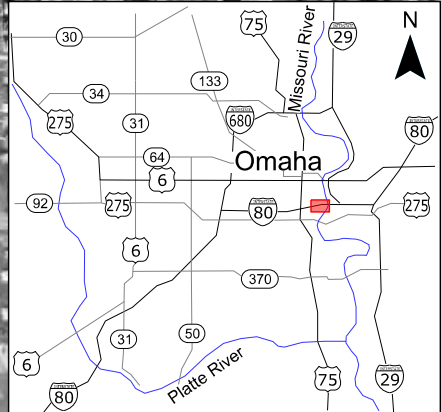

**Key Map**  
N.T.S.

**PRELIMINARY PLAN**  
 NOT FINAL - SUBJECT TO CHANGE



**I-80 Recommended Concept**  
 Metro Area Travel Improvement Study  
 Douglas and Sarpy County, Nebraska

March 2019  
 Figure 16

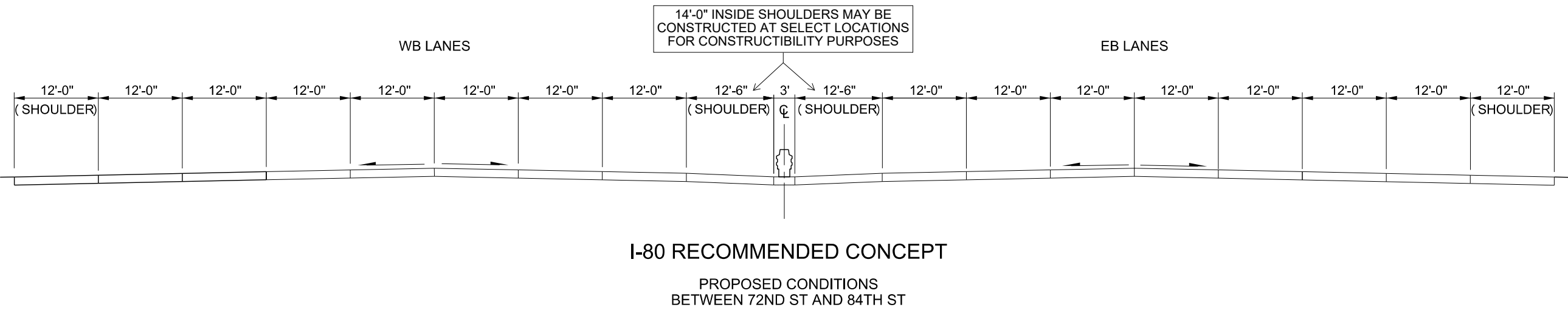
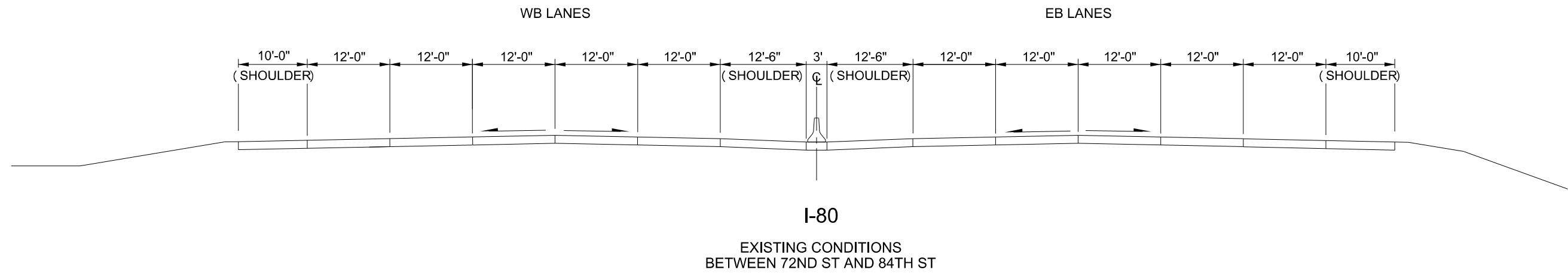

**PRELIMINARY PLAN**  
NOT FINAL - SUBJECT TO CHANGE



**TYPICAL SECTIONS**  
Between 84TH ST AND 72ND ST  
Metro Area Travel Improvement Study  
Douglas and Sarpy County, Nebraska

March 2019

Figure 17





## Appendix C - I-480

### *Figures Included in Appendix C:*

- I-480 Recommended Concept: Figures 1–3
- I-480 Typical Section: Figure 4

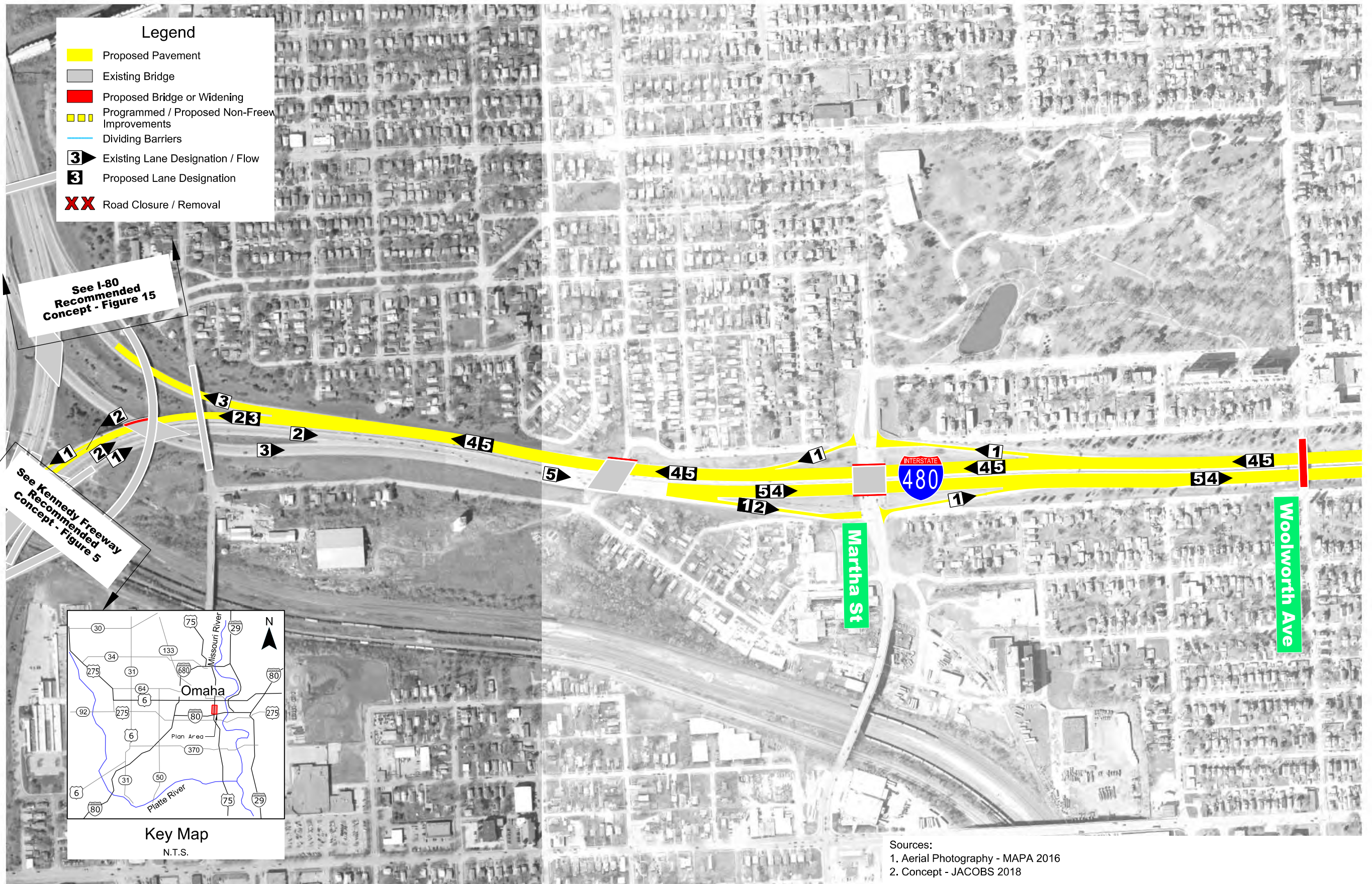

**Legend**

- Proposed Pavement
- Existing Bridge
- Proposed Bridge or Widening
- Programmed / Proposed Non-Freeway Improvements
- Dividing Barriers
- 3 Existing Lane Designation / Flow
- 3 Proposed Lane Designation
- XX Road Closure / Removal

See I-80 Recommended Concept - Figure 15

See Kennedy Freeway Recommended Concept - Figure 5

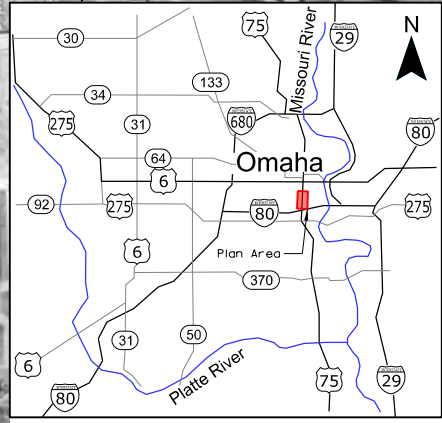

**Key Map**  
N.T.S.

Sources:  
1. Aerial Photography - MAPA 2016  
2. Concept - JACOBS 2018

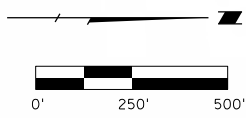

**PRELIMINARY PLAN**  
NOT FINAL - SUBJECT TO CHANGE



**I-480** I-480 Recommended Concept  
Metro Area Travel Improvement Study  
Douglas and Sarpy County, Nebraska

March 2019  
Figure 1

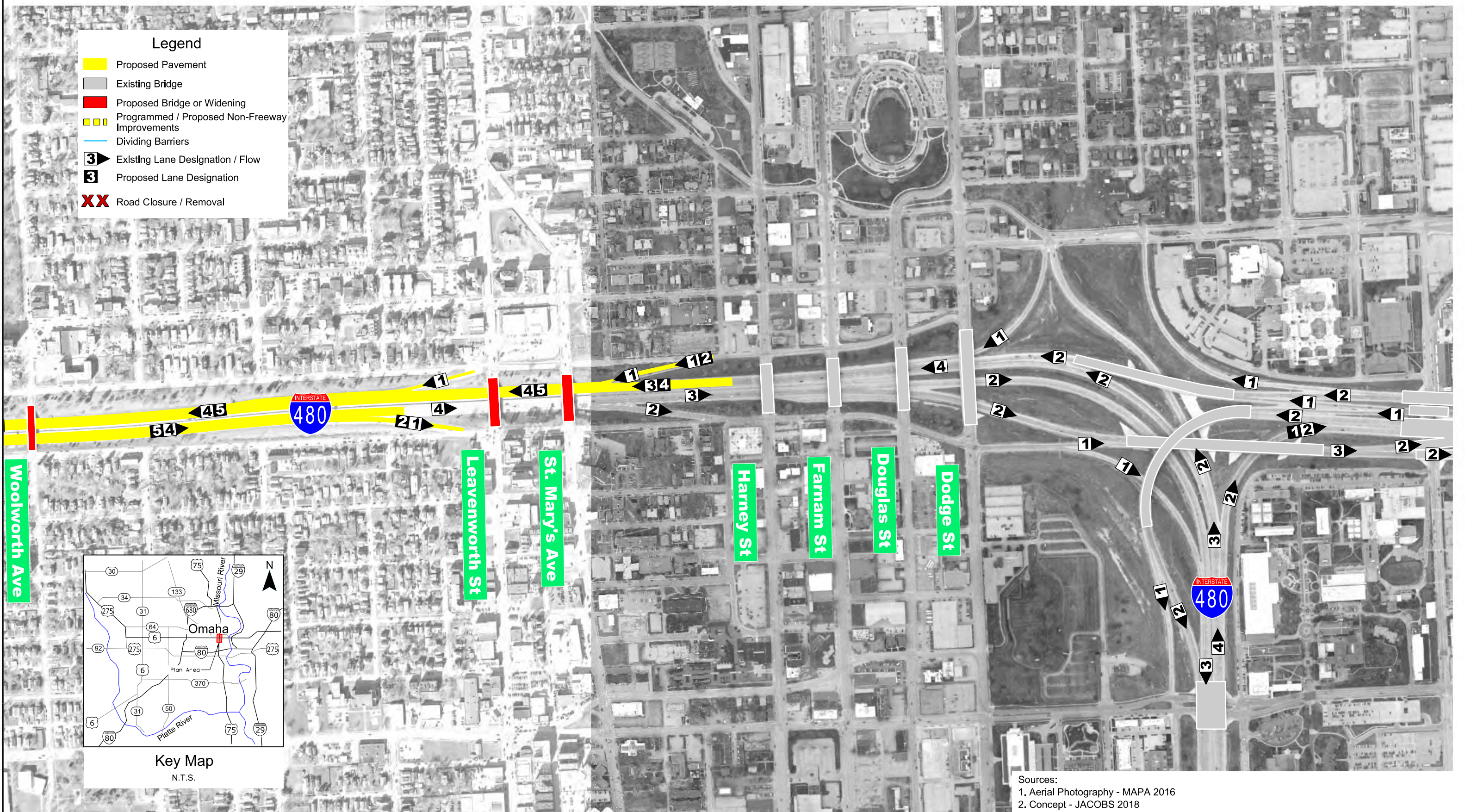

- Legend**
- Proposed Pavement
  - Existing Bridge
  - Proposed Bridge or Widening
  - Programmed / Proposed Non-Freeway Improvements
  - Dividing Barriers
  - 3 Existing Lane Designation / Flow
  - 3 Proposed Lane Designation
  - XX Road Closure / Removal

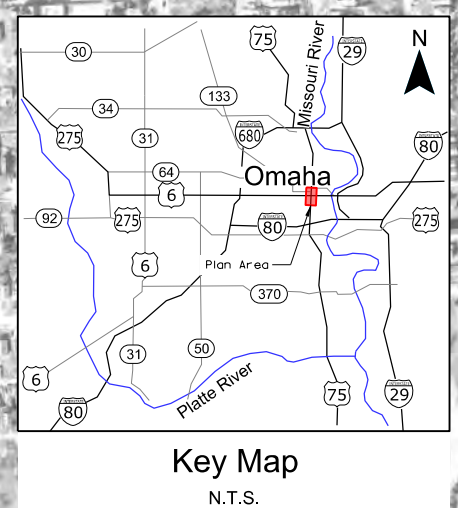

Sources:  
 1. Aerial Photography - MAPA 2016  
 2. Concept - JACOBS 2018

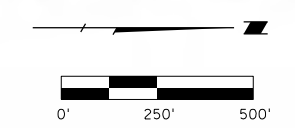

**PRELIMINARY PLAN**  
 NOT FINAL - SUBJECT TO CHANGE



**I-480** I-480 Recommended Concept  
 Metro Area Travel Improvement Study  
 Douglas and Sarpy County, Nebraska

March 2019  
 Figure 2

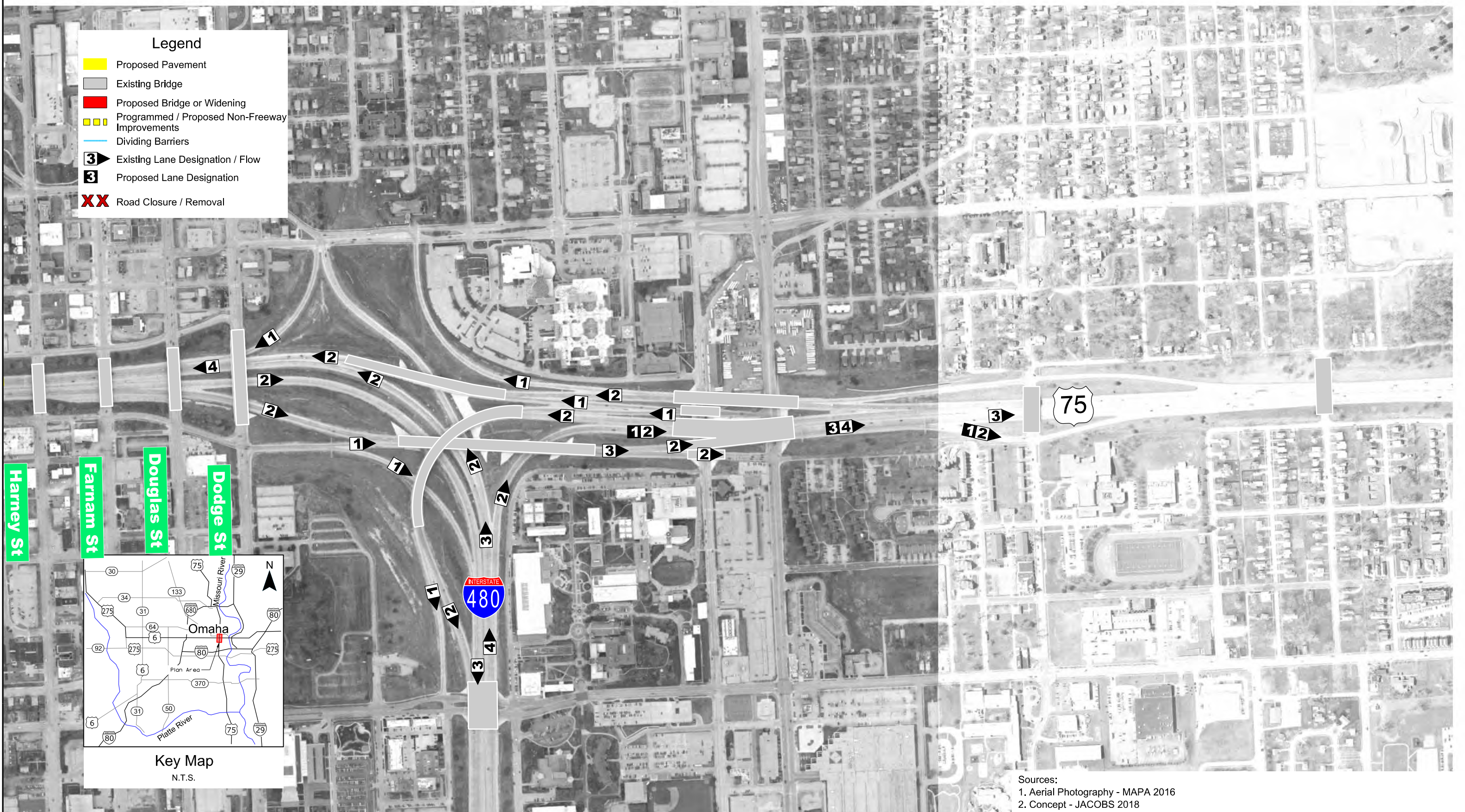

- Legend**
- Proposed Pavement
  - Existing Bridge
  - Proposed Bridge or Widening
  - Programmed / Proposed Non-Freeway Improvements
  - Dividing Barriers
  - 3 Existing Lane Designation / Flow
  - 3 Proposed Lane Designation
  - XX Road Closure / Removal

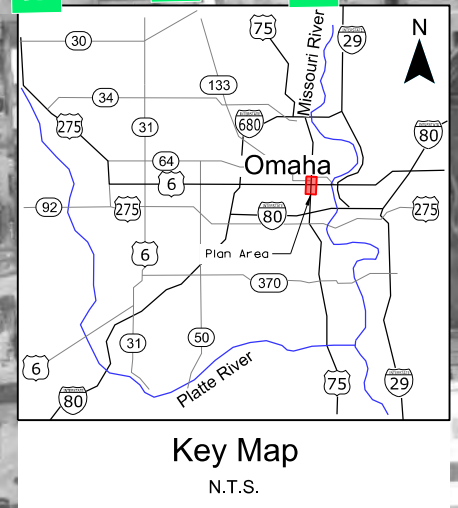

Sources:  
 1. Aerial Photography - MAPA 2016  
 2. Concept - JACOBS 2018

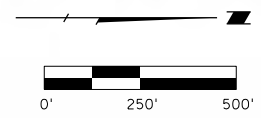

**PRELIMINARY PLAN**  
 NOT FINAL - SUBJECT TO CHANGE



**I-480** I-480 Recommended Concept  
 Metro Area Travel Improvement Study  
 Douglas and Sarpy County, Nebraska

March 2019  
 Figure 3

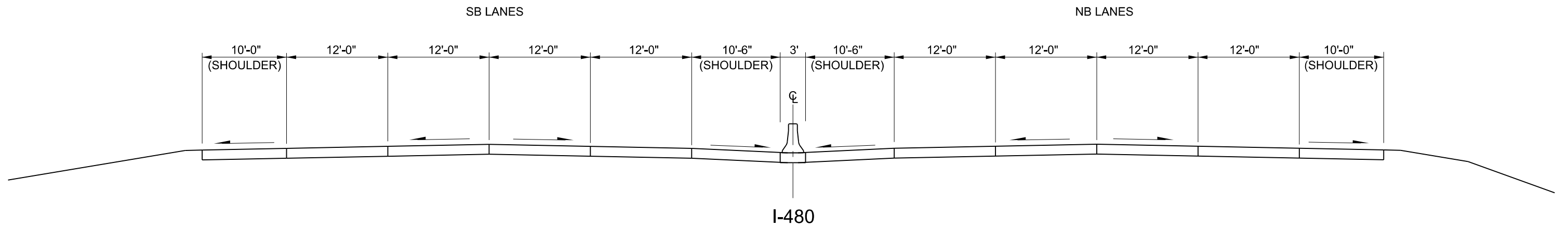

EXISTING CONDITIONS  
BETWEEN MARTHA ST AND LEAVENWORTH ST

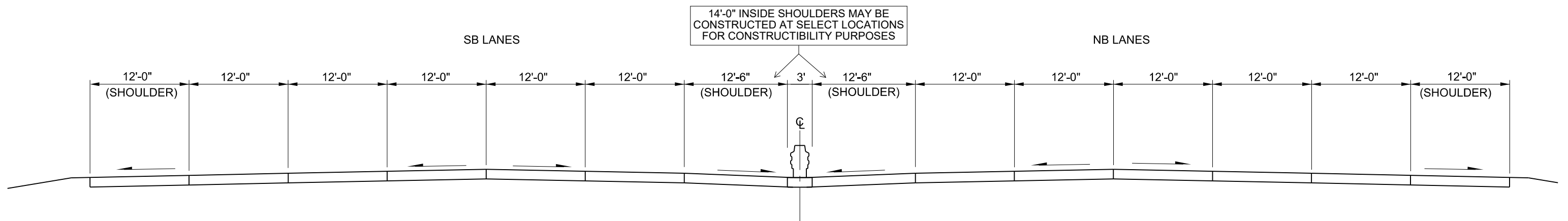

I-480 RECOMMENDED CONCEPT

PROPOSED CONDITIONS  
BETWEEN MARTHA ST AND LEAVENWORTH ST

**PRELIMINARY PLAN**  
NOT FINAL - SUBJECT TO CHANGE



Typical Sections  
Between Martha St and Leavenworth St  
Metro Area Travel Improvement Study  
Douglas and Sarpy County, Nebraska

March 2019

Figure 4

This page intentionally left blank



## Appendix D - I-680

### *Figures Included in Appendix D:*

- I-680 Recommended Concept: Figures 1–6
- I-680 Typical Section: Figure 7

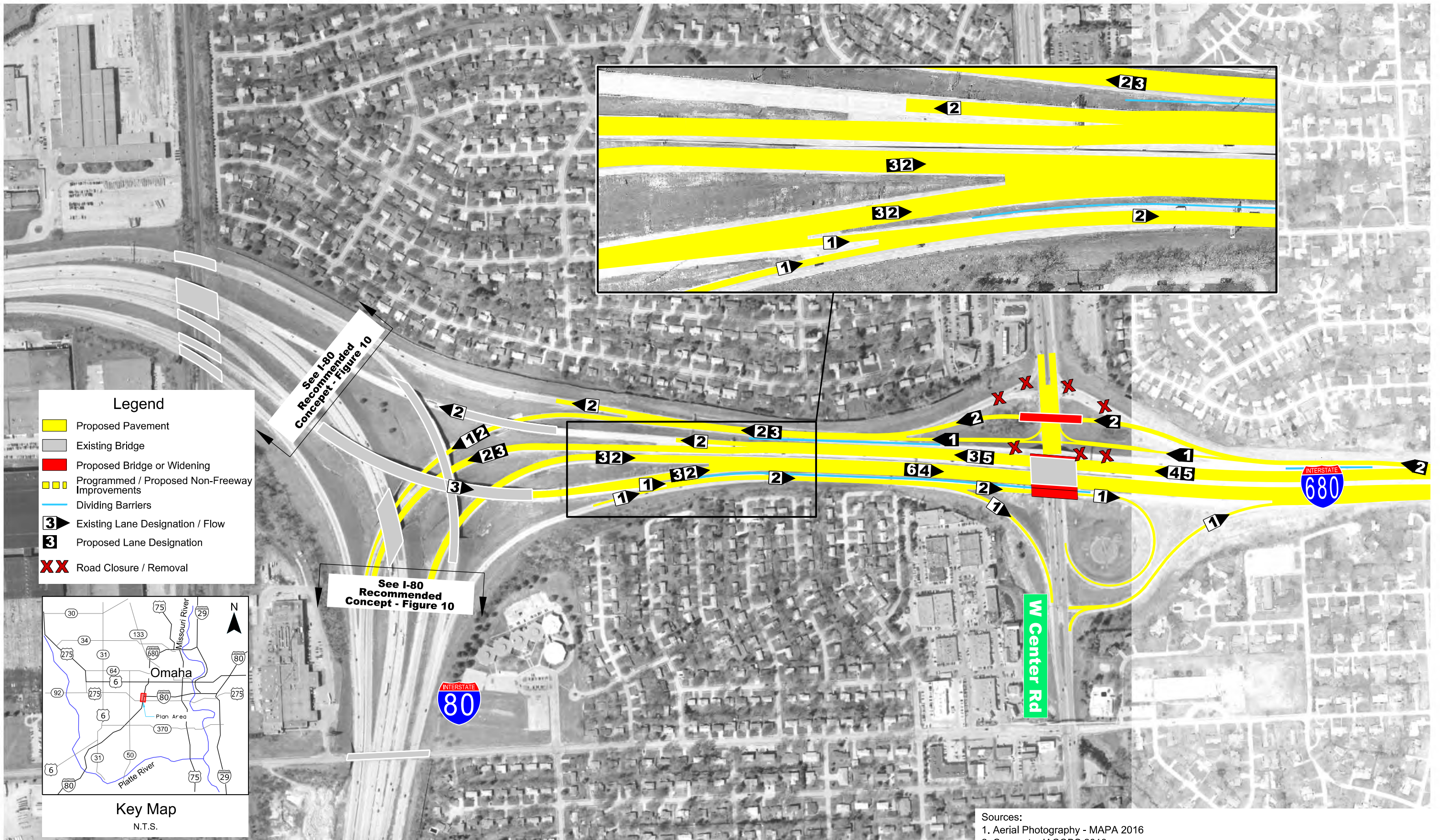

- Legend**
- Proposed Pavement
  - Existing Bridge
  - Proposed Bridge or Widening
  - Programmed / Proposed Non-Freeway Improvements
  - Dividing Barriers
  - 3 Existing Lane Designation / Flow
  - 3 Proposed Lane Designation
  - XX Road Closure / Removal

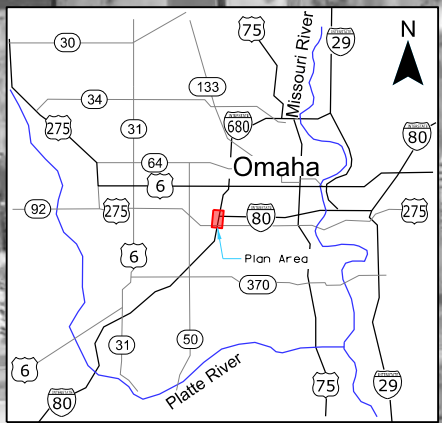

Sources:  
 1. Aerial Photography - MAPA 2016  
 2. Concept - JACOBS 2018

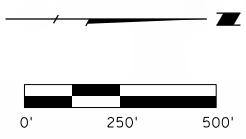

**PRELIMINARY PLAN**  
 NOT FINAL - SUBJECT TO CHANGE



**I-680 Recommended Concept**  
 Metro Area Travel Improvement Study  
 Douglas and Sarpy County, Nebraska

March 2019  
 Figure 1



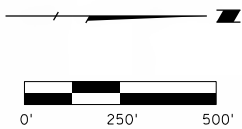
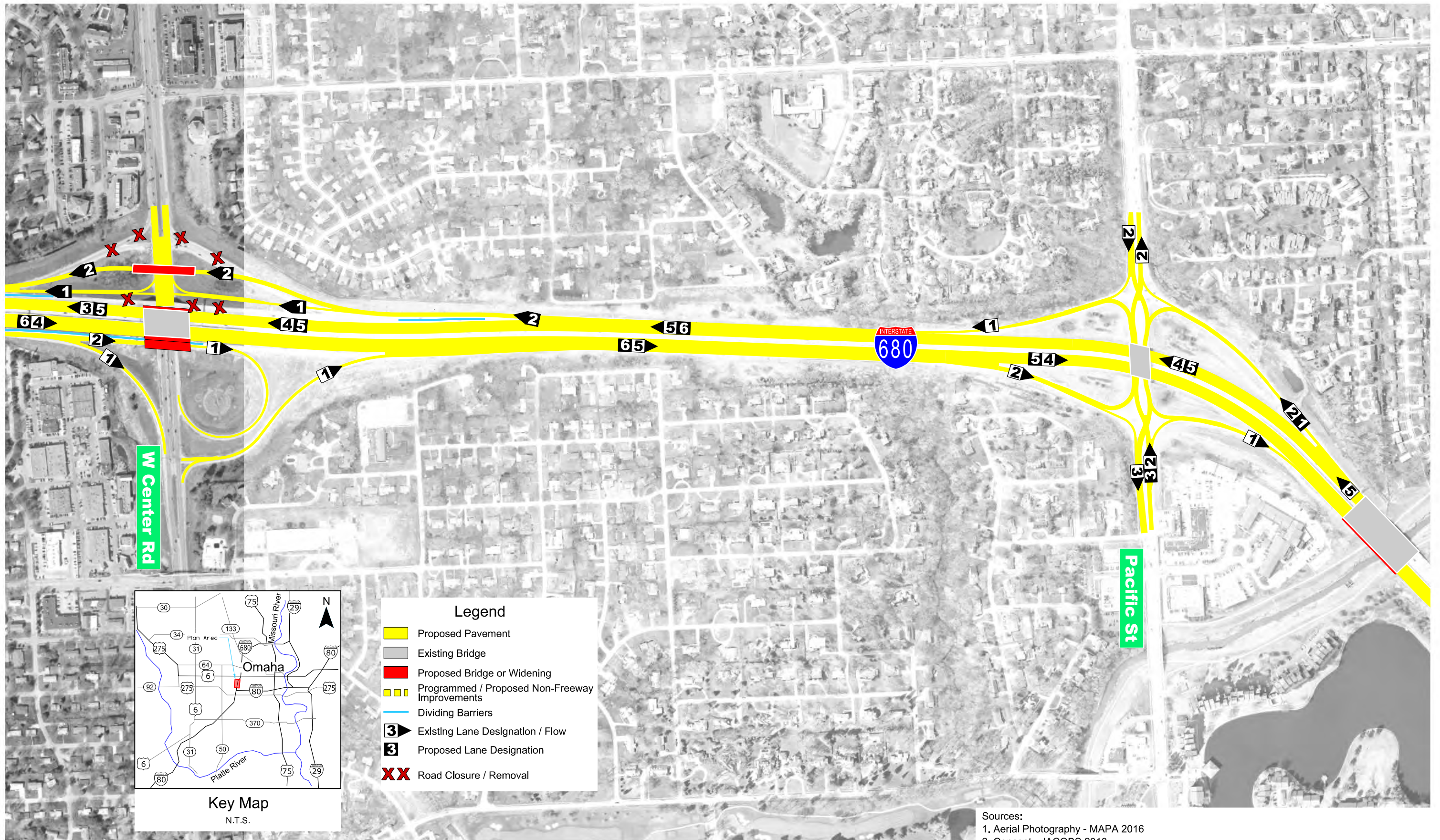

**PRELIMINARY PLAN**  
NOT FINAL - SUBJECT TO CHANGE



I-680 Recommended Concept

Metro Area Travel Improvement Study  
Douglas and Sarpy County, Nebraska

March 2019

Figure 2

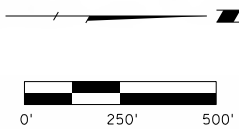
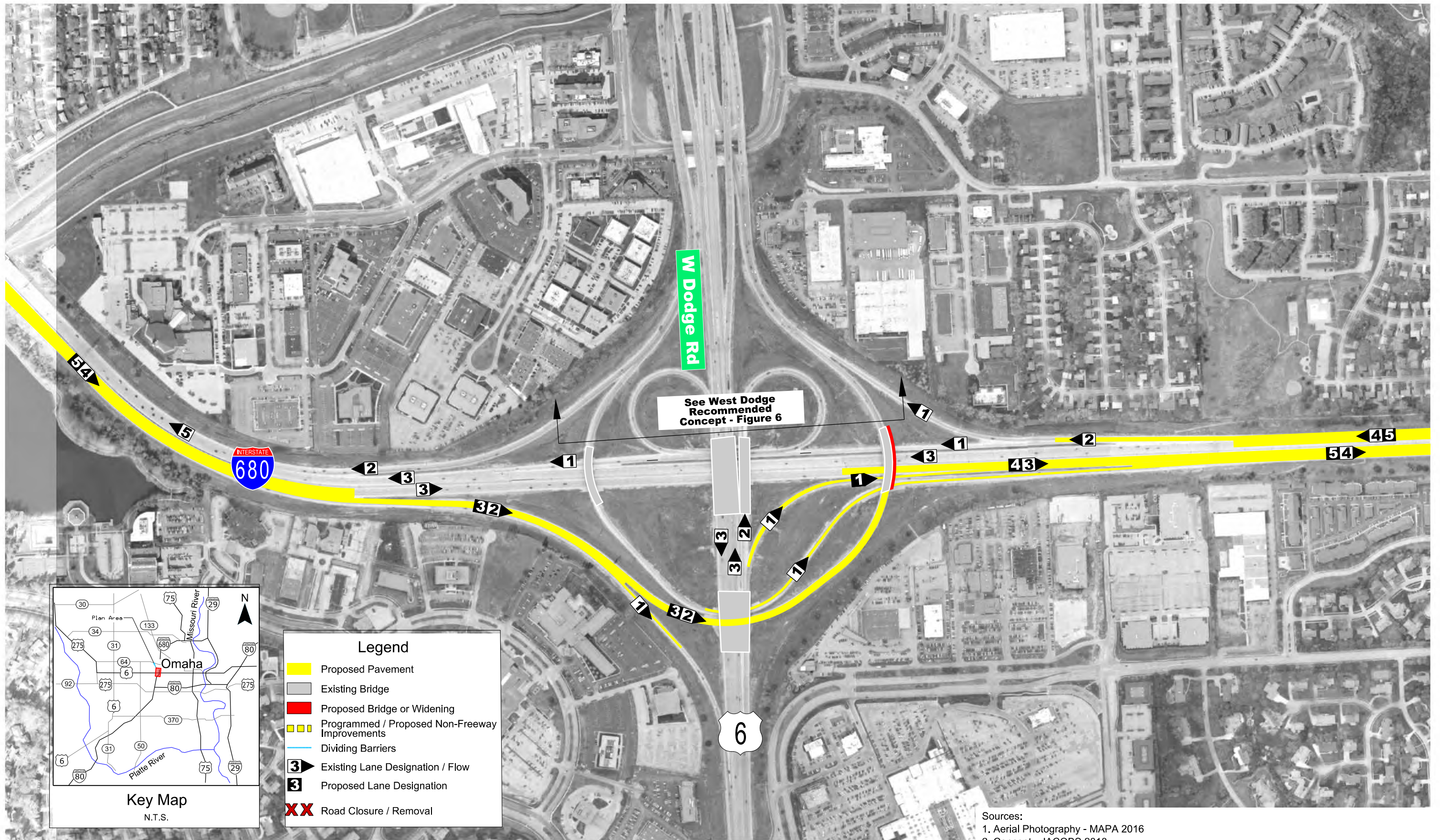

**PRELIMINARY PLAN**  
NOT FINAL - SUBJECT TO CHANGE



**I-680 Recommended Concept**

Metro Area Travel Improvement Study  
Douglas and Sarpy County, Nebraska

March 2019

Figure 3

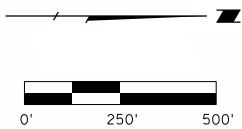
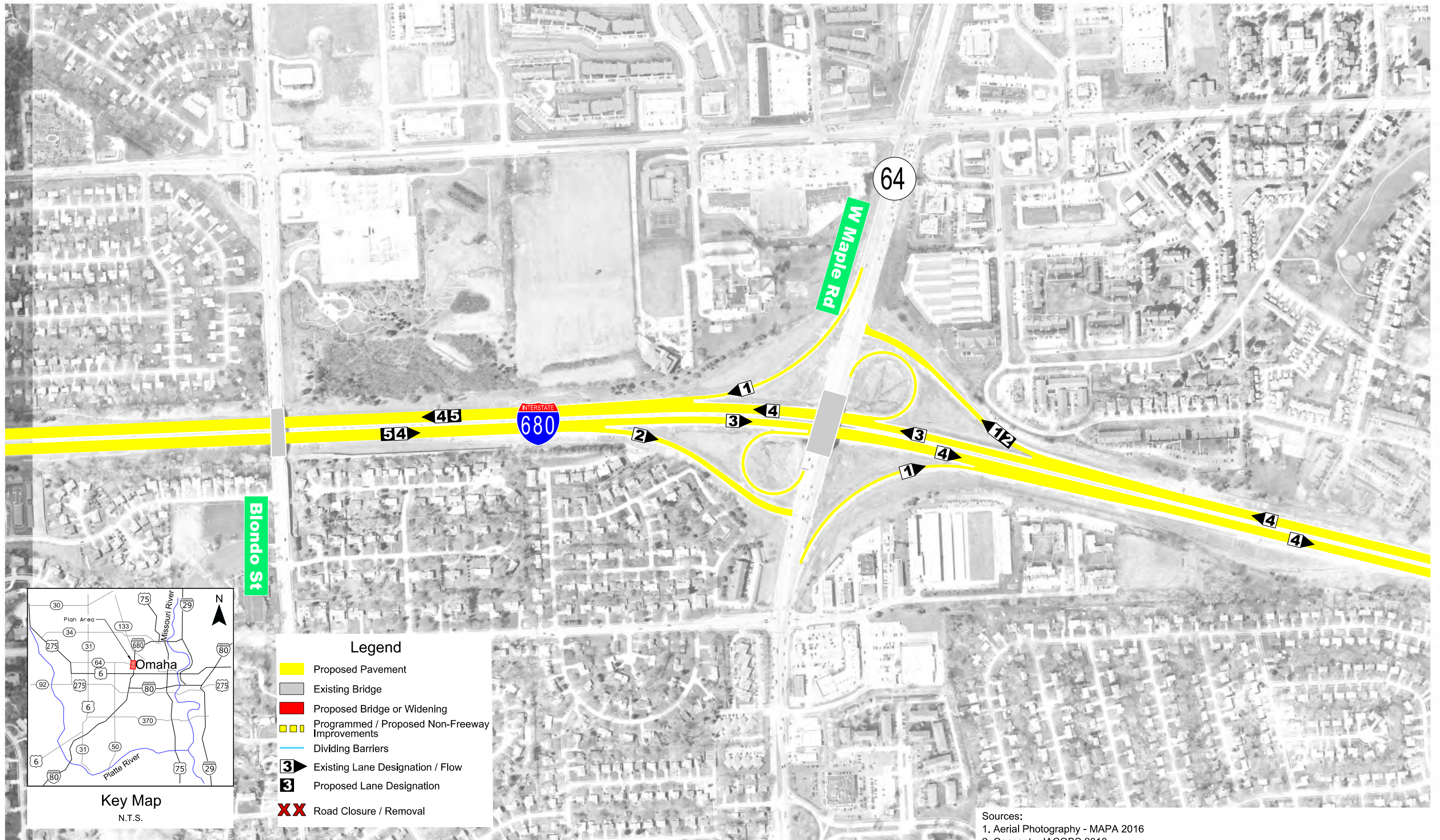

**PRELIMINARY PLAN**  
NOT FINAL - SUBJECT TO CHANGE



**I-680 Recommended Concept**

Metro Area Travel Improvement Study  
Douglas and Sarpy County, Nebraska

March 2019

Figure 4

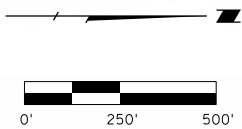
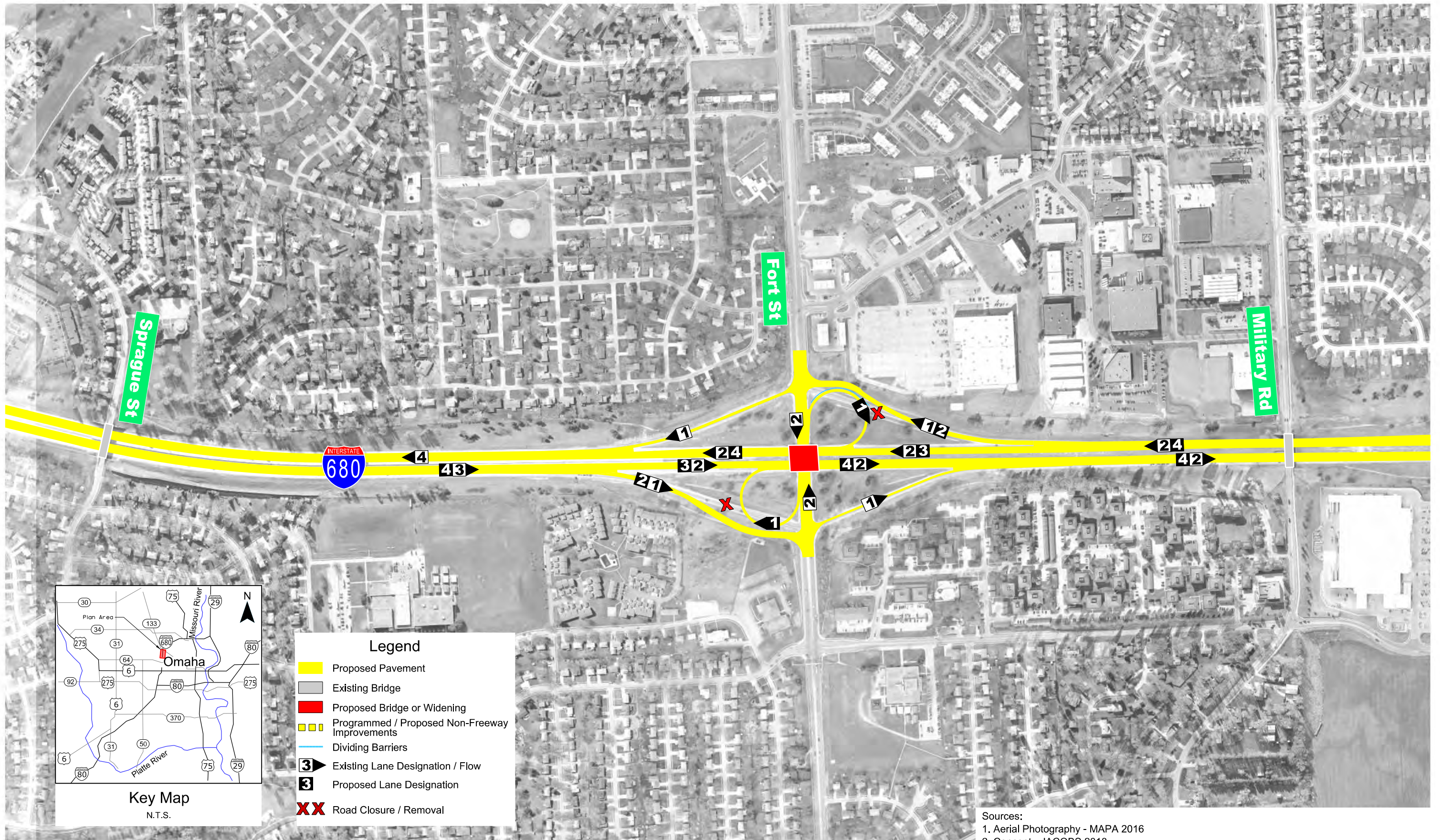

**PRELIMINARY PLAN**  
NOT FINAL - SUBJECT TO CHANGE



**I-680 Recommended Concept**

Metro Area Travel Improvement Study  
Douglas and Sarpy County, Nebraska

March 2019

Figure 5

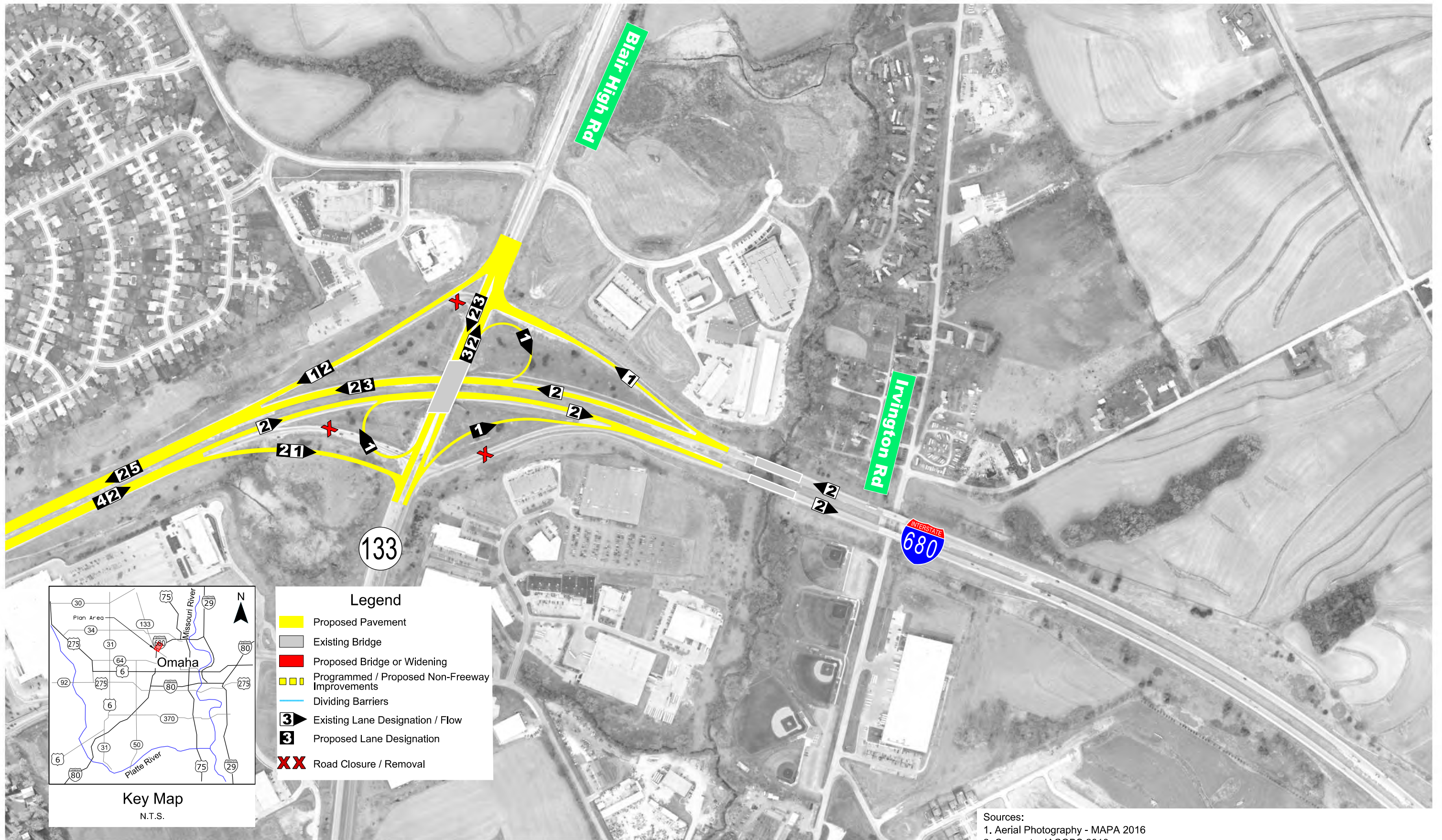

**Legend**

- Proposed Pavement
- Existing Bridge
- Proposed Bridge or Widening
- Programmed / Proposed Non-Freeway Improvements
- Dividing Barriers
- ▶ Existing Lane Designation / Flow
- ▶ Proposed Lane Designation
- XX Road Closure / Removal

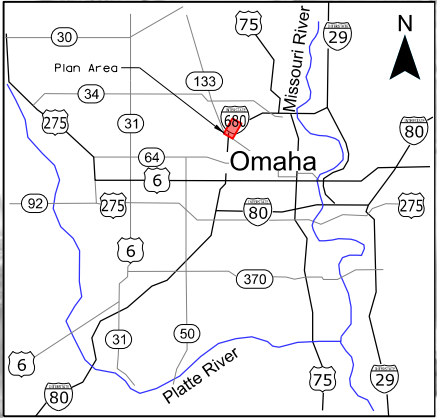

Sources:  
 1. Aerial Photography - MAPA 2016  
 2. Concept - JACOBS 2018

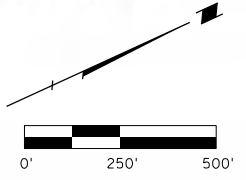

**PRELIMINARY PLAN**  
 NOT FINAL - SUBJECT TO CHANGE



**I-680 Recommended Concept**  
 Metro Area Travel Improvement Study  
 Douglas and Sarpy County, Nebraska

March 2019  
 Figure 6

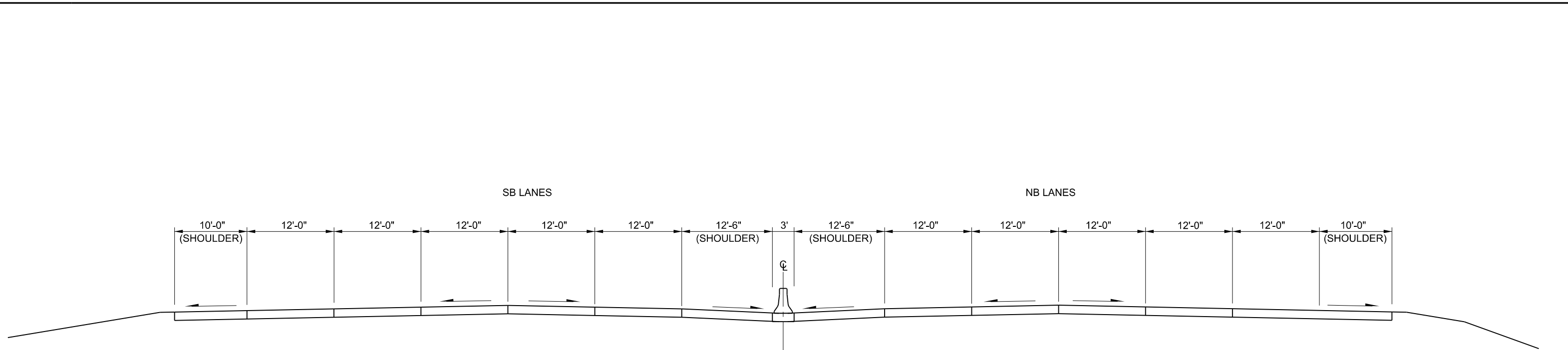

I-680  
EXISTING CONDITIONS  
BETWEEN WEST CENTER RD AND PACIFIC ST

14'-0" INSIDE SHOULDERS MAY BE  
CONSTRUCTED AT SELECT LOCATIONS  
FOR CONSTRUCTIBILITY PURPOSES

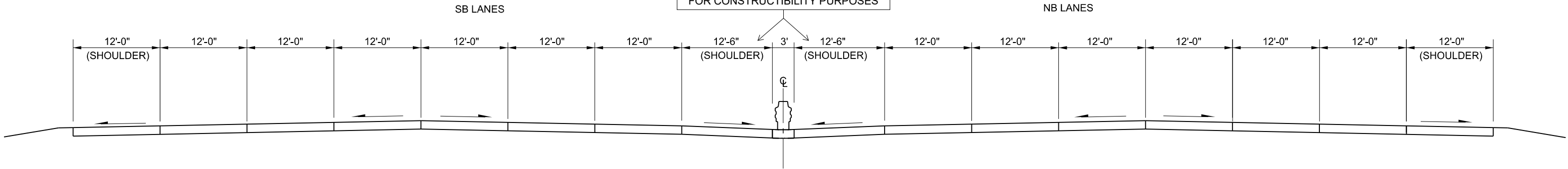

I-680 RECOMMENDED CONCEPT  
PROPOSED CONDITIONS  
BETWEEN WEST CENTER RD AND PACIFIC ST

**PRELIMINARY PLAN**  
NOT FINAL - SUBJECT TO CHANGE



 **Typical Sections**  
Between West Center Rd and Pacific St  
Metro Area Travel Improvement Study  
Douglas and Sarpy County, Nebraska

March 2019

Figure 7



## Appendix E - US-75 (Kennedy Freeway)

### *Figures Included in Appendix E:*

- US-75 Recommended Concept: Figures 1–5
- US-75 Typical Sections: Figures 6–8

**Legend**

- Proposed Pavement
- Existing Bridge
- Proposed Bridge or Widening
- Programmed / Proposed Non-Freeway Improvements
- Dividing Barriers
- Existing Lane Designation / Flow
- Proposed Lane Designation
- XX Road Closure / Removal

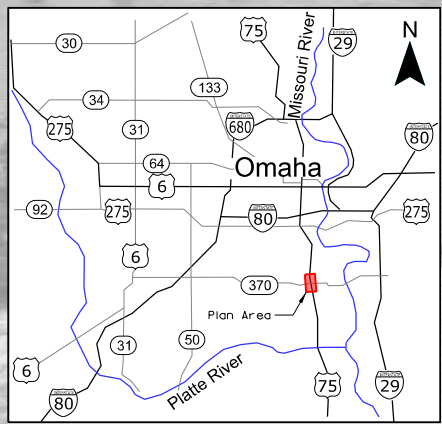
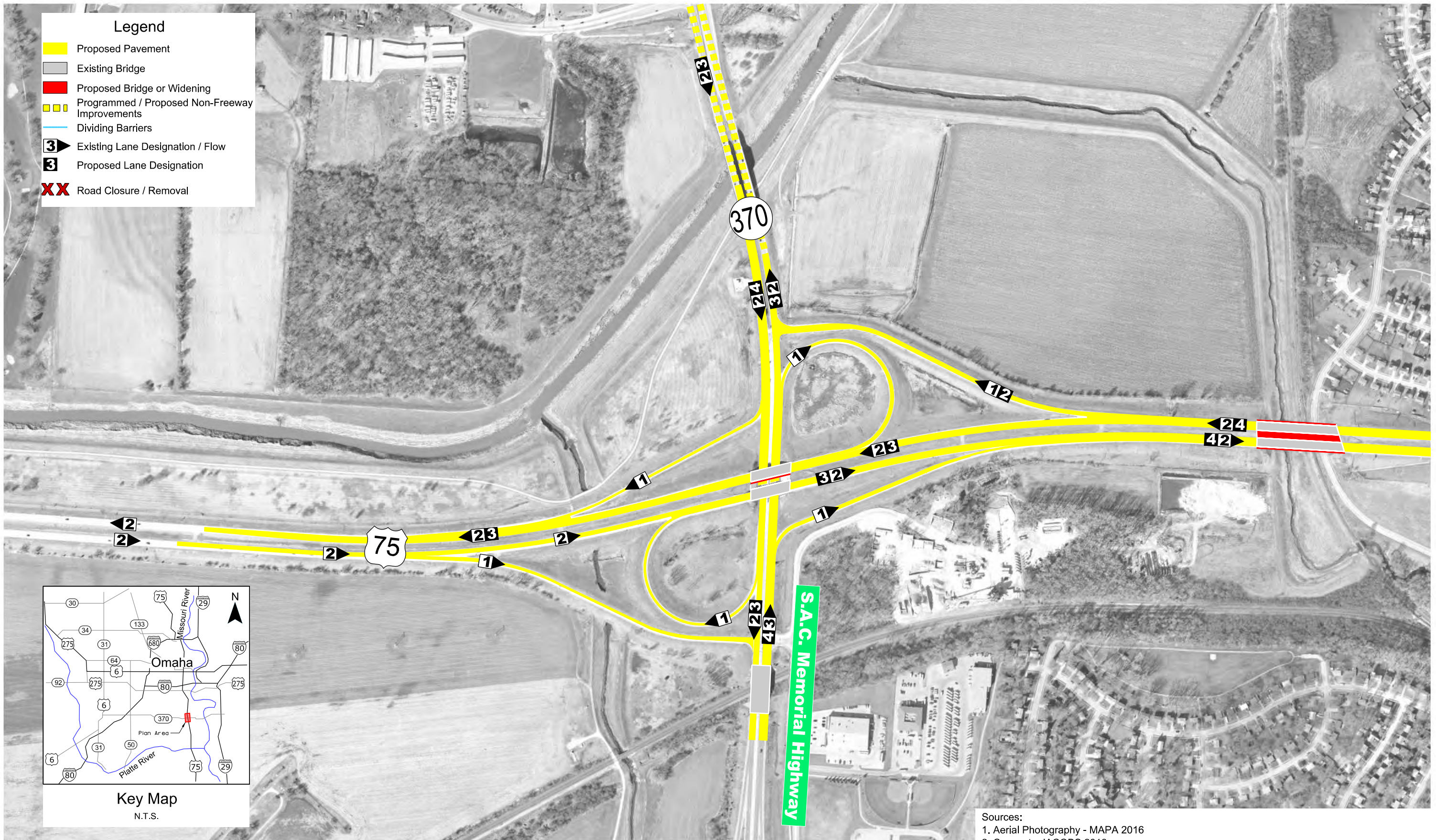

**Key Map**  
N.T.S.

Sources:  
 1. Aerial Photography - MAPA 2016  
 2. Concept - JACOBS 2018

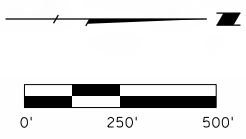

**PRELIMINARY PLAN**  
 NOT FINAL - SUBJECT TO CHANGE



**75** Kennedy Freeway Recommended Concept  
 Metro Area Travel Improvement Study  
 Douglas and Sarpy County, Nebraska

March 2019  
 Figure 1



- Legend**
- Proposed Pavement
  - Existing Bridge
  - Proposed Bridge or Widening
  - Programmed / Proposed Non-Freeway Improvements
  - Dividing Barriers
  - Existing Lane Designation / Flow
  - Proposed Lane Designation
  - XX** Road Closure / Removal

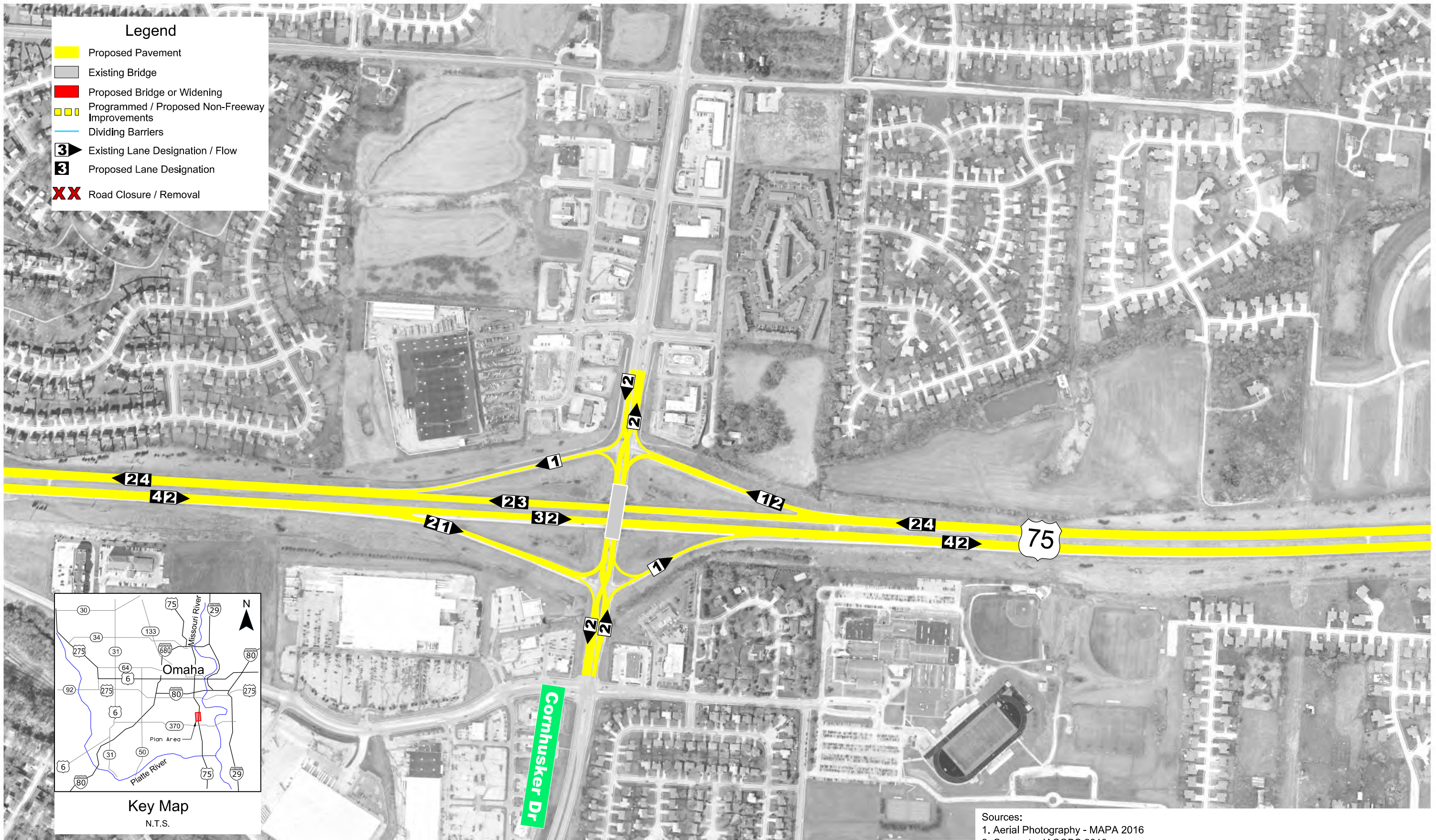

Sources:  
 1. Aerial Photography - MAPA 2016  
 2. Concept - JACOBS 2018

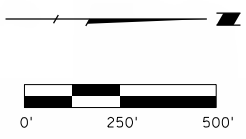

**PRELIMINARY PLAN**  
 NOT FINAL - SUBJECT TO CHANGE



**75** Kennedy Freeway Recommended Concept  
 Metro Area Travel Improvement Study  
 Douglas and Sarpy County, Nebraska

March 2019  
 Figure 2

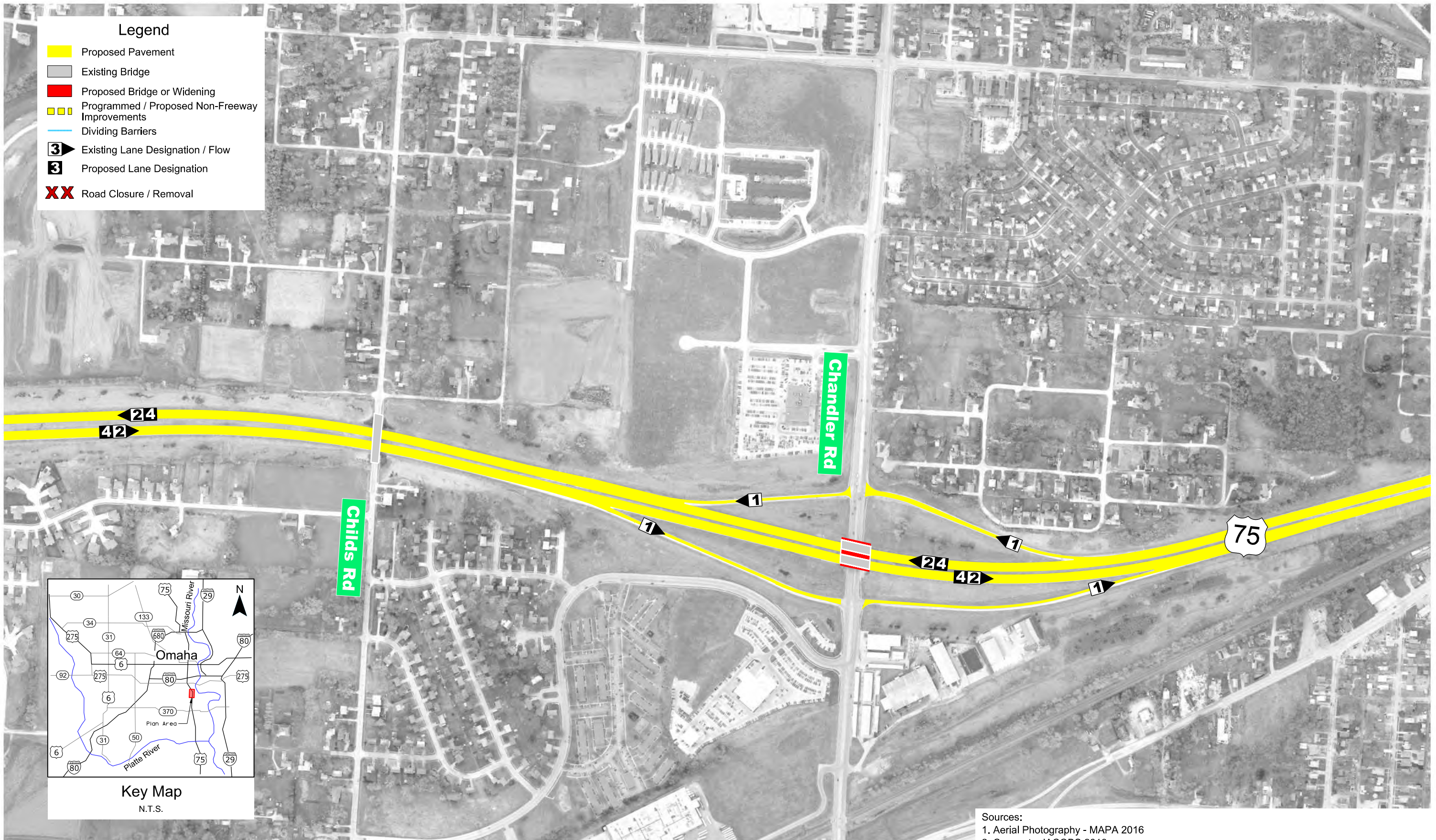

- Legend**
- Proposed Pavement
  - Existing Bridge
  - Proposed Bridge or Widening
  - Programmed / Proposed Non-Freeway Improvements
  - Dividing Barriers
  - Existing Lane Designation / Flow
  - Proposed Lane Designation
  - Road Closure / Removal

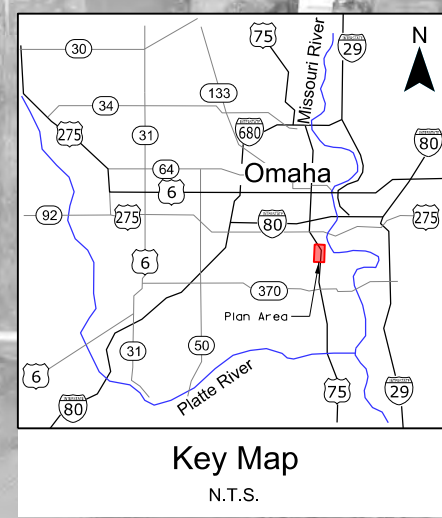

Sources:  
 1. Aerial Photography - MAPA 2016  
 2. Concept - JACOBS 2018

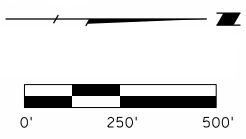

**PRELIMINARY PLAN**  
 NOT FINAL - SUBJECT TO CHANGE



**75 Kennedy Freeway Recommended Concept**  
 Metro Area Travel Improvement Study  
 Douglas and Sarpy County, Nebraska

March 2019  
 Figure 3

- Legend**
- Proposed Pavement
  - Existing Bridge
  - Proposed Bridge or Widening
  - Programmed / Proposed Non-Freeway Improvements
  - Dividing Barriers
  - Existing Lane Designation / Flow
  - Proposed Lane Designation
  - XX Road Closure / Removal

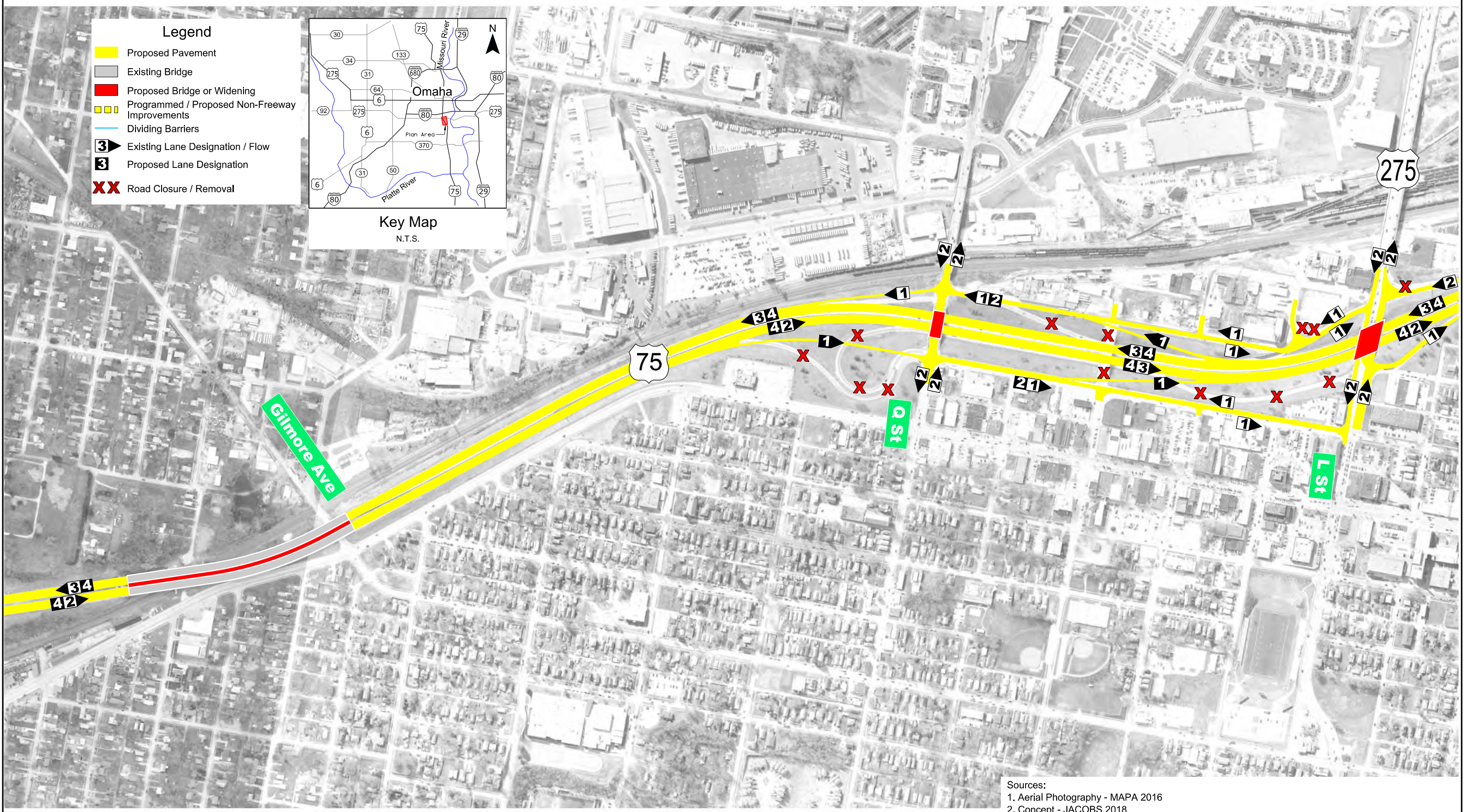
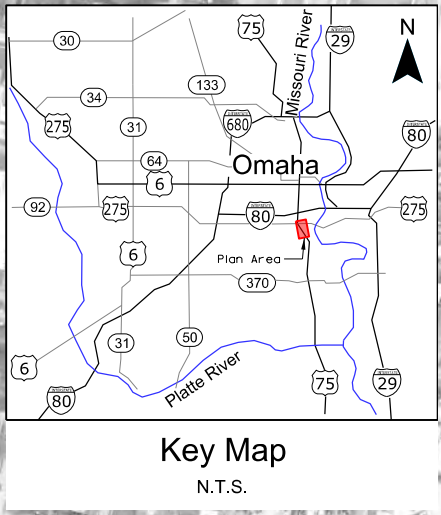

Sources:  
 1. Aerial Photography - MAPA 2016  
 2. Concept - JACOBS 2018

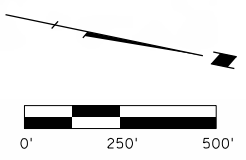

PRELIMINARY PLAN  
NOT FINAL - SUBJECT TO CHANGE



**75** Kennedy Freeway Recommended Concept  
 Metro Area Travel Improvement Study  
 Douglas and Sarpy County, Nebraska

March 2019  
 Figure 4

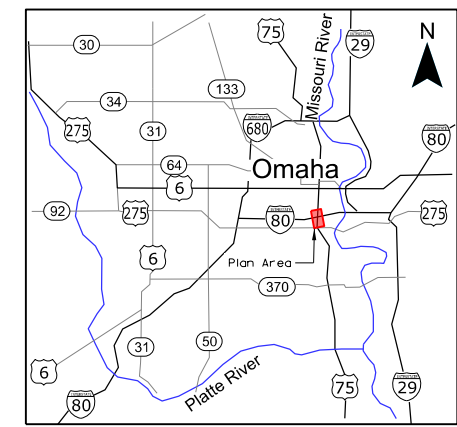
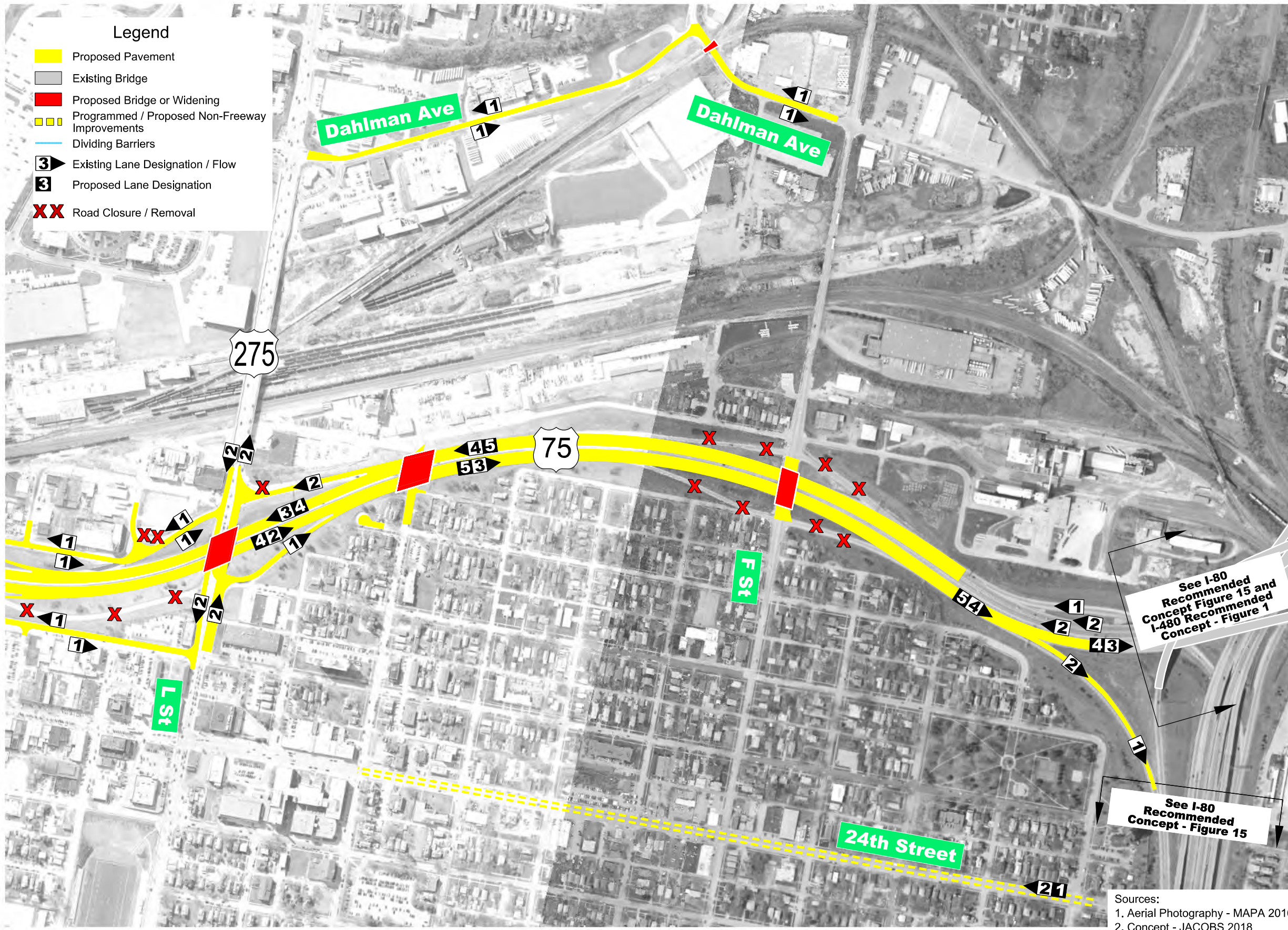

Key Map  
N.T.S.

Sources:  
1. Aerial Photography - MAPA 2016  
2. Concept - JACOBS 2018

**75** Kennedy Freeway Recommended Concept  
Metro Area Travel Improvement Study  
Douglas and Sarpy County, Nebraska

March 2019  
Figure 5

**PRELIMINARY PLAN**  
NOT FINAL - SUBJECT TO CHANGE

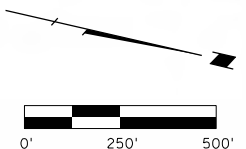

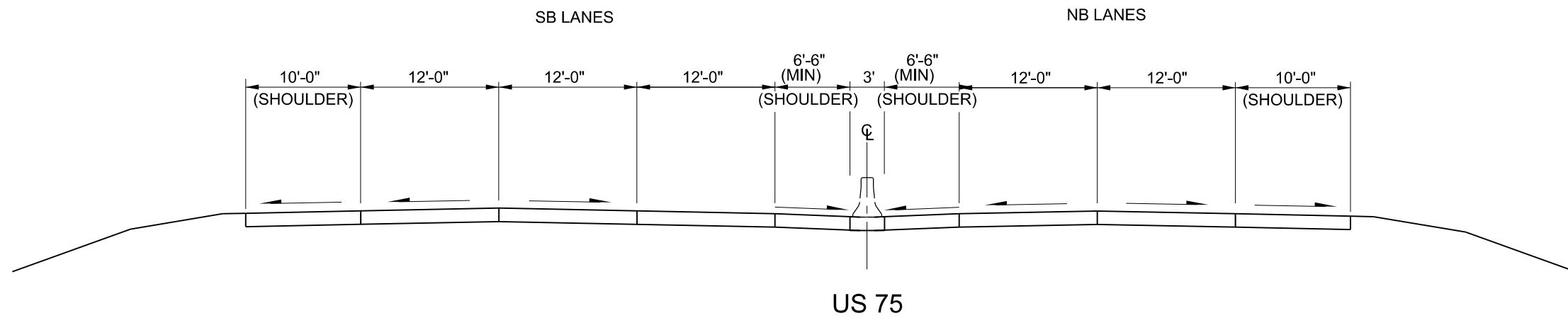

US 75  
EXISTING CONDITIONS  
BETWEEN CHANDLER RD AND Q ST

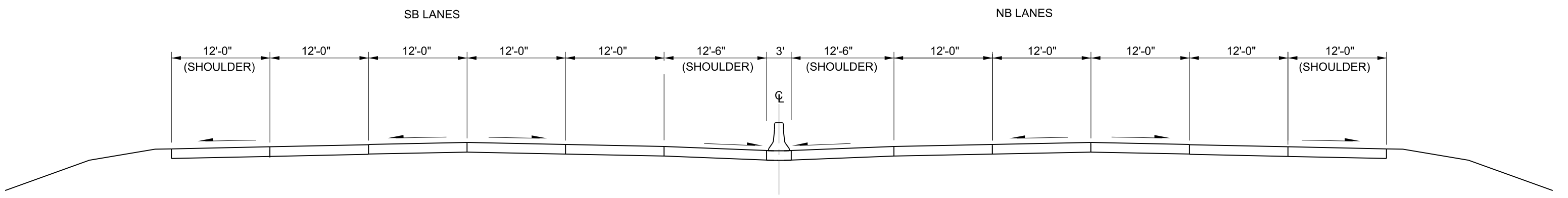

US 75 RECOMMENDED CONCEPT  
PROPOSED CONDITIONS  
BETWEEN CHANDLER RD AND Q ST

**PRELIMINARY PLAN**  
NOT FINAL - SUBJECT TO CHANGE



**75** Typical Sections  
Between Chandler Rd and Q St  
Metro Area Travel Improvement Study  
Douglas and Sarpy County, Nebraska

March 2019

Figure 6

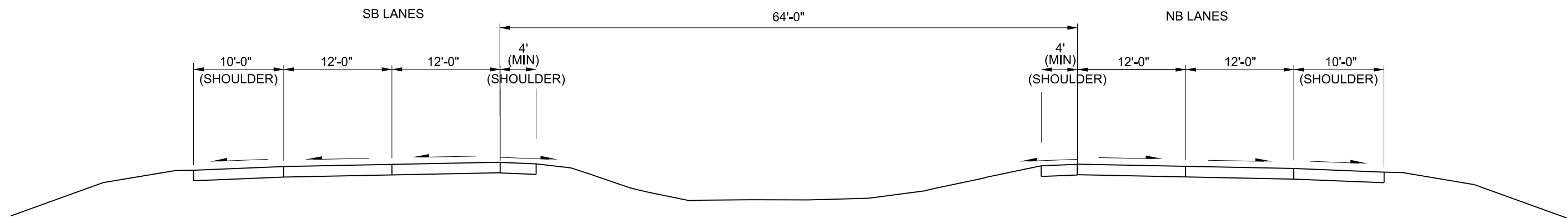

US 75  
EXISTING CONDITIONS  
BETWEEN N-370 AND CORNHUSKER

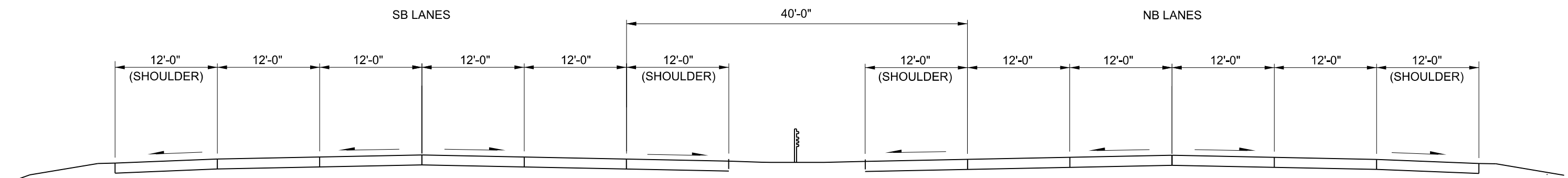

US 75 RECOMMENDED CONCEPT  
PROPOSED CONDITIONS  
BETWEEN N-370 AND CORNHUSKER

**PRELIMINARY PLAN**  
NOT FINAL - SUBJECT TO CHANGE



**75** Typical Sections  
Between N-370 and Cornhusker  
Metro Area Travel Improvement Study  
Douglas and Sarpy County, Nebraska

March 2019

Figure 7

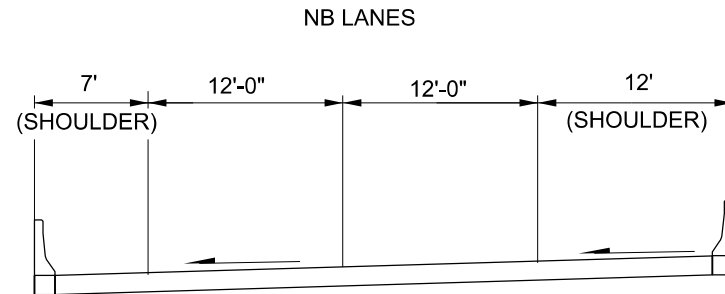
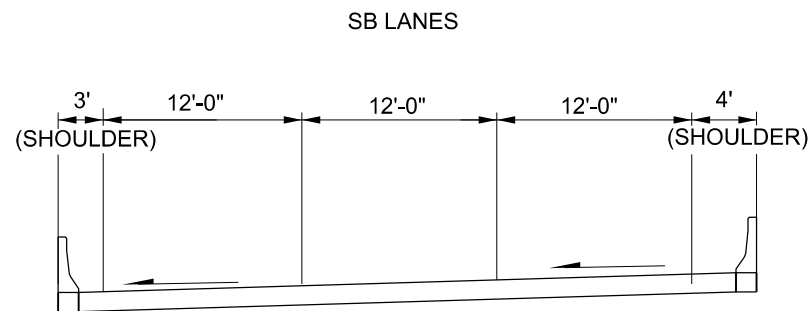

US 75  
EXISTING CONDITIONS  
UPRR BRIDGE

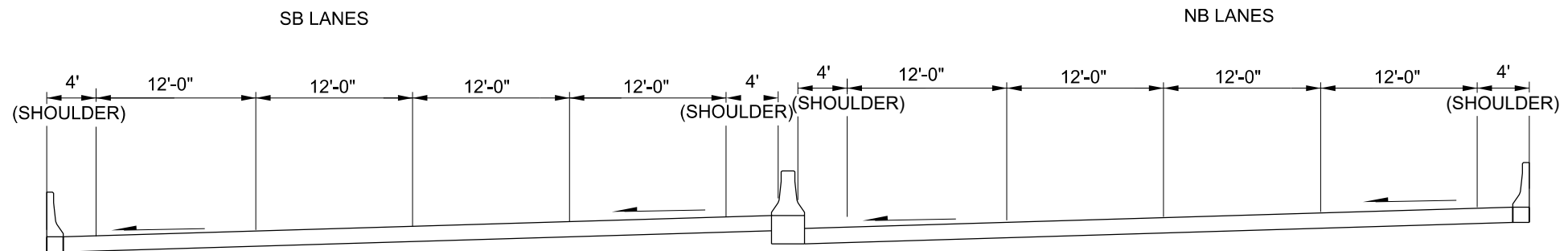

US 75 RECOMMENDED CONCEPT  
PROPOSED CONDITIONS  
UPRR BRIDGE

Note:  
1. Exact cross slopes on structure have not been determined. The structure will be widened to the inside on existing pier caps.

**PRELIMINARY PLAN**  
NOT FINAL - SUBJECT TO CHANGE

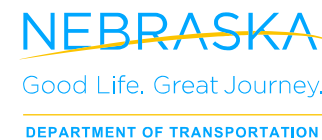

**75** Typical Sections  
UPRR Bridge  
Metro Area Travel Improvement Study  
Douglas and Sarpy County, Nebraska

March 2019

Figure 8

This page intentionally left blank





## Appendix F - US-6 (West Dodge Road)

### *Figures Included in Appendix F:*

- US-6 Recommended Concept: Figures 1–6
- US-6 Typical Sections: Figures 7–9

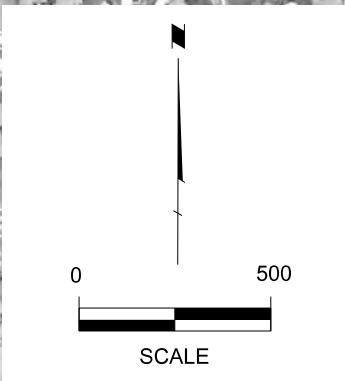
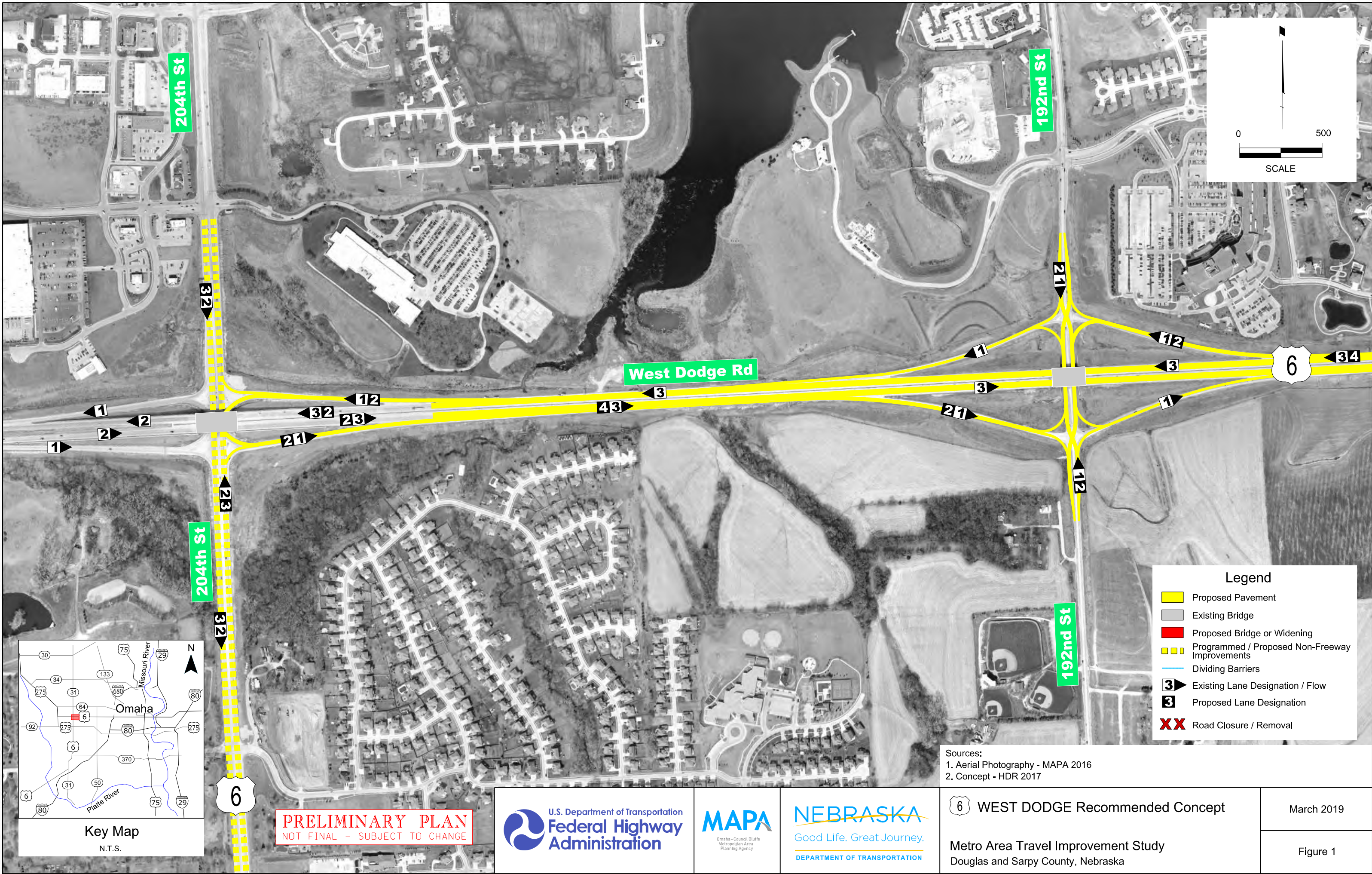

**Legend**

- Proposed Pavement
- Existing Bridge
- Proposed Bridge or Widening
- Programmed / Proposed Non-Freeway Improvements
- Dividing Barriers
- 3** Existing Lane Designation / Flow
- E** Proposed Lane Designation
- XX** Road Closure / Removal

Sources:  
 1. Aerial Photography - MAPA 2016  
 2. Concept - HDR 2017

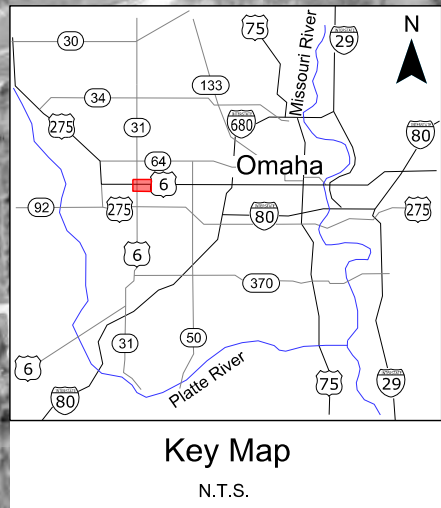

**PRELIMINARY PLAN**  
 NOT FINAL - SUBJECT TO CHANGE



<b>WEST DODGE Recommended Concept</b>	March 2019
Metro Area Travel Improvement Study Douglas and Sarpy County, Nebraska	
Figure 1	

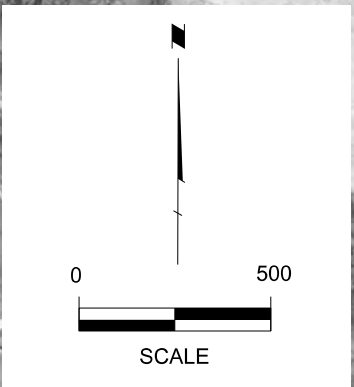
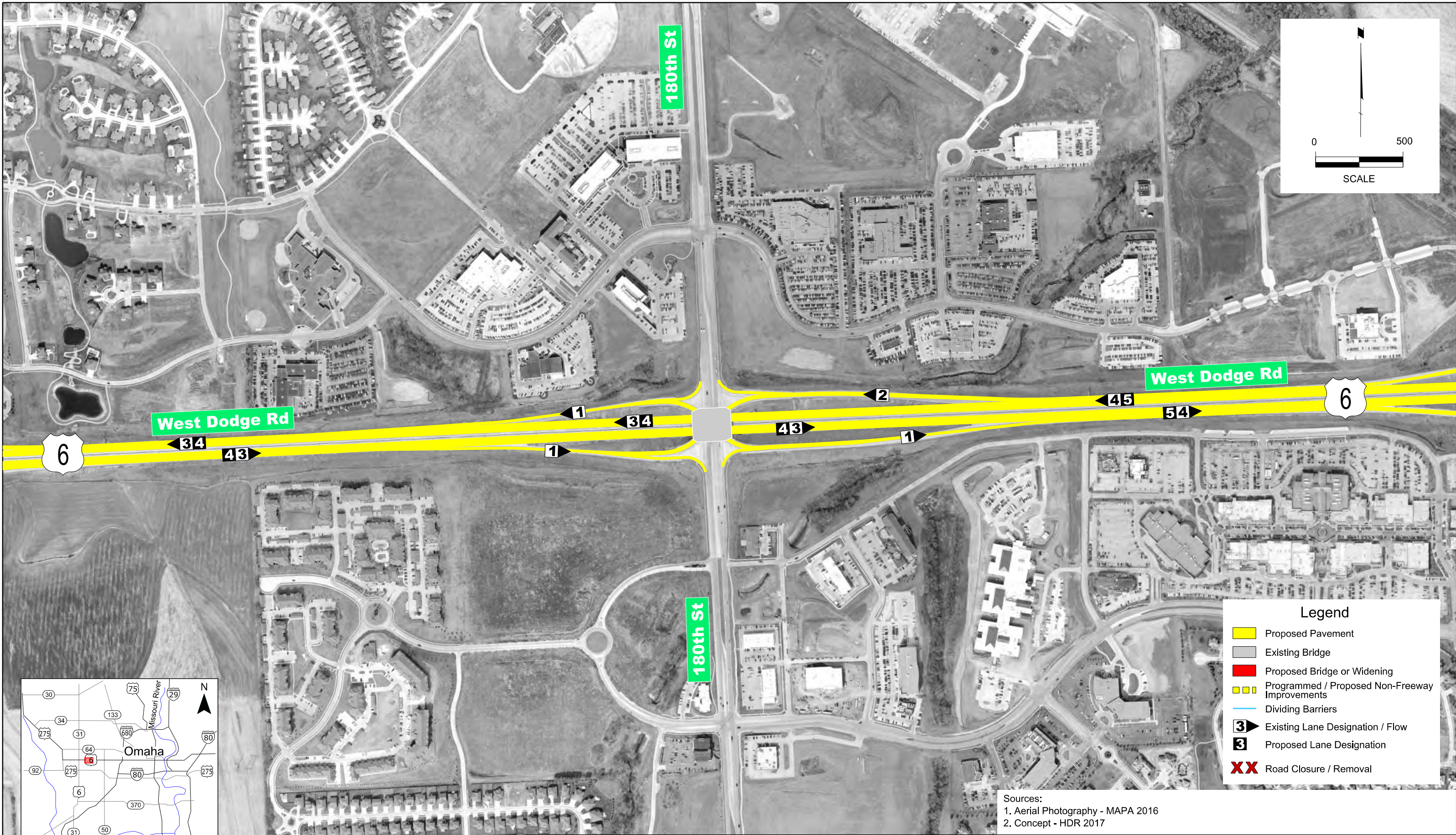

**Legend**

- Proposed Pavement
- Existing Bridge
- Proposed Bridge or Widening
- Programmed / Proposed Non-Freeway Improvements
- Dividing Barriers
- Existing Lane Designation / Flow
- Proposed Lane Designation
- Road Closure / Removal

Sources:  
 1. Aerial Photography - MAPA 2016  
 2. Concept - HDR 2017

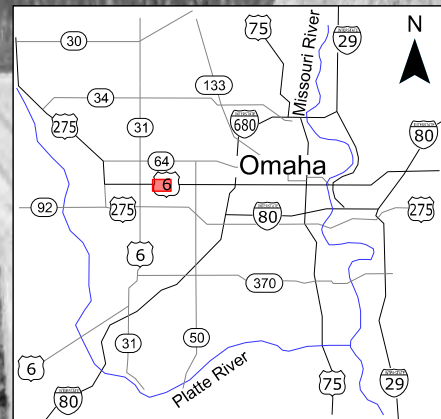

**Key Map**  
N.T.S.

**PRELIMINARY PLAN**  
 NOT FINAL - SUBJECT TO CHANGE



**6 WEST DODGE Recommended Concept**

March 2019

Metro Area Travel Improvement Study  
 Douglas and Sarpy County, Nebraska

Figure 2

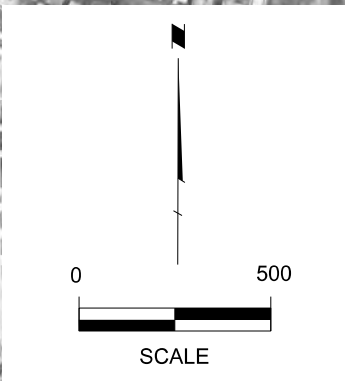
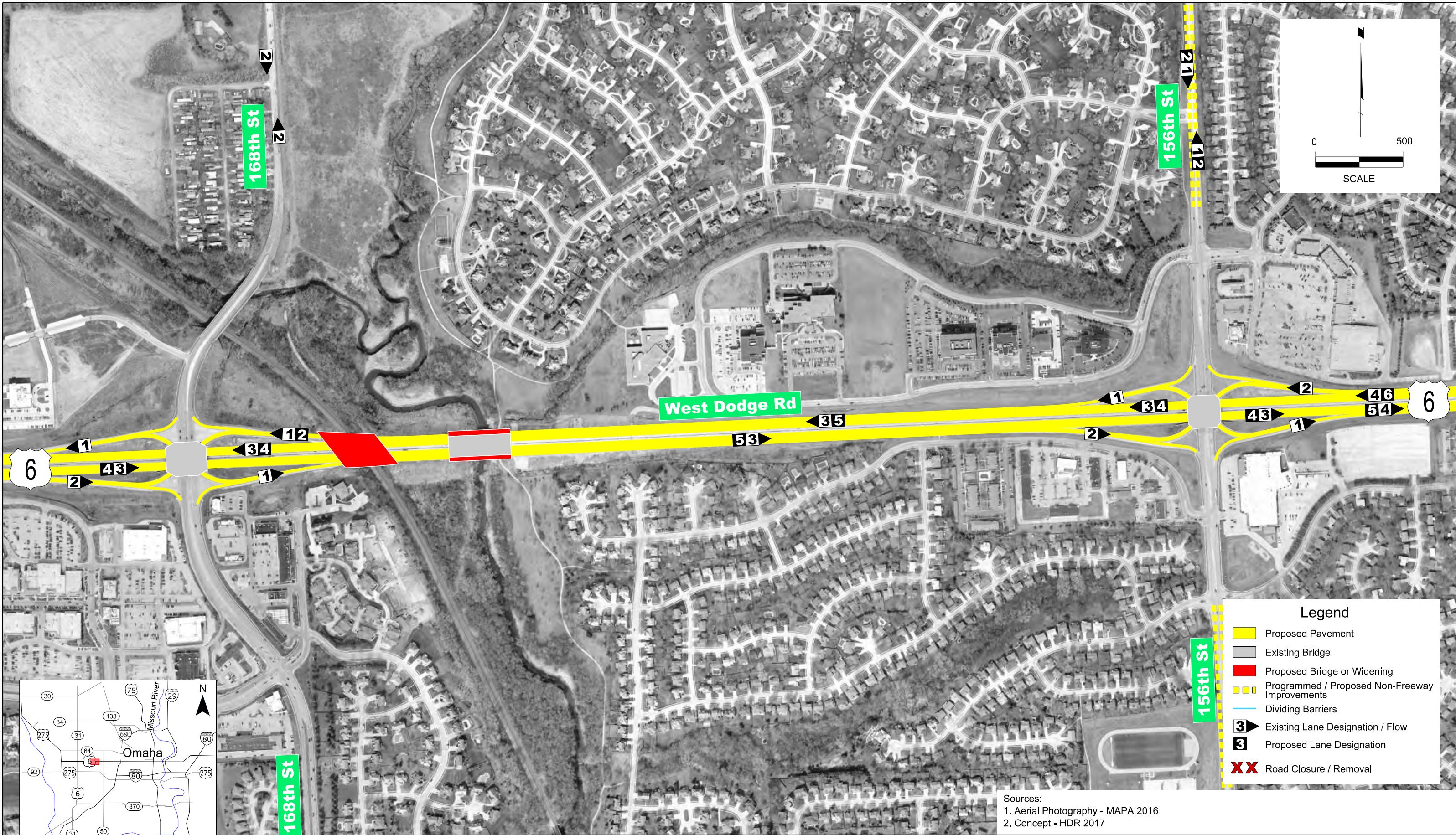

- Legend**
- Proposed Pavement
  - Existing Bridge
  - Proposed Bridge or Widening
  - Programmed / Proposed Non-Freeway Improvements
  - Dividing Barriers
  - 3 Existing Lane Designation / Flow
  - E Proposed Lane Designation
  - XX Road Closure / Removal

Sources:  
 1. Aerial Photography - MAPA 2016  
 2. Concept - HDR 2017

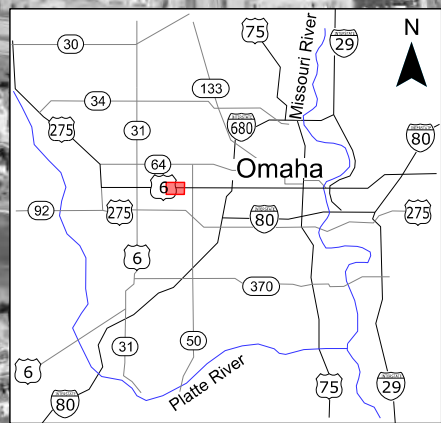

Key Map  
N.T.S.

**PRELIMINARY PLAN**  
 NOT FINAL - SUBJECT TO CHANGE



<b>WEST DODGE Recommended Concept</b>	March 2019
Metro Area Travel Improvement Study Douglas and Sarpy County, Nebraska	
Figure 3	

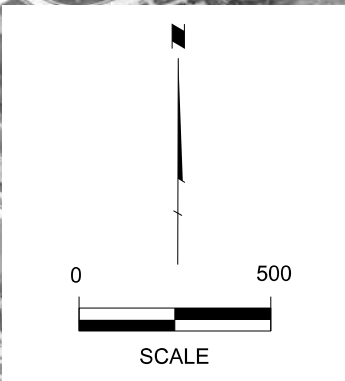
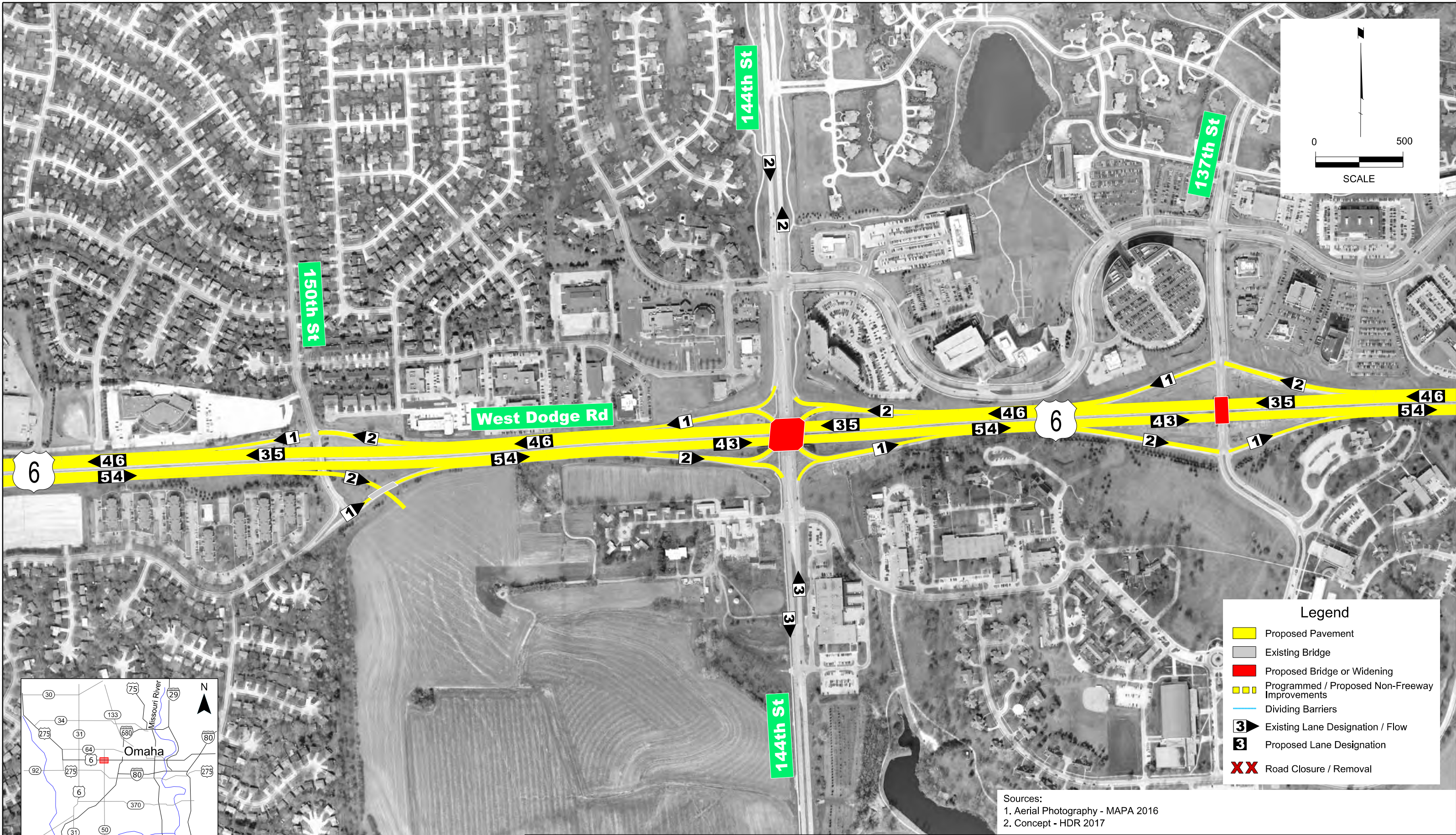

- Legend**
- Proposed Pavement
  - Existing Bridge
  - Proposed Bridge or Widening
  - Programmed / Proposed Non-Freeway Improvements
  - Dividing Barriers
  - Existing Lane Designation / Flow
  - Proposed Lane Designation
  - Road Closure / Removal

Sources:  
 1. Aerial Photography - MAPA 2016  
 2. Concept - HDR 2017

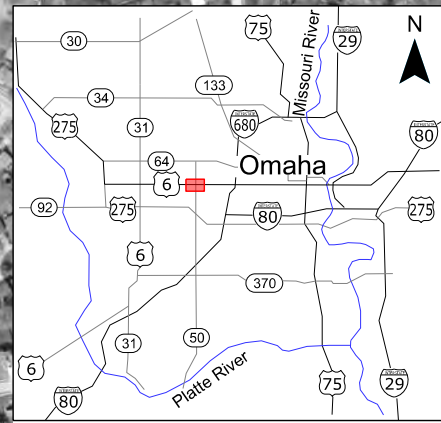

Key Map  
N.T.S.

**PRELIMINARY PLAN**  
 NOT FINAL - SUBJECT TO CHANGE



**6 WEST DODGE Recommended Concept**

March 2019

Metro Area Travel Improvement Study  
 Douglas and Sarpy County, Nebraska

Figure 4

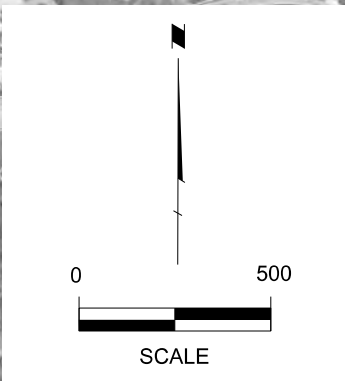
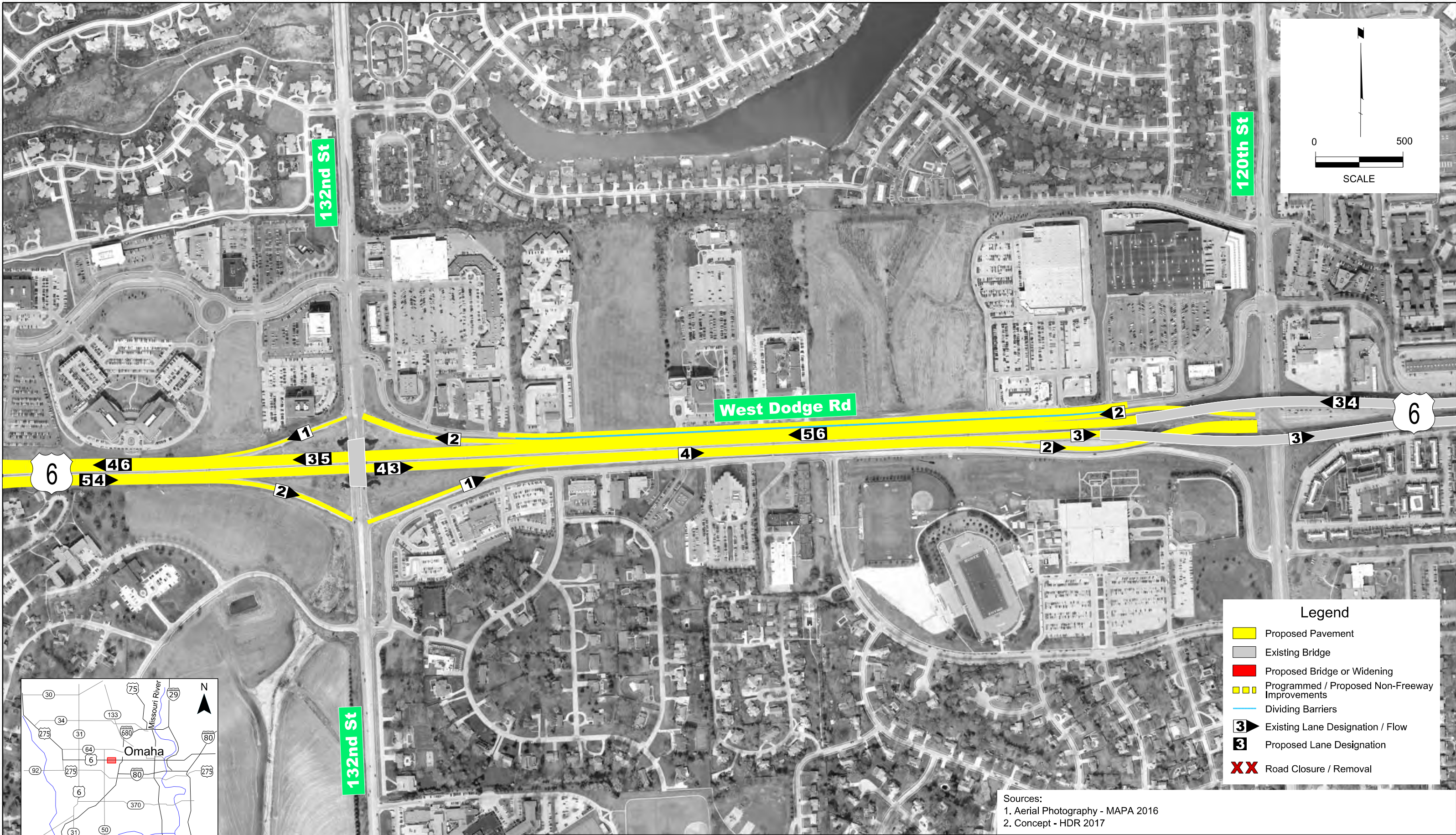

- Legend**
- Proposed Pavement
  - Existing Bridge
  - Proposed Bridge or Widening
  - Programmed / Proposed Non-Freeway Improvements
  - Dividing Barriers
  - Existing Lane Designation / Flow
  - Proposed Lane Designation
  - XX** Road Closure / Removal

Sources:  
 1. Aerial Photography - MAPA 2016  
 2. Concept - HDR 2017

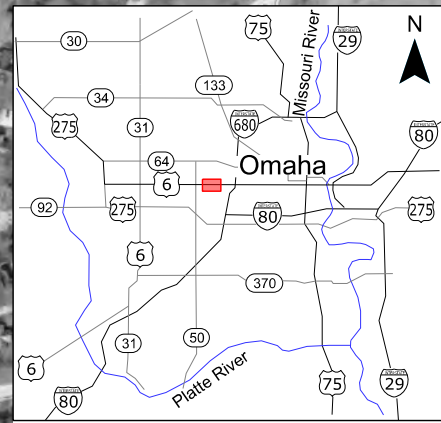

**PRELIMINARY PLAN**  
 NOT FINAL - SUBJECT TO CHANGE



**6 WEST DODGE Recommended Concept**  
 Metro Area Travel Improvement Study  
 Douglas and Sarpy County, Nebraska  
 March 2019  
 Figure 5

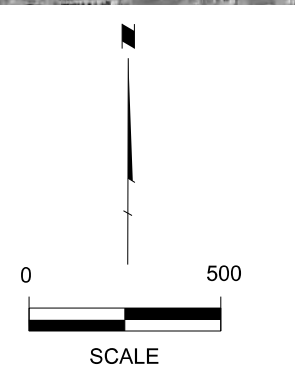
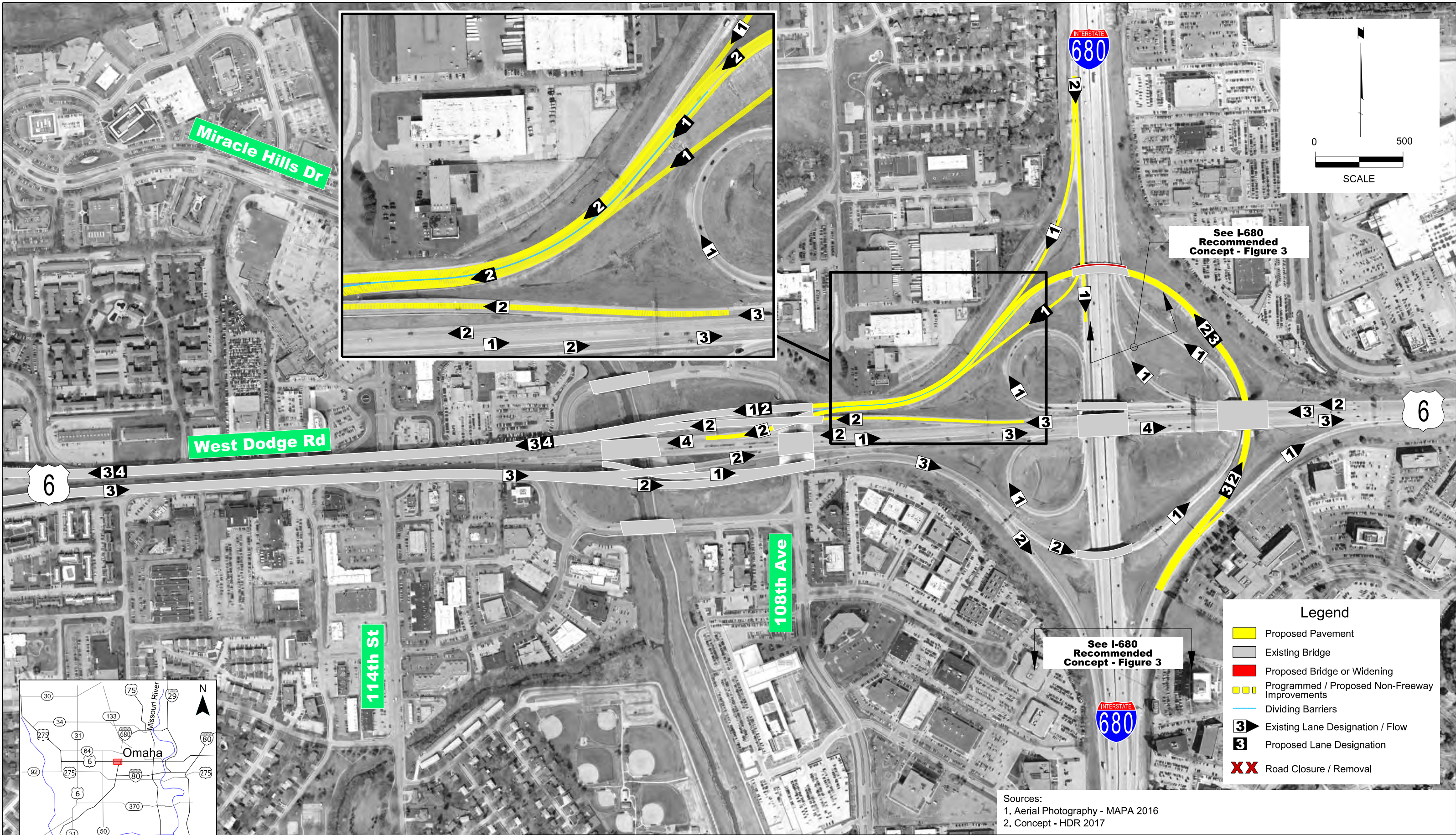

See I-680 Recommended Concept - Figure 3

See I-680 Recommended Concept - Figure 3

- Legend**
- Proposed Pavement
  - Existing Bridge
  - Proposed Bridge or Widening
  - Programmed / Proposed Non-Freeway Improvements
  - Dividing Barriers
  - 3 Existing Lane Designation / Flow
  - E Proposed Lane Designation
  - XX Road Closure / Removal

Sources:  
 1. Aerial Photography - MAPA 2016  
 2. Concept - HDR 2017

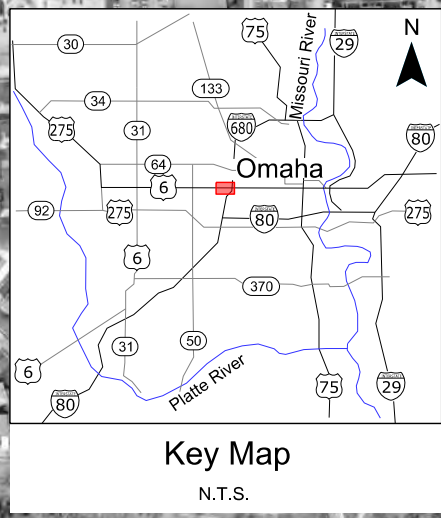

**PRELIMINARY PLAN**  
 NOT FINAL - SUBJECT TO CHANGE



<b>WEST DODGE Recommended Concept</b>  Metro Area Travel Improvement Study Douglas and Sarpy County, Nebraska	March 2019
	Figure 6

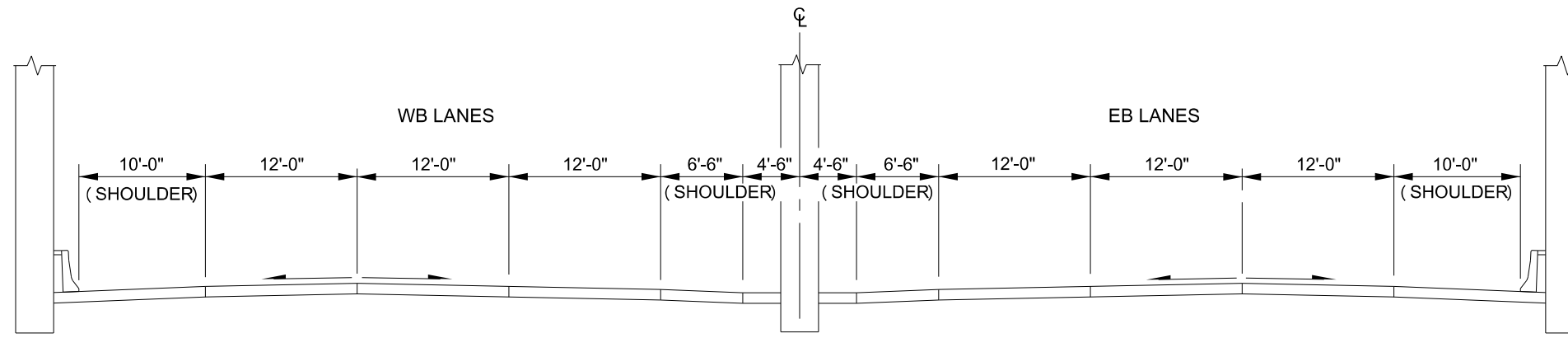

**WEST DODGE ROAD**  
 EXISTING CONDITIONS  
 WEST DODGE BRIDGE UNDERPASS  
 AT 156TH ST, 168TH AND 180TH ST

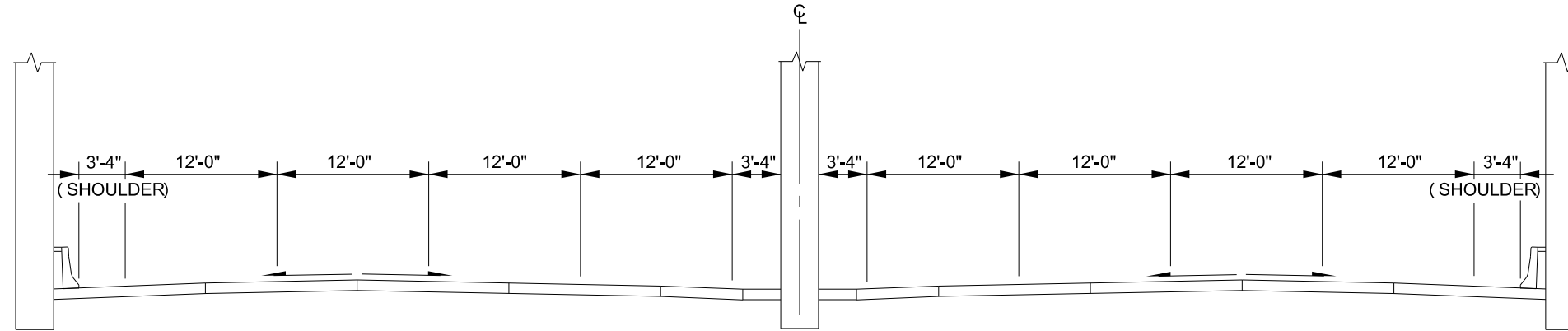

**WEST DODGE ROAD RECOMMENDED CONCEPT**  
 PROPOSED CONDITIONS  
 WEST DODGE BRIDGE UNDERPASS  
 AT 156TH, 168TH AND 180TH ST

**PRELIMINARY PLAN**  
 NOT FINAL - SUBJECT TO CHANGE



**6 WEST DODGE TYPICAL SECTIONS  
 BRIDGE UNDERPASS**  
 Metro Area Travel Improvement Study  
 Douglas and Sarpy County, Nebraska

March 2019

Figure 7



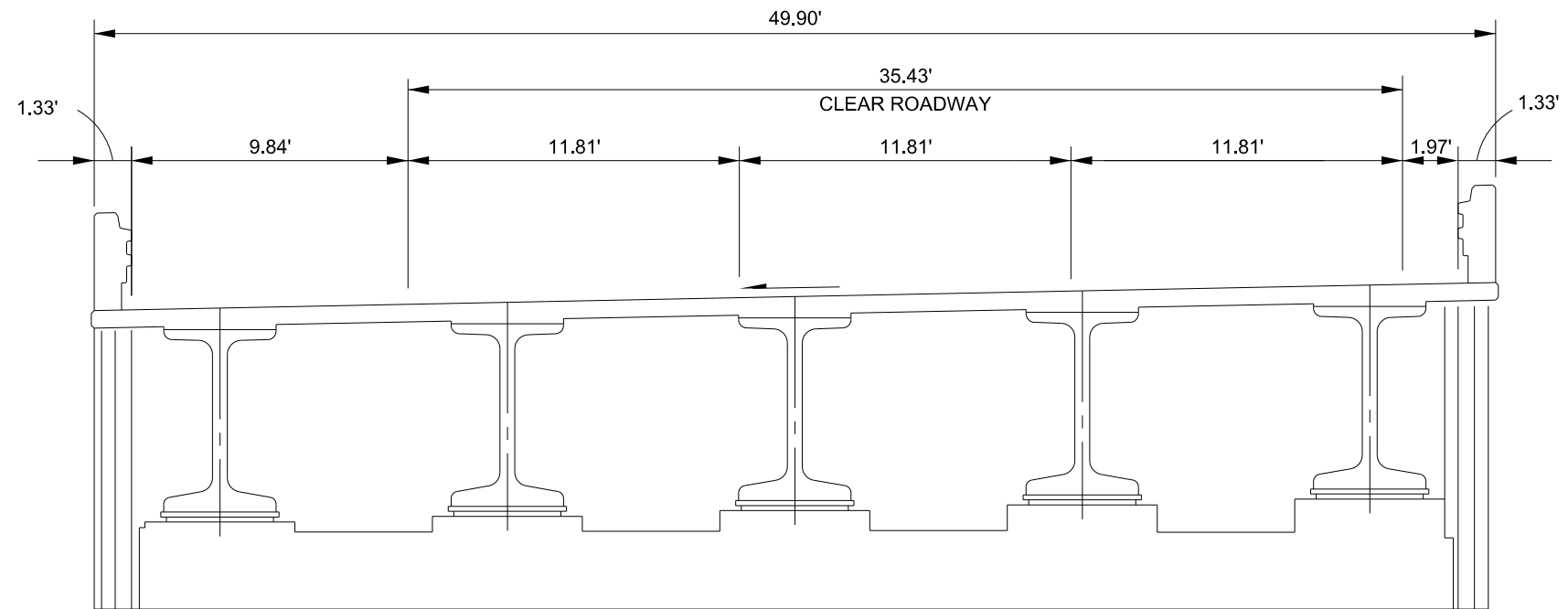

WEST DODGE ROAD WB EXPRESSWAY BRIDGE  
 EXISTING CONDITIONS  
 WB EXPRESSWAY BRIDGE

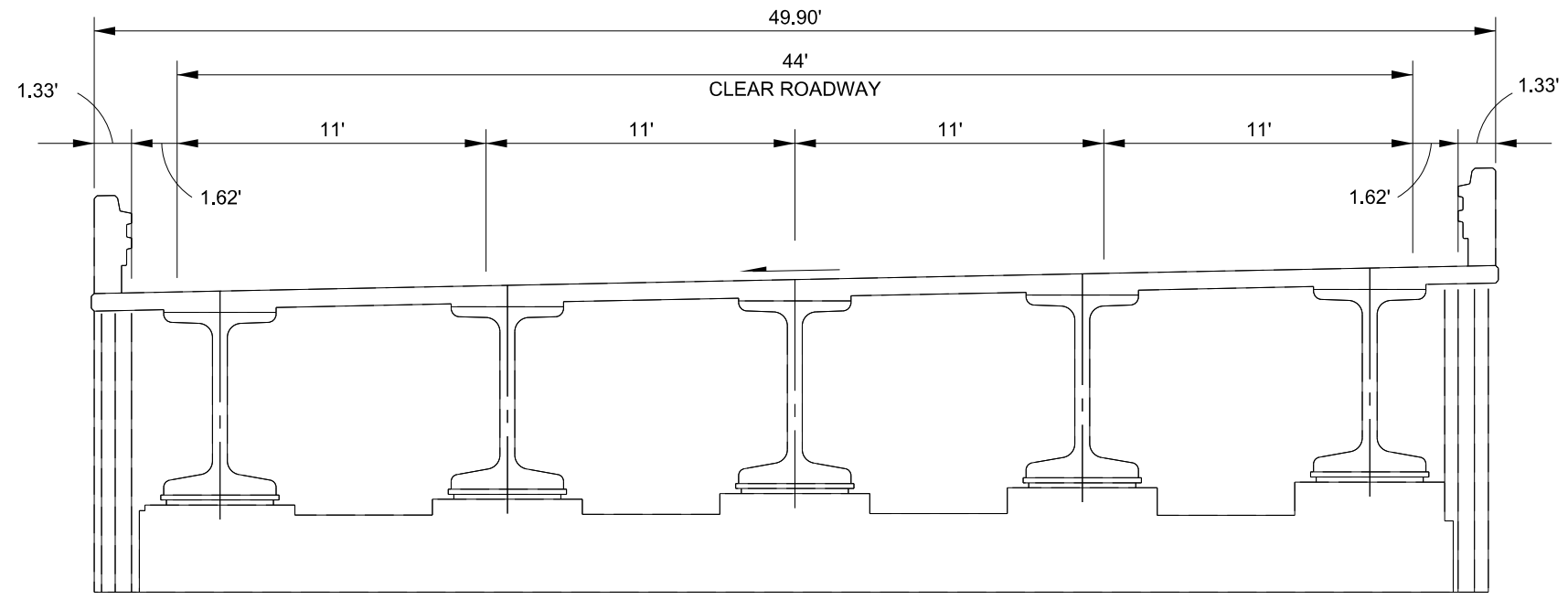

WEST DODGE ROAD WB EXPRESSWAY BRIDGE  
 CONVERTING TO FOUR LANE HIGHWAY  
 WITHOUT WIDENING

**PRELIMINARY PLAN**  
 NOT FINAL - SUBJECT TO CHANGE



6 WEST DODGE TYPICAL SECTIONS  
 WB EXPRESSWAY BRIDGE  
 Metro Area Travel Improvement Study  
 Douglas and Sarpy County, Nebraska

March 2019

Figure 8

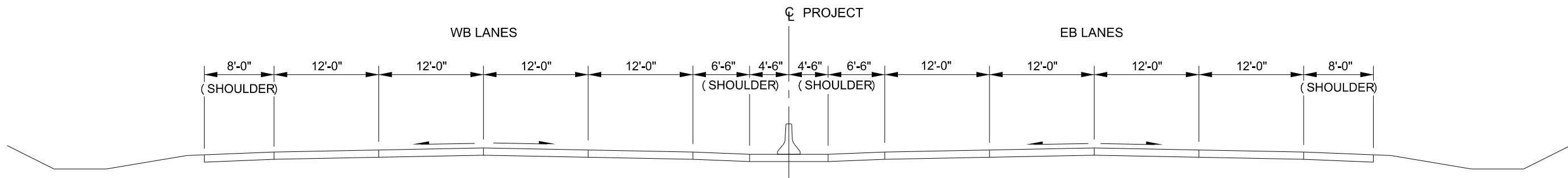

WEST DODGE ROAD

EXISTING CONDITIONS  
BETWEEN 150TH ST AND 144TH ST

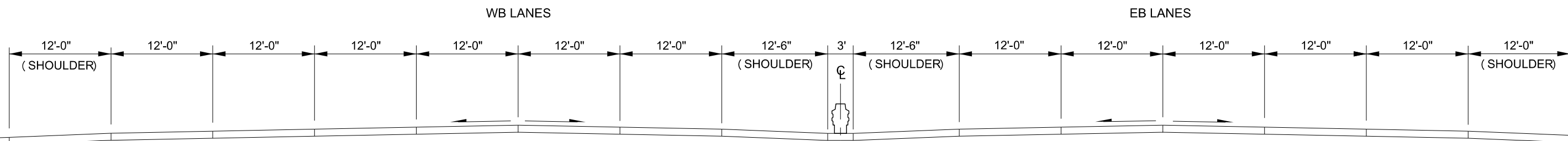

WEST DODGE ROAD ALTERNATIVE 1

PROPOSED CONDITIONS  
BETWEEN 150TH ST AND 144TH ST

**PRELIMINARY PLAN**  
NOT FINAL - SUBJECT TO CHANGE



**6** WEST DODGE TYPICAL SECTIONS  
Between 144TH ST AND 150TH ST  
Metro Area Travel Improvement Study  
Douglas and Sarpy County, Nebraska

March 2019

Figure 9